

THE UNIVERSITY OF CHICAGO

ARCHAEOLOGY AND HISTORICAL PROBLEMS OF THE
SECOND INTERMEDIATE PERIOD

VOLUME III

(Cont.)

A DISSERTATION SUBMITTED TO
THE FACULTY OF THE DIVISION OF THE HUMANITIES
IN CANDIDACY FOR THE DEGREE OF
DOCTOR OF PHILOSOPHY

DEPARTMENT OF NEAR EASTERN LANGUAGES
AND CIVILIZATIONS

BY

BRUCE WILLIAMS

CHICAGO, ILLINOIS

DECEMBER 1975

Fig. 142.--Burial Customs and Pottery Types From C-Group IIa

Bietak, Studien zur Chronologie der Nubischen C-Gruppe.

a. Plate 5

b. Plate 6

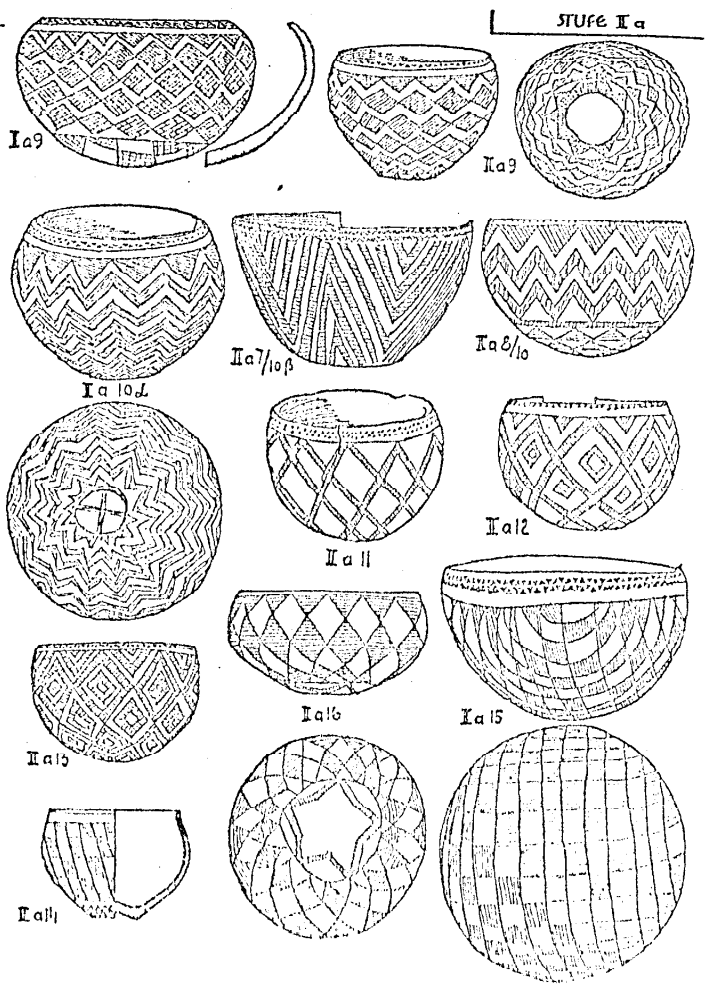
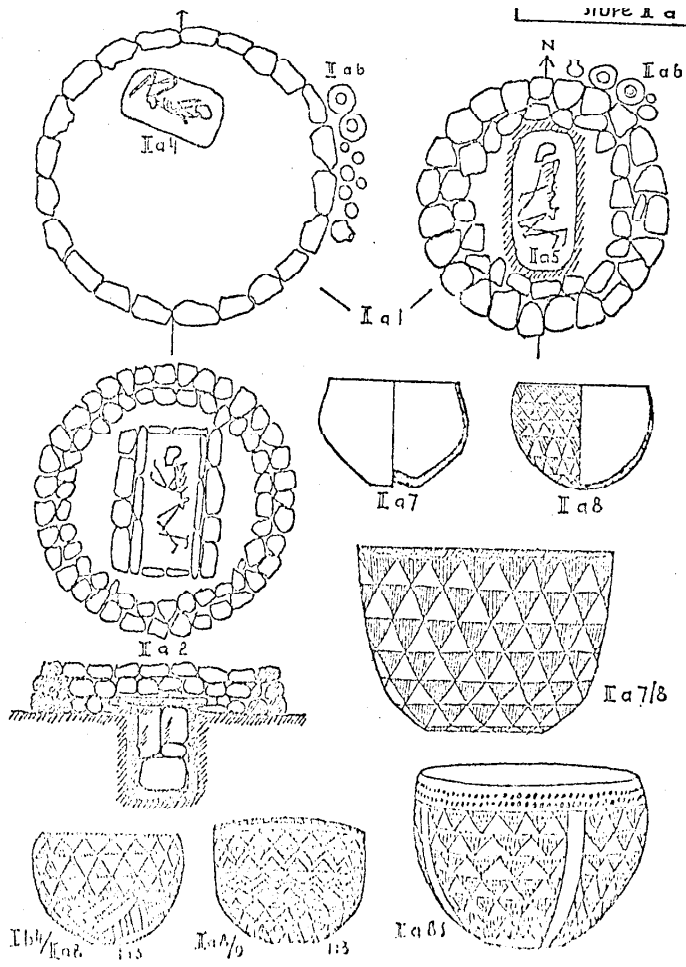

a

b

Fig. 143.--Pottery Types and Pan Grave Traits from C-Group IIa

Bietak, Studien zur Chronologie der Nubischen C-Gruppe.

a. Plate 7

b. Plate 8

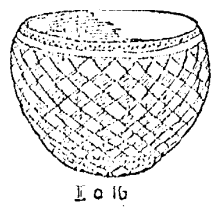

Ia 16



Ia 17a

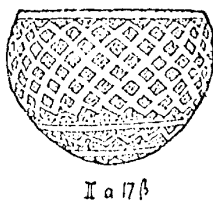

Ia 17b



Ia 18a

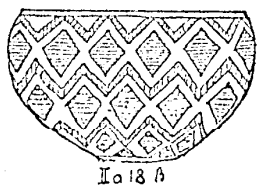

Ia 18b



Ia 19

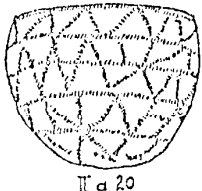

Ia 20

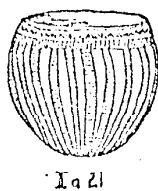

Ia 21

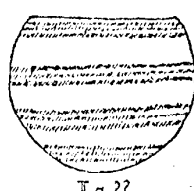

Ia 22

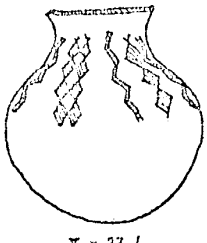

Ia 23a

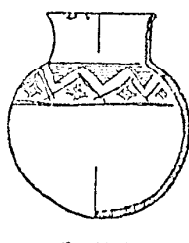

Ia 23b

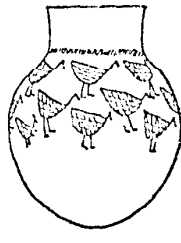

Ia 23c

STUFE IIa

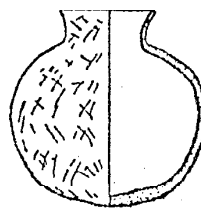

Ia 23d

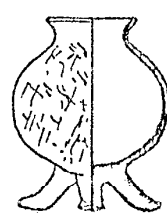

Ia 23e



Ia 23f

STUFE IIa



Ia 24a



Ia 24b



Ia 24c

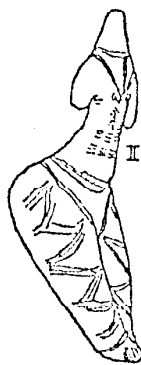

Ia 25a



Ia 25b



Ia 25c

Ia 26

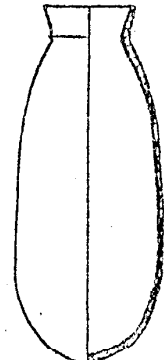

a

AUFTRETEN VON
PAN-GROVE-BEISSEN
IN L-GRUPPEN-GRÄBERN



P 15



P 15

b

Fig. 144.--Burial Customs and Pottery Types from C-Group IIb

Bietak, Studien zur Chronologie der Nubischen C-Gruppe.

a. Plate 11

b. Plate 12

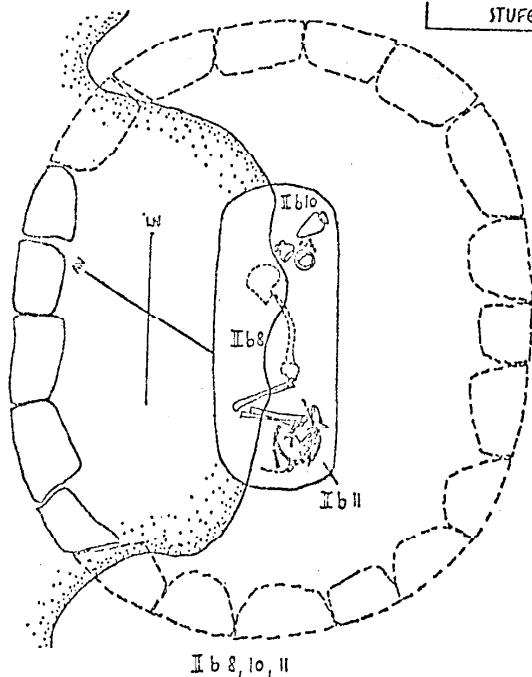

Иб 8, 10, 11

STUFE II b

STUFE II b



Иб 12 б



Иб 12 в



Иб 13 а

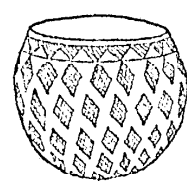

Иб 13 б



Иб 13 в

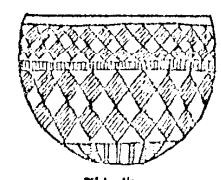

Иб 14

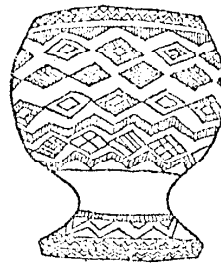

Иб 16 а

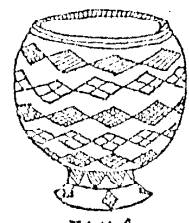

Иб 16 б

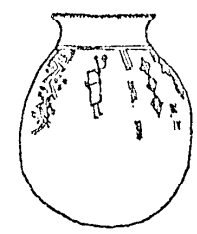

Иб 17

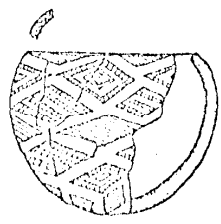

Иб 12 а

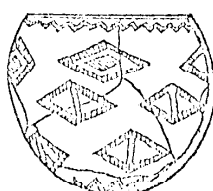

Иб 12 в

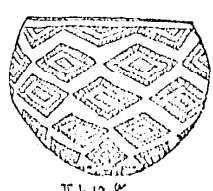

Иб 12 г



Иб 18 а



Иб 18 б

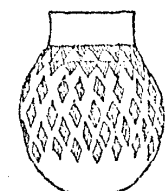

Иб 18 в



Иб 18 г

a

b

Fig. 145.--C-Group IIb and III

Bietak, Studien zur Chronologie der Nubischen C-Gruppe.

- a. Pottery and objects from C-Group IIb Plate 13
- b. Burial customs, pottery and objects from C-Group III
Plate 14

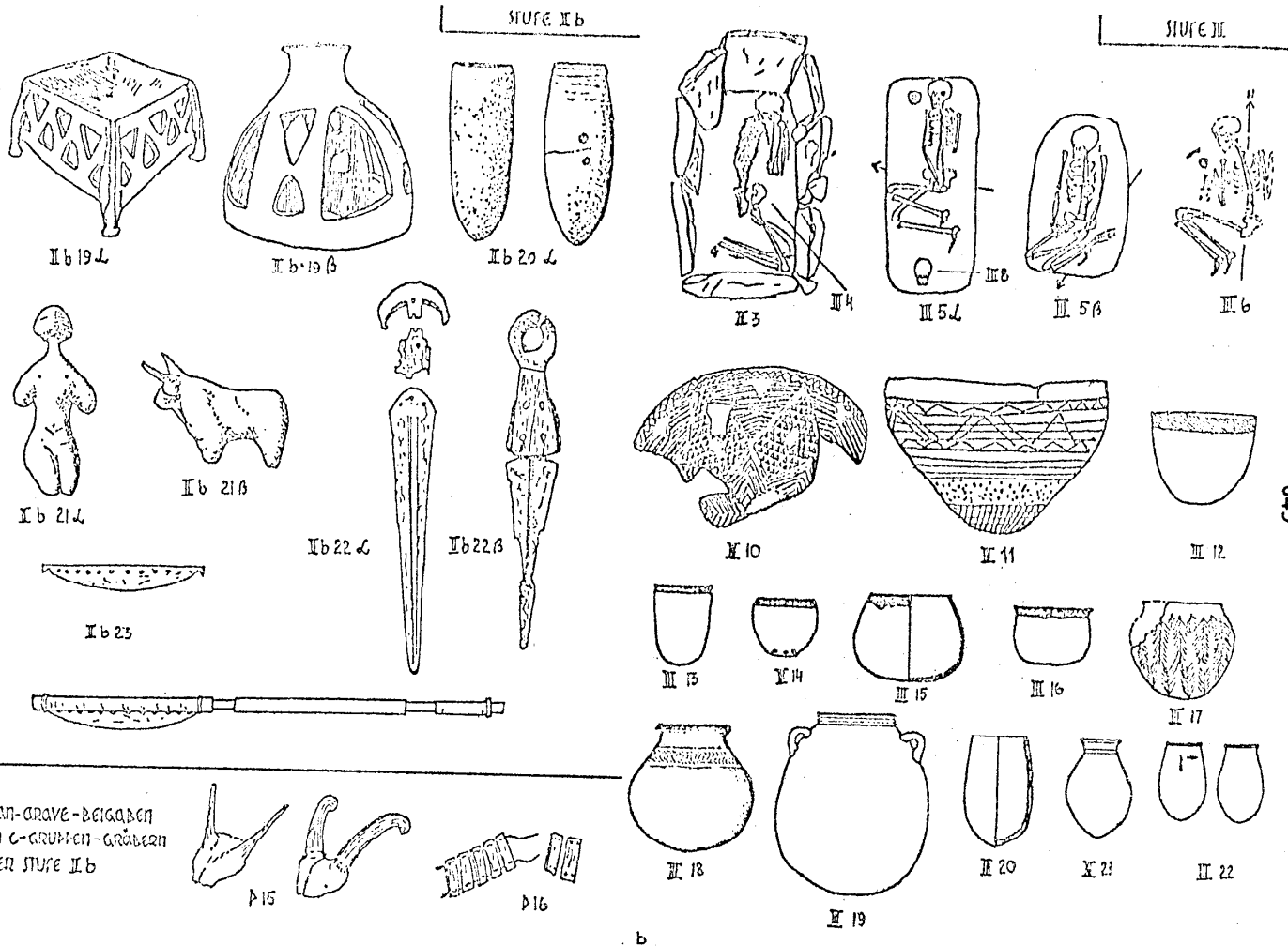

STUFE II b

STUFE III

645

von-grave-beigaben
in c-gruben-gräbern
der stufe II b

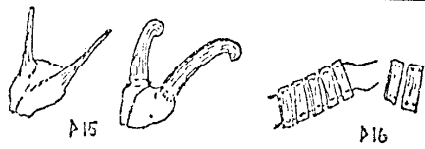

a

b

Fig. 146.--Aniba: C-Group Settlement Plan
Steindorff, Aniba; Erster Band, Fig. 15.

Fig. 147.--Aniba: Architecture of the C-Group

Steindorff, Aniba; Erster Band.

a. Fig. 21

b. Fig. 19

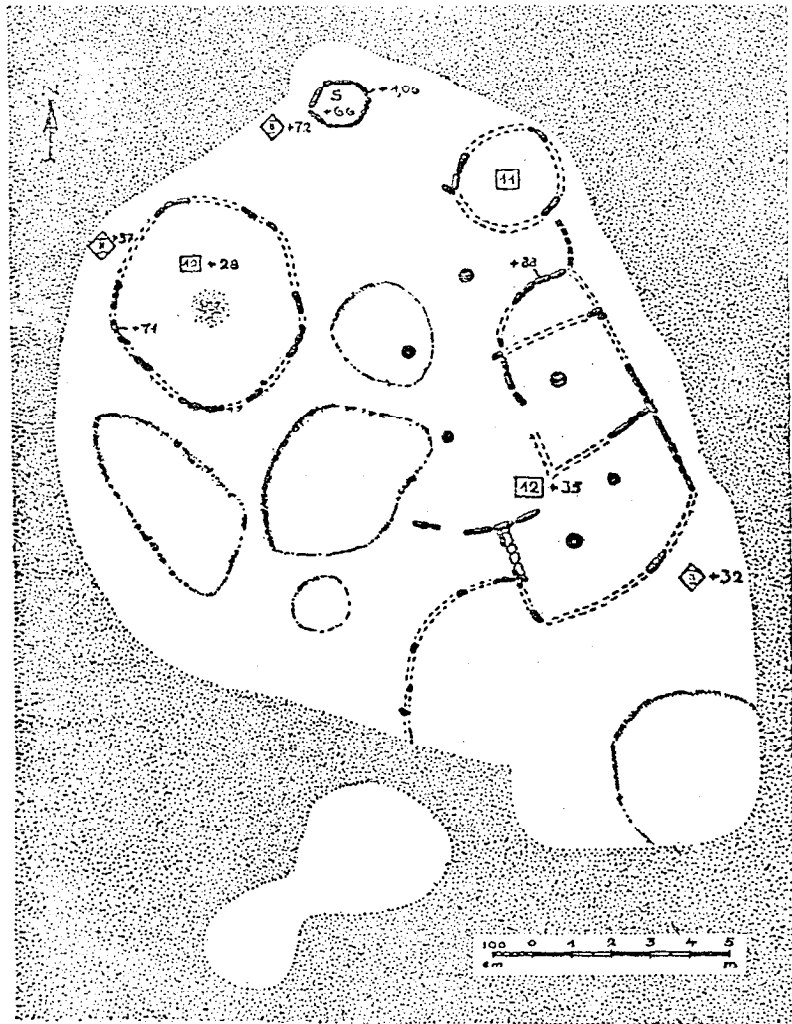

a

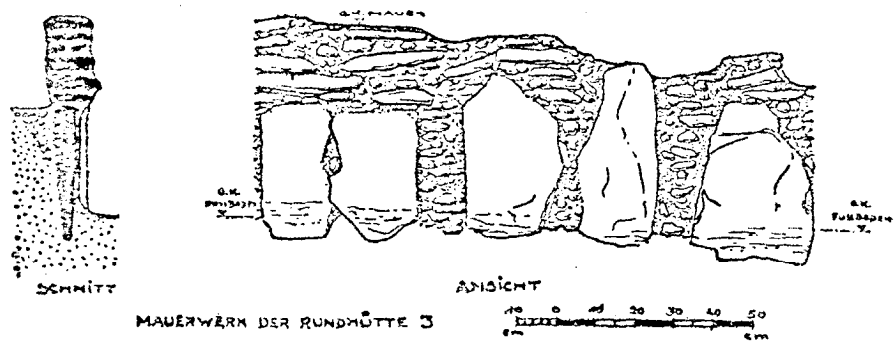

b

Fig. 148.--Wadi Es Sebuá East: The Plan of the Fortified Settlement

Serge Sauneron, "Un village nubien Fortifié sur la rive orientale de Ouadi es-Sébou," Bulletin de l'Institut Français Archeologie Orientale du Caire, Vol. 63 (1965), p. 163.

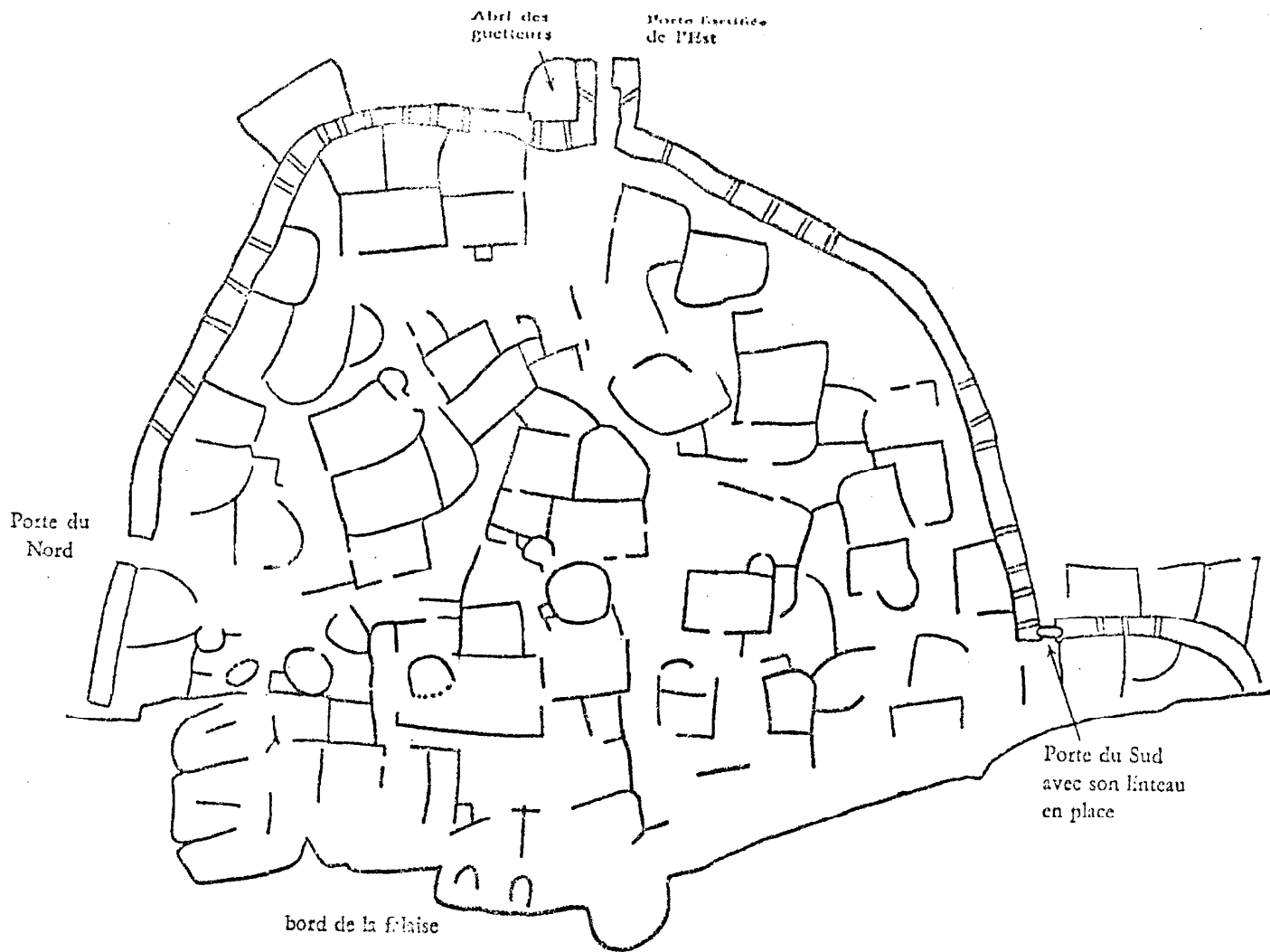

Fig. 149.--Egyptian Fortresses of the Middle Kingdom and Major Areas of C-Group Settlement

1. Ikkur
2. Kubban
3. Aniba
4. Faras
5. Serra East
6. Buhen
7. Mirgissa

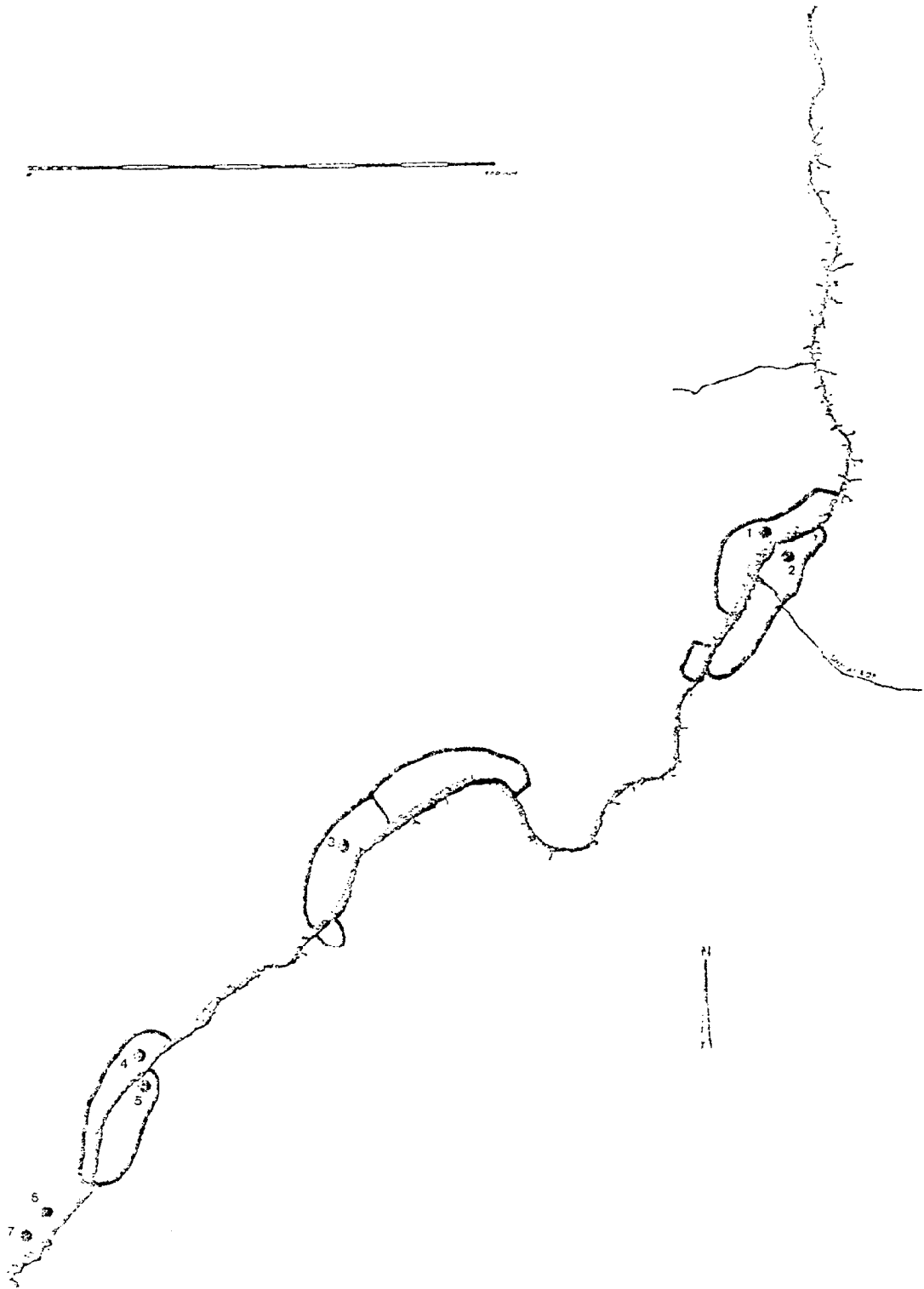

Fig. 150.--The Occurrence of C-Group Ia, after Bietak

1. Dakka, Cemetery 97
2. Dakka, Cemetery 101
3. Qurta, Cemetery 118
4. Sayala
5. Aniba, Cemetery N
6. Aba Simbel, Cemetery 215
7. Faras
8. Adindan, Cemetery T
9. Debeira (a dubious occurrence)

NOTE: A doubtful occurrence of Gerf Husein in Cemetery 73 is omitted.

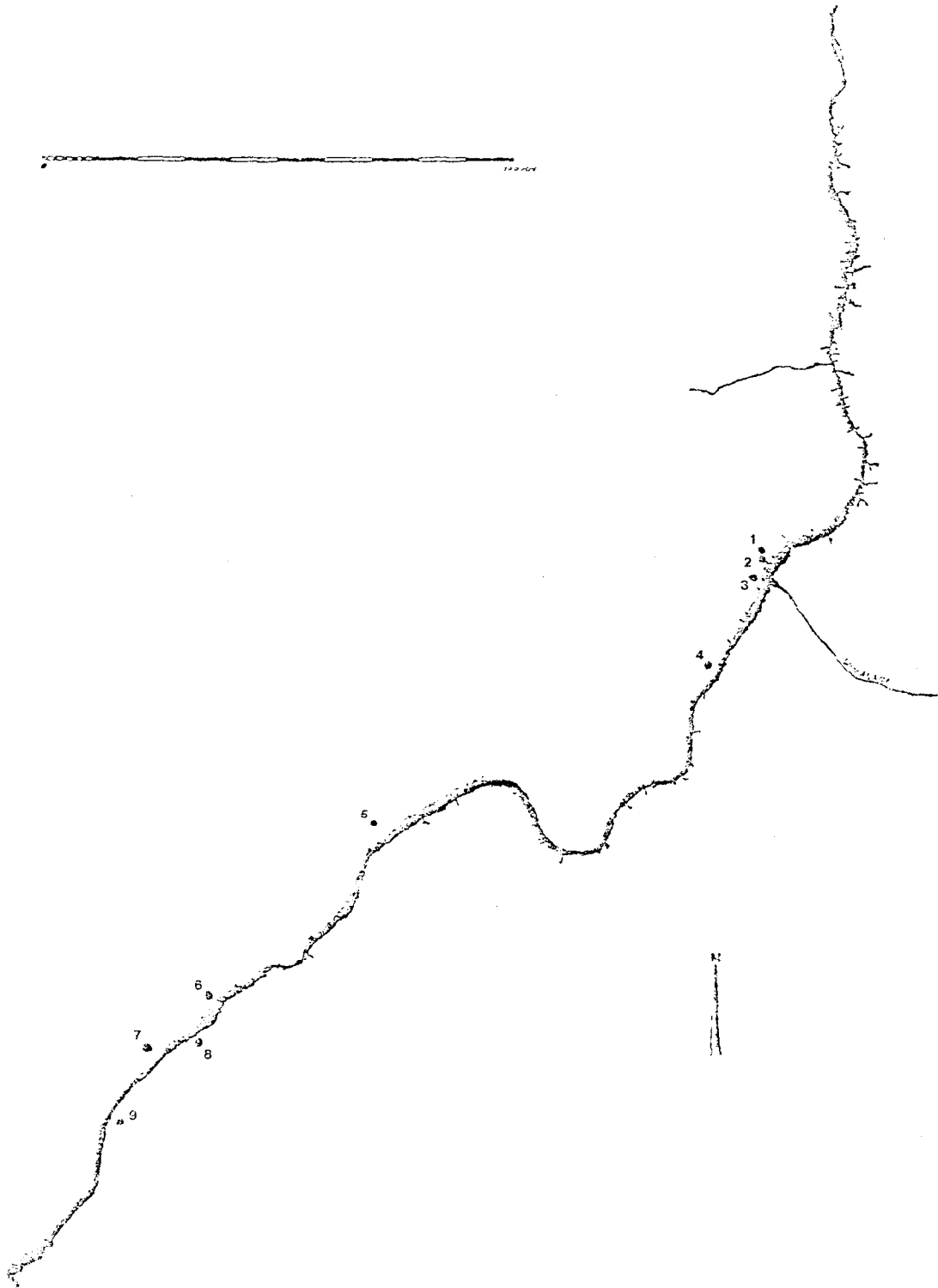

Fig. 151.--The Occurrence of C-Group Ib, after Bietak

1. Kubaniua North
2. Koshtamna, Cemetery 87
3. Dakka, Cemetery 97
4. Dakka, Cemetery 101
5. Qurta, Cemetery 115
6. Qurta, Khor Nabruk
7. Qurta, Cemetery 118
8. Wadi Alaqi, Cemetery 114
9. Maharraqa
10. Tumas, Cemetery 189
11. Aniba, Cemetery N
12. Aniba, Cemetery SS
13. Aniba, Cemetery 200
14. Toshka, Cemetery 209
15. Toshka, Cemetery 210
16. Faras
17. Adindan

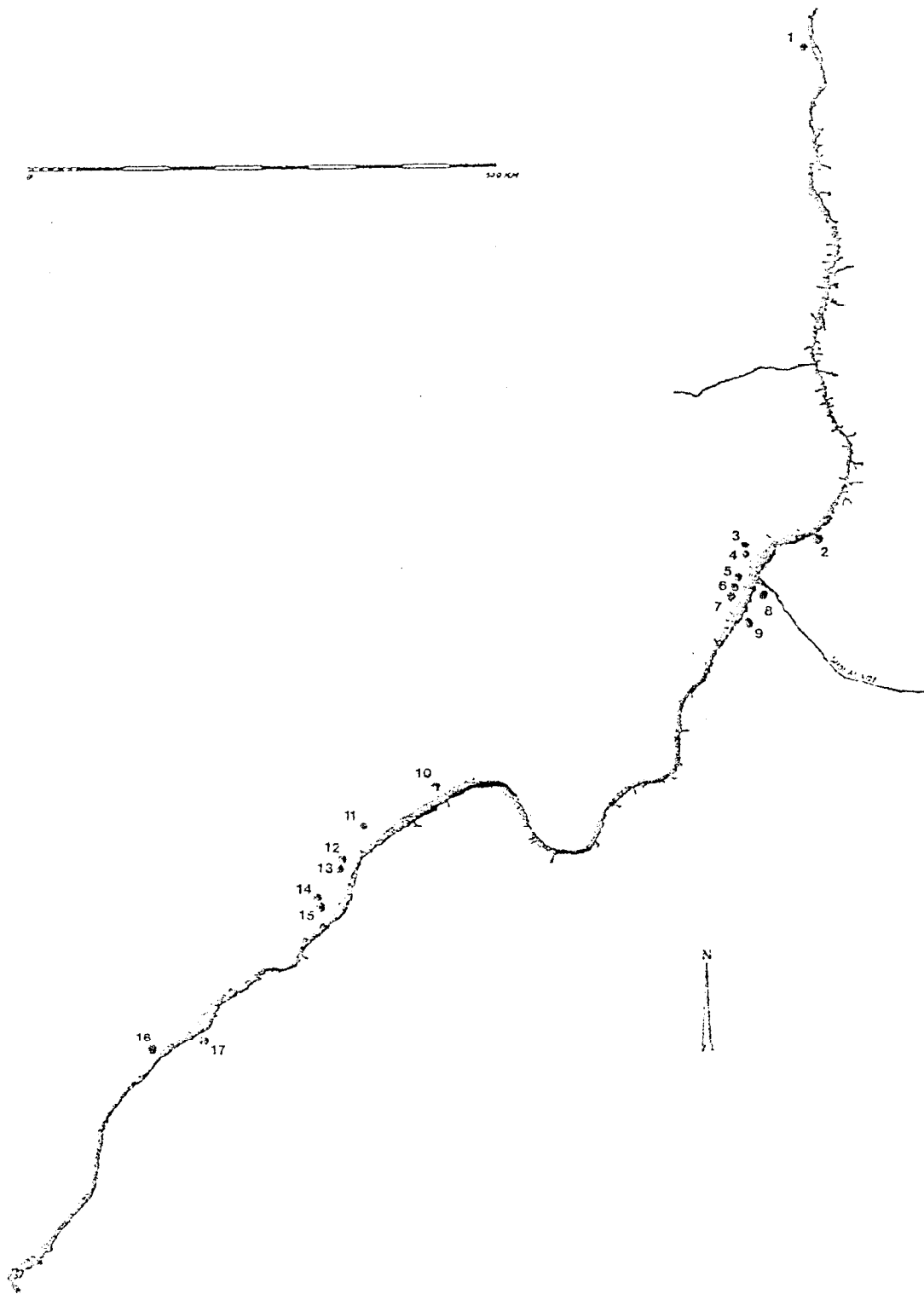

Fig. 152.--The Occurrence of C-Group IIa, After Bietak

1. Kubaniyya North
2. Meris Markos
3. Ginari, Cemetery 58:100
4. Gerf Husein, Cemetery 72:200
5. Koshtamna, Cemetery 87
6. Dakka, Cemetery 97
7. Dakka, Cemetery 101
8. Qurta, Cemetery 115
9. Qurta, Khur Nabruk
10. Qurta, Cemetery 118
11. Wadi Alaqi, Cemetery 114
12. Maharraqa, Cemetery 127
13. Wadi es-Sebua, Cemetery 151
14. Riqa, Cemetery 167
15. Tamas, Cemetery 189
16. Aniba, Cemetery N
17. Aniba, Cemetery 195
18. Aniba, Cemetery 200
19. Toshka, Cemetery 209
20. Toshka, Cemetery 210
21. Adindan Cemetery I
22. Adindan Cemetery K
23. Faras
24. Faras, Cemetery 24 E 3

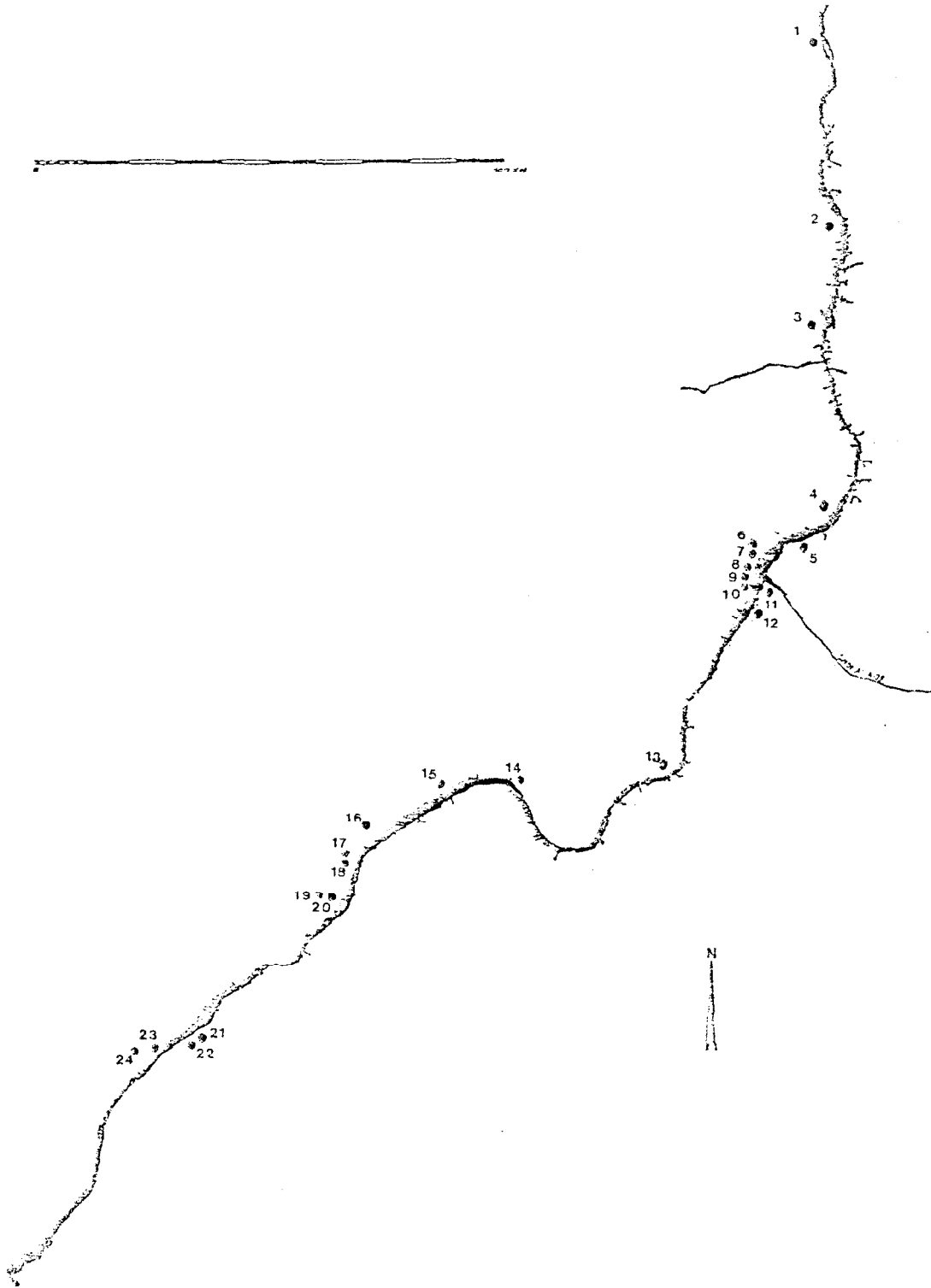

Fig. 153.--The Occurrence of C-Group IIb, After Biatak

1. Ginari
2. Koshtamna
3. Dakka, Cemetery 101
4. Qurta, Cemetery 115
5. Qurta, Cemetery 115
6. Riqa, Cemetery 167
7. Aniba, Cemetery N
8. Aniba, Cemetery 195
9. Aniba, Cemetery 200
10. Toshka, Cemetery 209
11. Adindan (Possibly both cemeteries K and T, not distinguished here)
12. Faras (Two cemeteries, including 24 E3; not distinguished here)
13. Gezira Dabarosa 6/G/13



Fig. 154.--The Occurrence of C-Group III, After Bietak

1. Ginari, Cemetery 58:100
2. Mc'alla, Cemetery 68, 69 N and S
3. Dakka, Cemetery 94
4. Kubban, Cemetery 110
5. Wadi Alaqi, Cemetery 111
6. Wadi Alaqi, Cemetery 113:1
7. Wadi Alaqi, Cemetery 113:50
8. Riqa, Cemetery 167
9. Afya, Cemetery 181
10. Tumas, Cemetery 189
11. Aniba, Cemetery B
12. Aniba, Cemetery 195
13. Aniba, Cemetery 200
14. Aniba, Cemetery 201
15. Toshka, Cemetery C500, 501, 503
16. Arminna Cemetery
17. Ashkeit, Cemetery 97
18. Gezira Dabarosa, 32 and 6/G/18

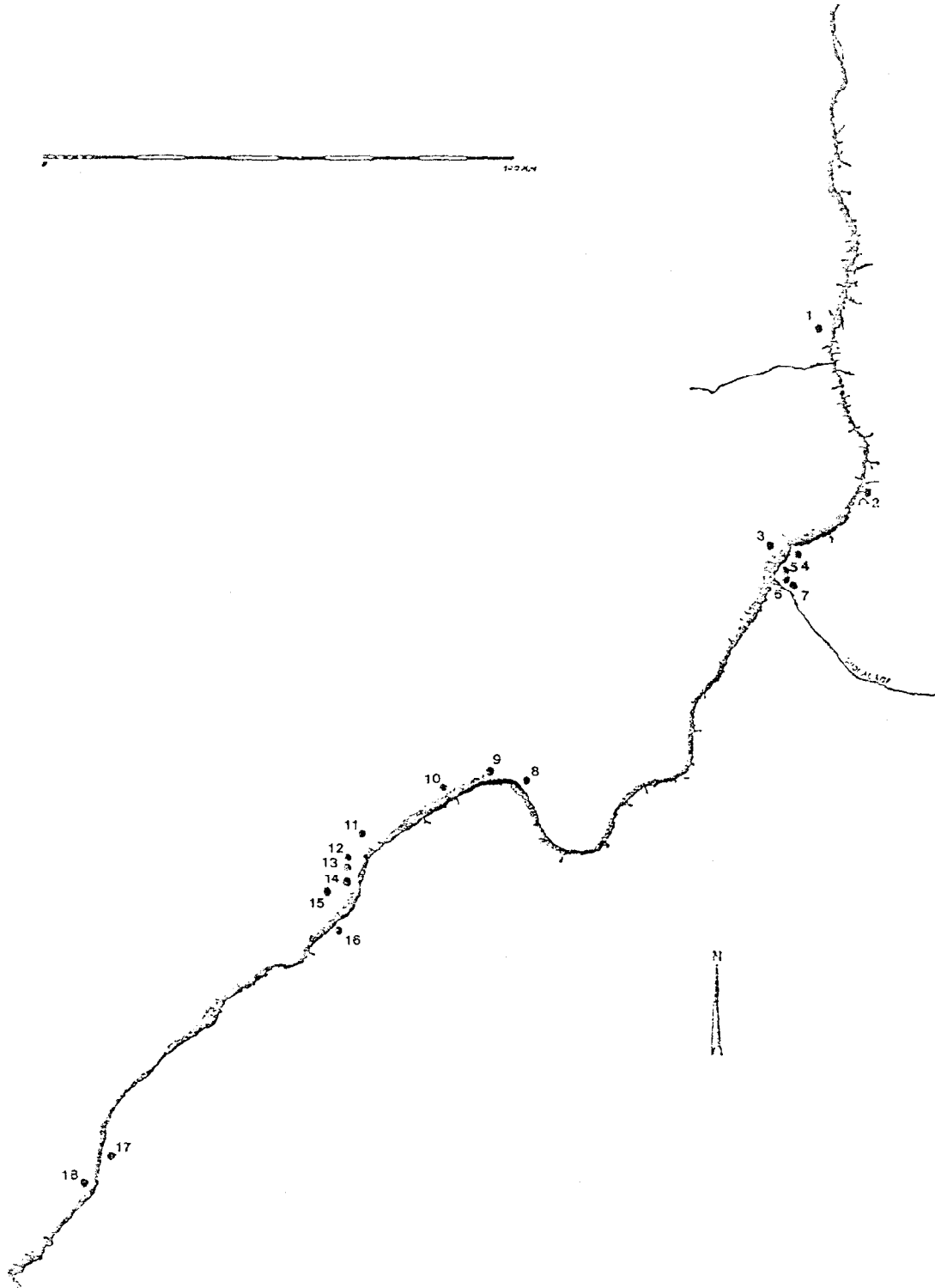

Fig. 155.--Kerma: Cemetery B

Reisner, Excavations at Kerma, Parts I-III, Plan II

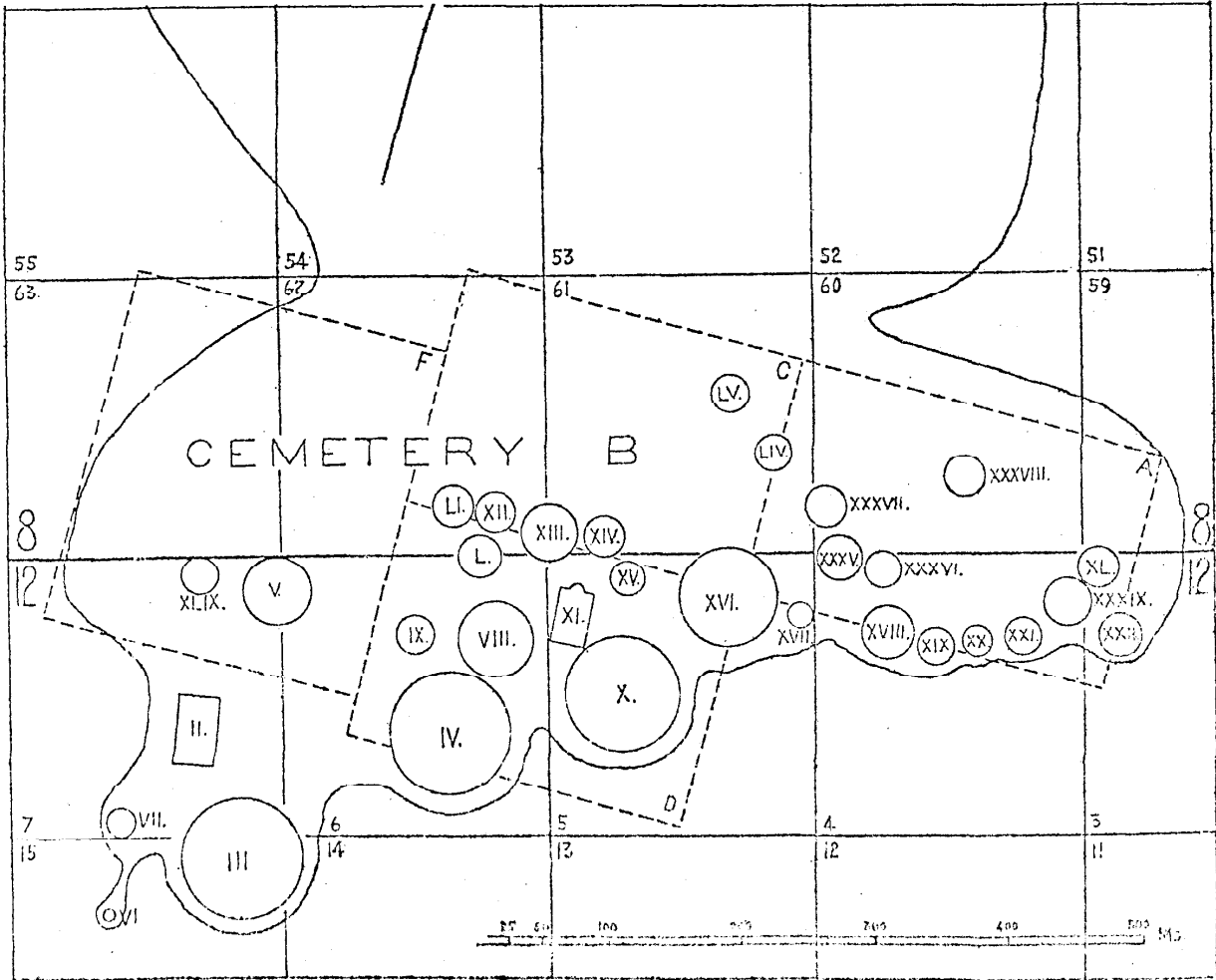
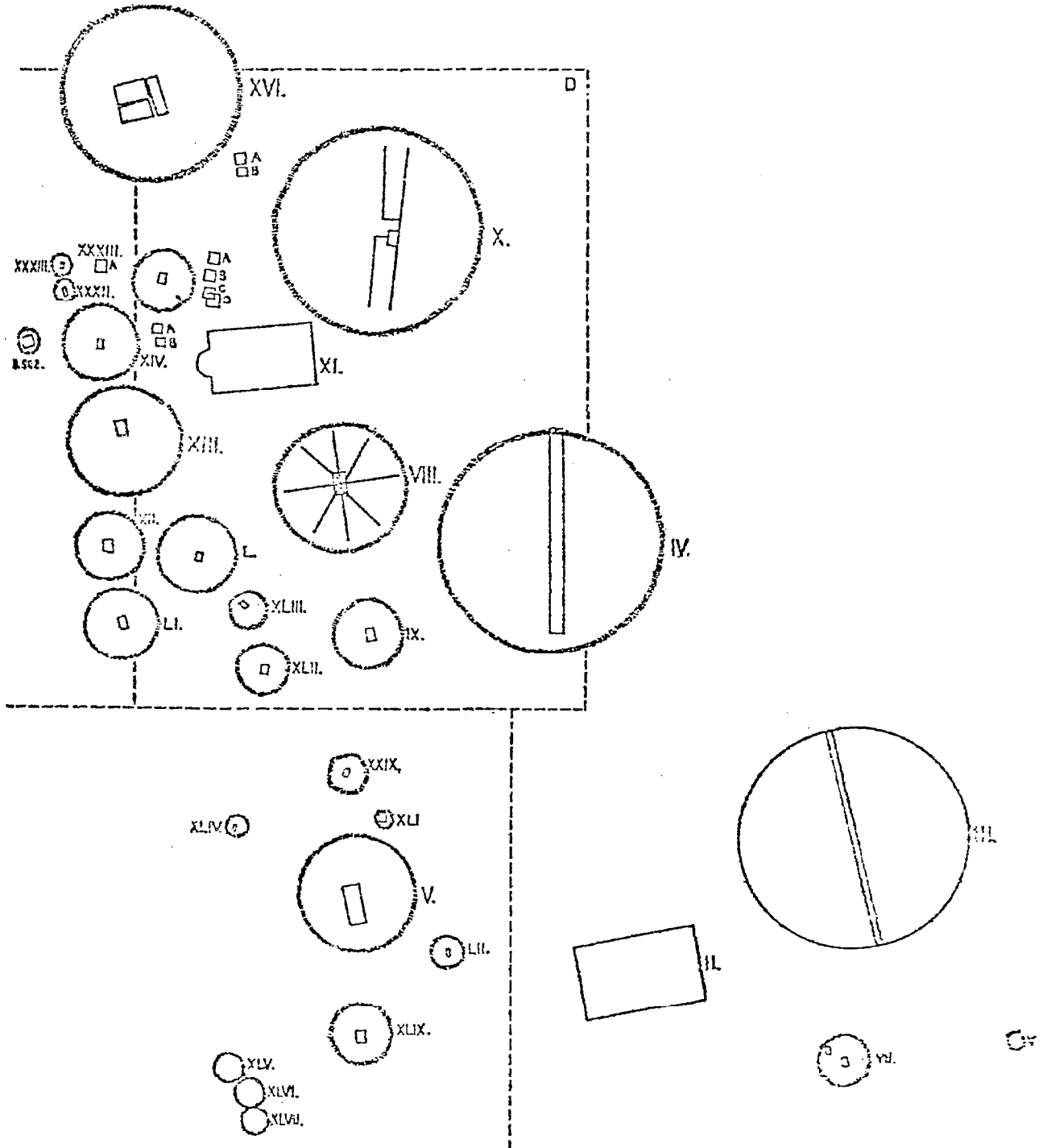
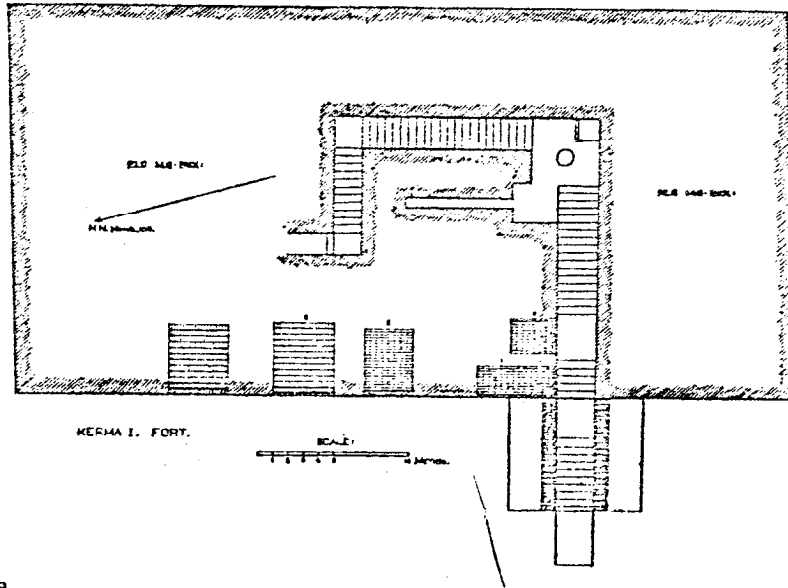

Fig. 156.--Kerma: The Four Great Tumuli from Cemetery B
Reisner, Excavations at Kerma, Parts I-III, Plan III.



- Fig. 157.--Kerma: The Lower Deffufa
- Reisner, Excavations at Kerma, Parts I-III.
- a. Plan Plan VIII
 - b. Section Plan IX



a

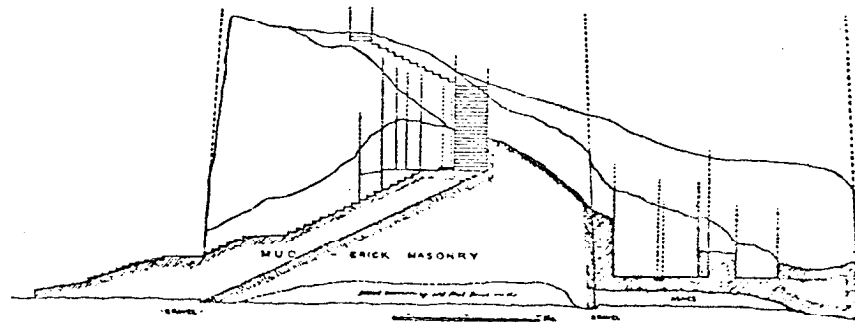

b

Fig. 158.--Kerma: Buildings West of the Lower Deffufa
Reisner, Excavations at Kerma, Parts I-III, Plan X.

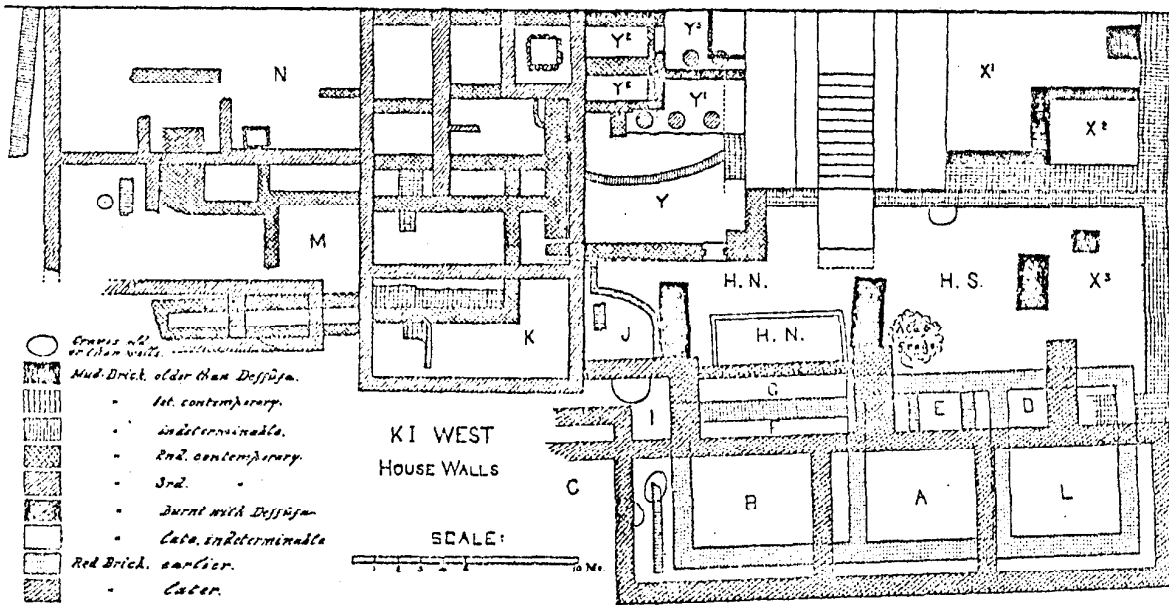
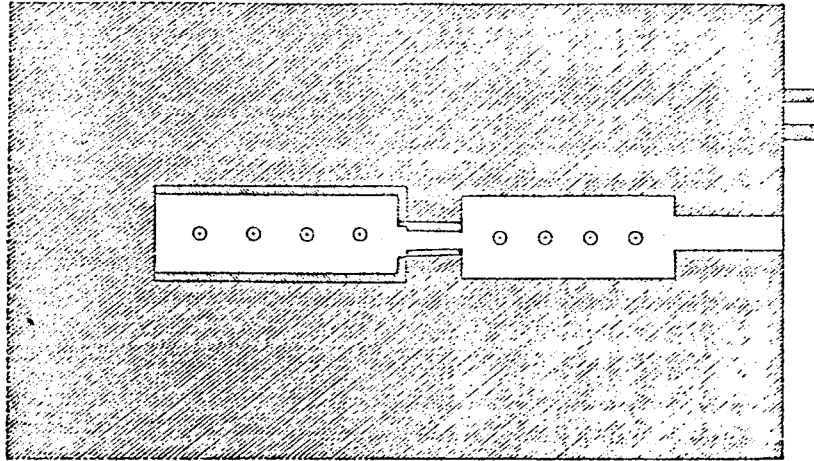
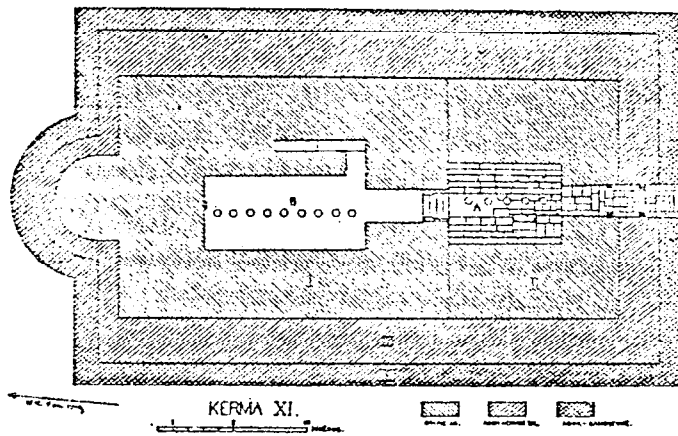

Fig. 159.--Kerma: Mortuary Temples in Cemetery B
Reisner; Excavations at Kerma, Parts I-III.

- a. The "Upper Deffufa" Plan XIII
- b. XXI Plan XIX



a



b

Fig. 160.--Kerma: Tumuli

Reisner, Excavations at Kerma, Parts I-III.

a. KIII Plan XV

b. KIV Plan XVII

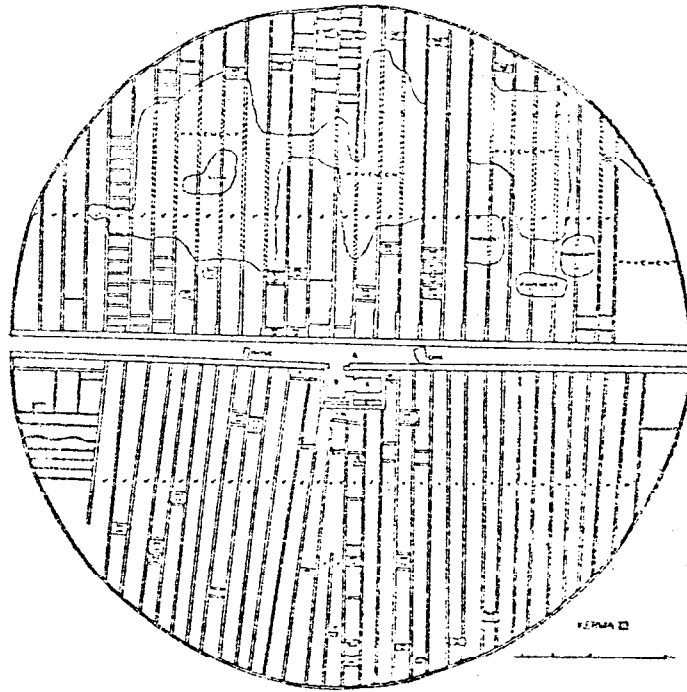

a

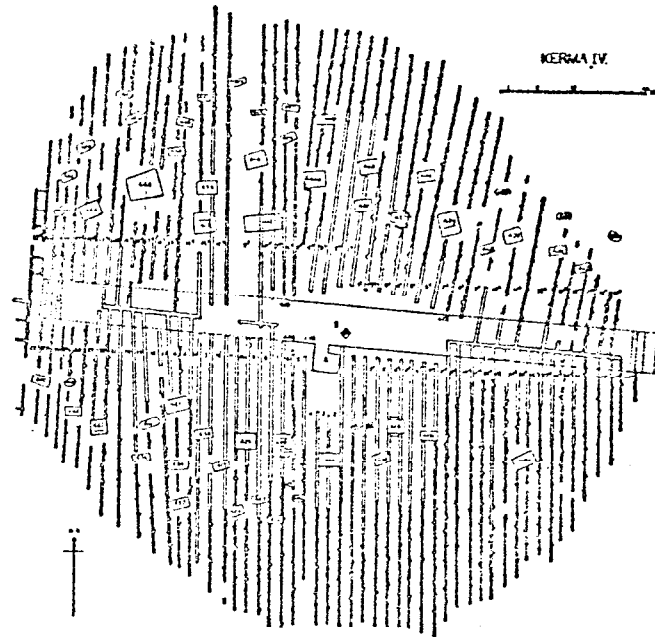

b

Fig. 161.--Kerma: Tumuli (Cont.)

Reisner; Excavations at Kerma, Parts I-III.

a. KX Plan XXI

b. KYVI Fig. 136

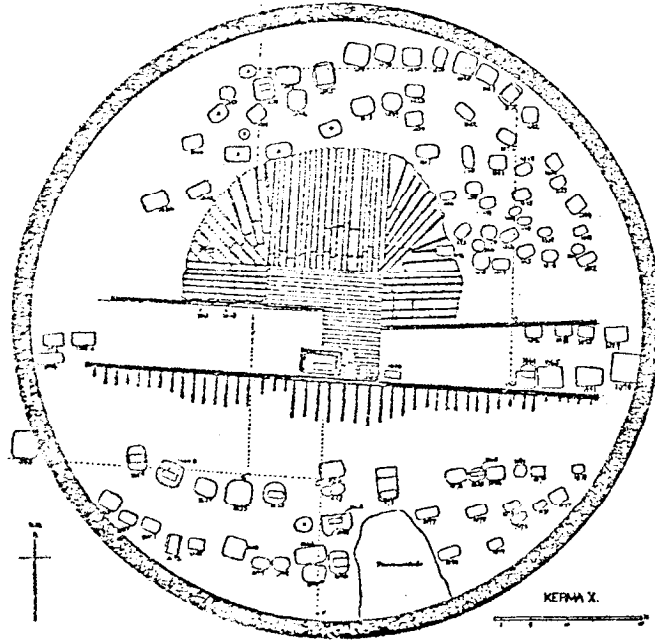

a

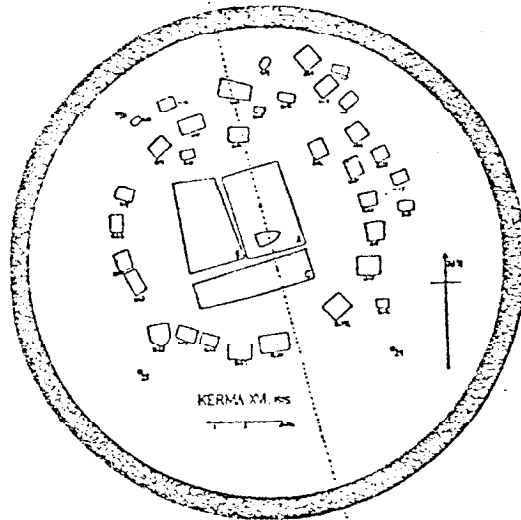

b

Fig. 162.--Kerma: Selected Pottery from the Lower Deffufa

Reisner, Excavations at Kerma, Parts I-III

a. Fig. 1

b. Fig. 2

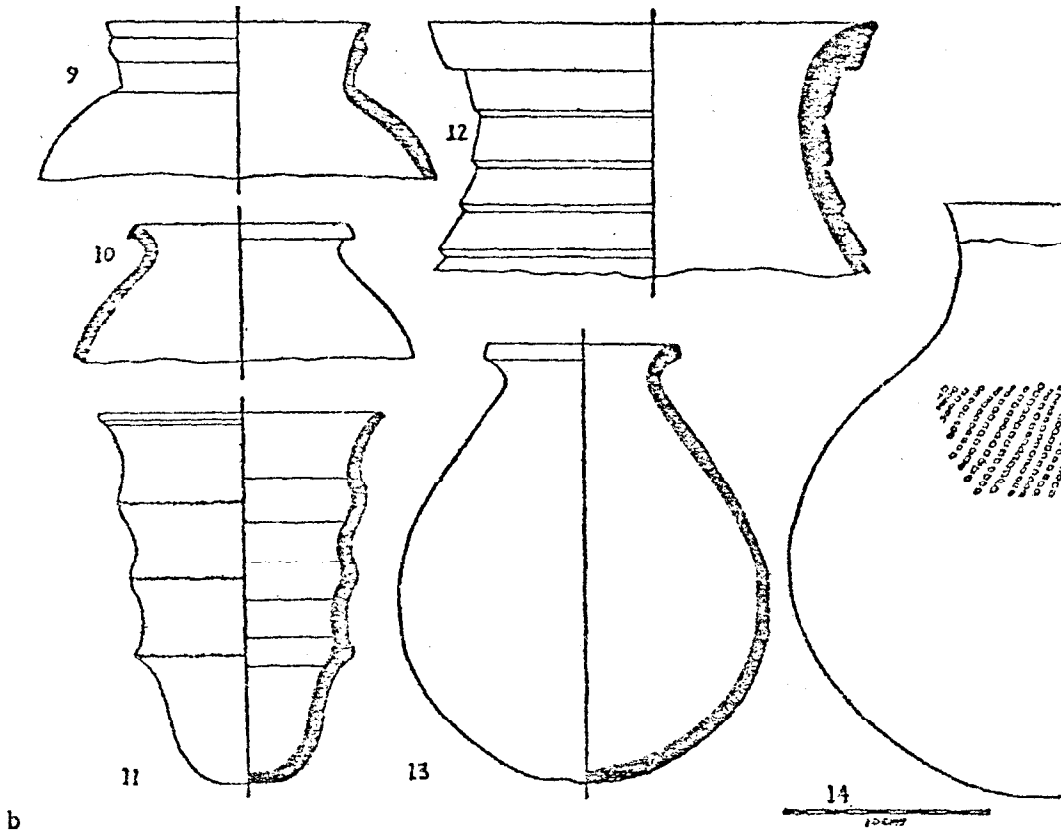
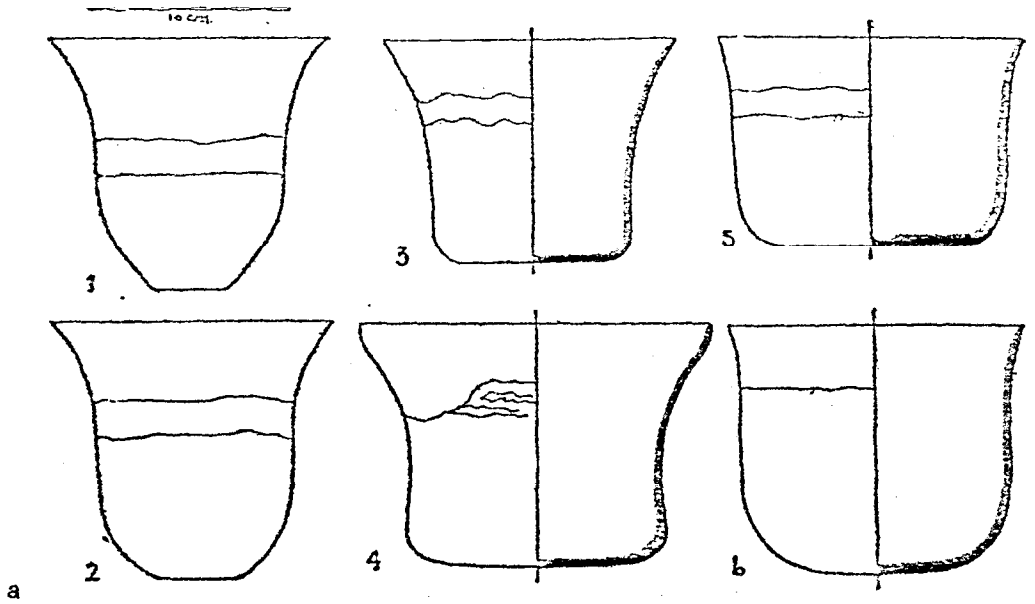

Fig. 163.--Kerma: Pottery from the Lower Deffufa (Cont.)

Reisner, Excavations at Kerma, Parts I-III, Fig. 3

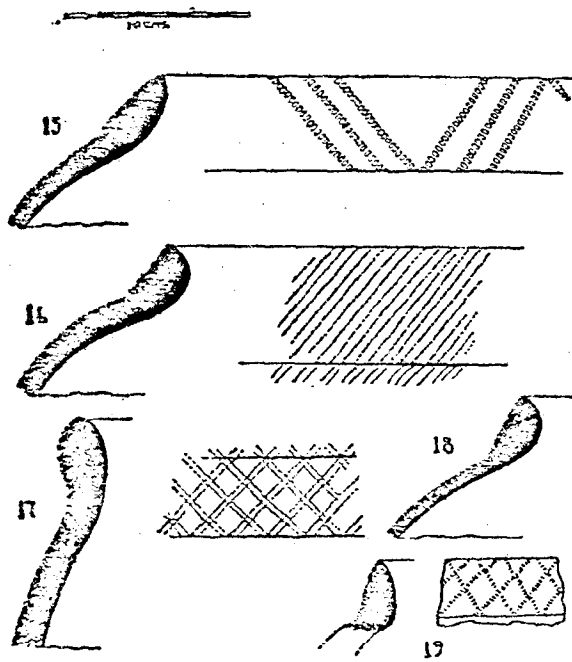
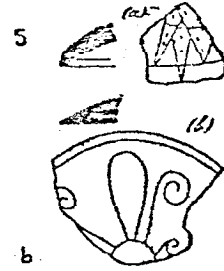
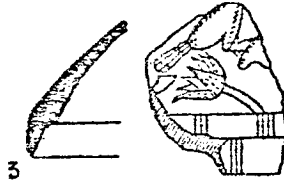
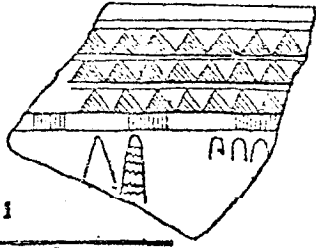
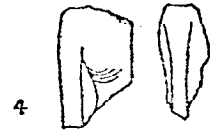
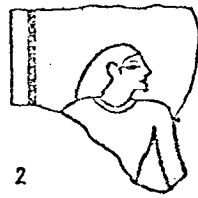
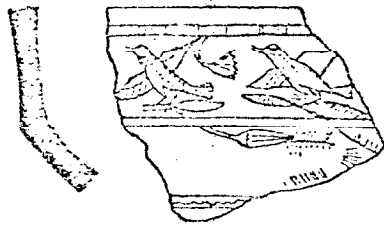

Fig. 164.--Kerma: Pottery from the Lower Deffufa (Cont.)

Reisner, Excavations at Kerma, Parts I-III.

- | | |
|----------------------------|--------|
| a. Decorated Faiences | Fig. 4 |
| b. Black incised (WJ) Ware | Fig. 5 |
| c. "Grey Ware" | Fig. 9 |

683



a

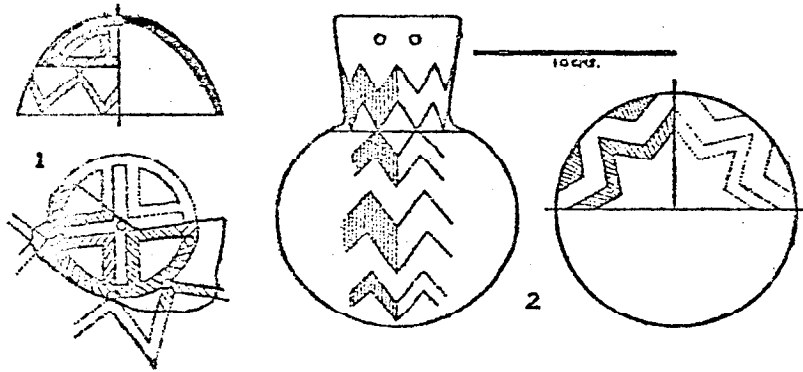

b

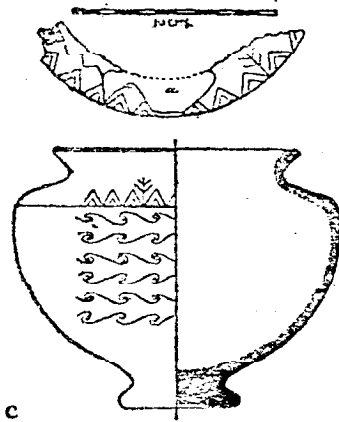

c

Fig. 165.--Kerma: Incised Pottery from the Lower Deffufa

Reisner; Excavations at Kerma, Parts I-III.

a. Fig. 10

b. Fig. 11

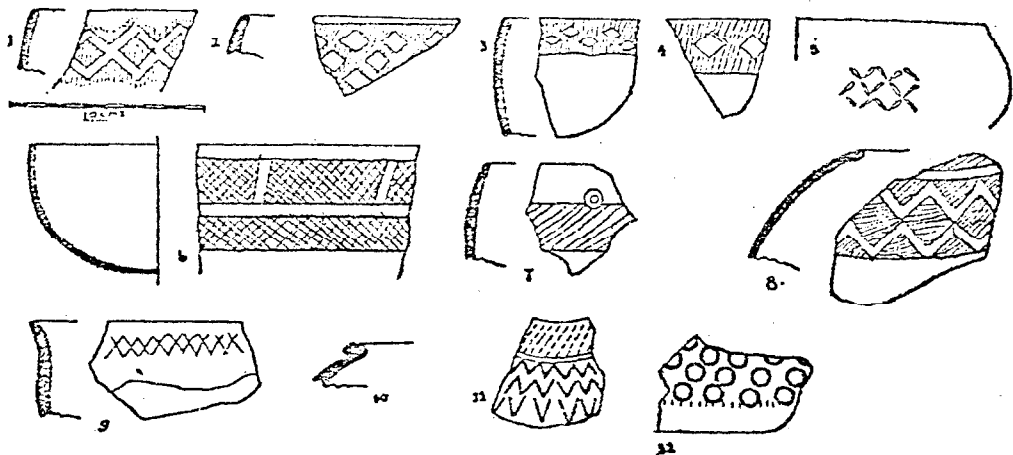

a

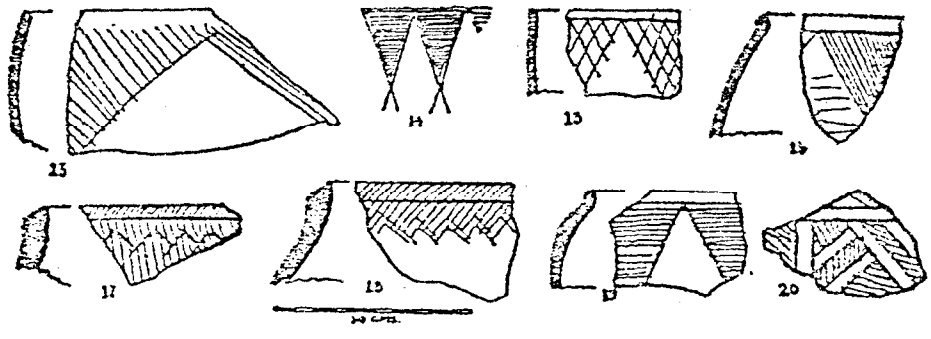

b

Fig. 166.--Kerma: Ivory Inlays

Reisner, Excavations at Kerma, Part IV-V, Plate 54.

a. No. 1

b. No. 2

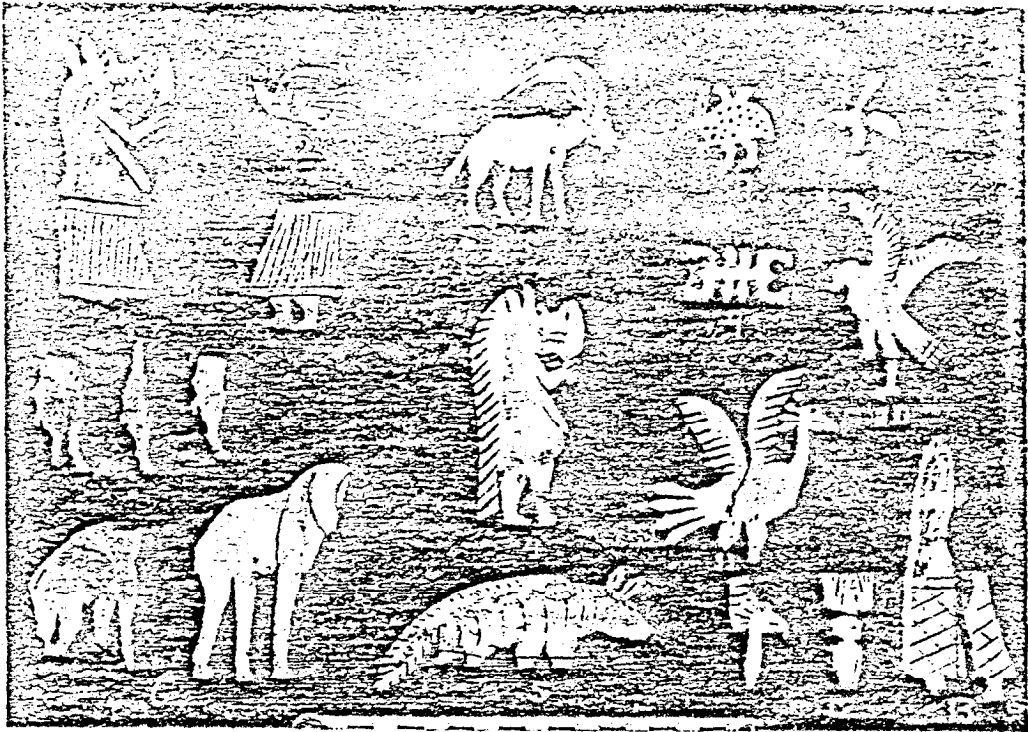

a

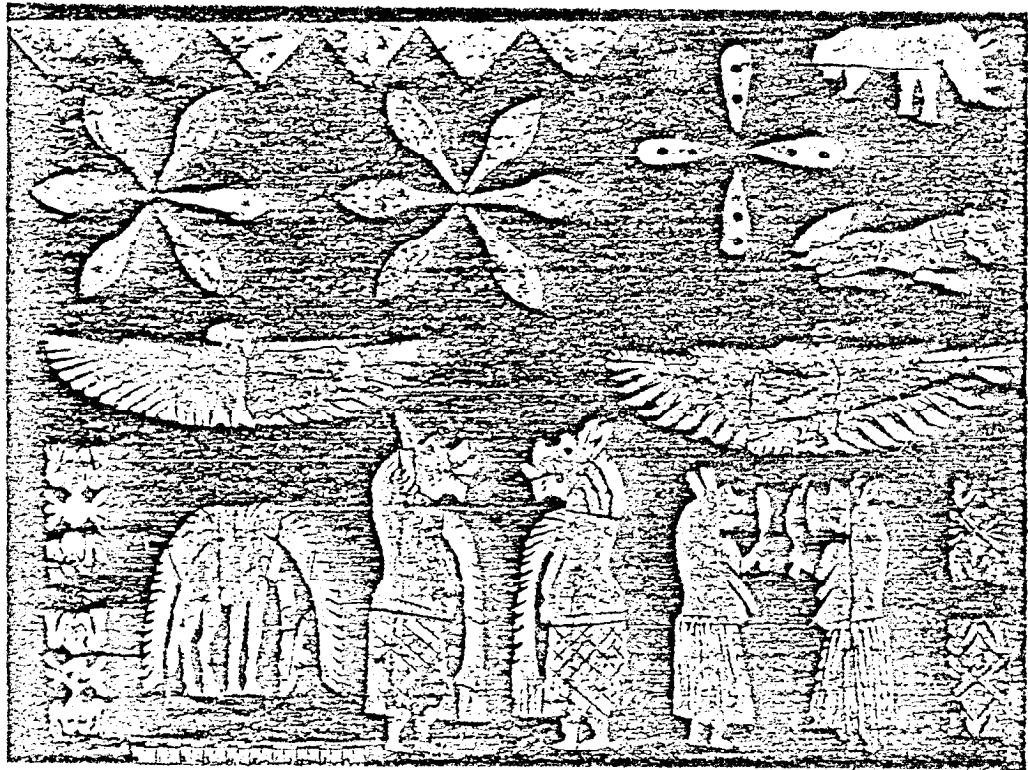

b

Fig. 167.--Kerma: Inlays

Reisner, Excavations at Kerma, Parts IV-V, Plate 54.

- a. Ivory inlays No. 1
- b. Inlaid footboard No. 4

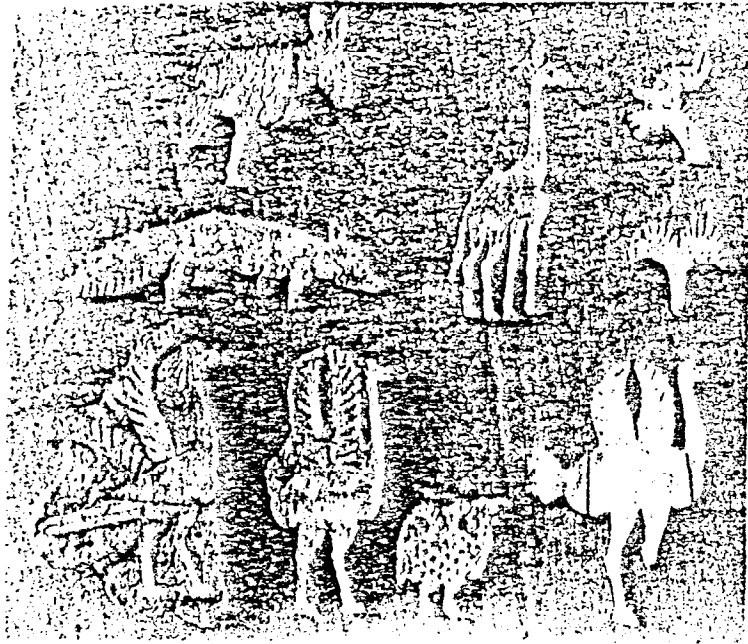

a

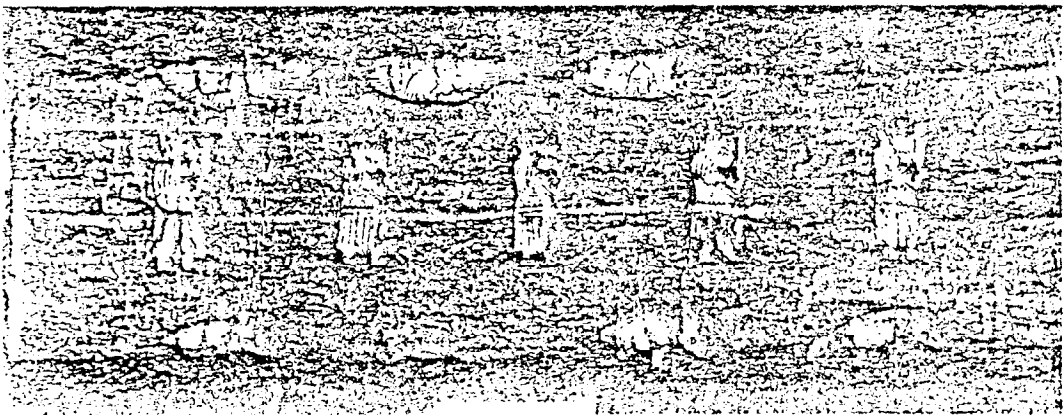

b

Fig. 168.--Kerma: Reconstruction of a Faience Boat and a
Faience Lion

Reisner, Excavations at Kerma: Parts IV-V.

a. Fig. 186

b. fig. 187

c. Fig. 43 The Faience Lion from KII

691

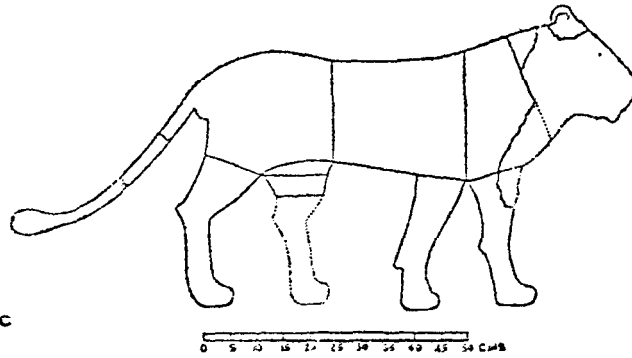
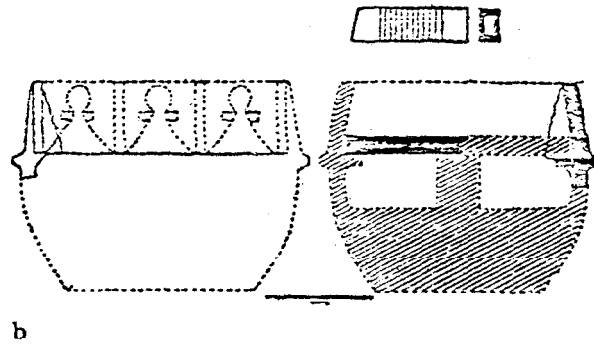
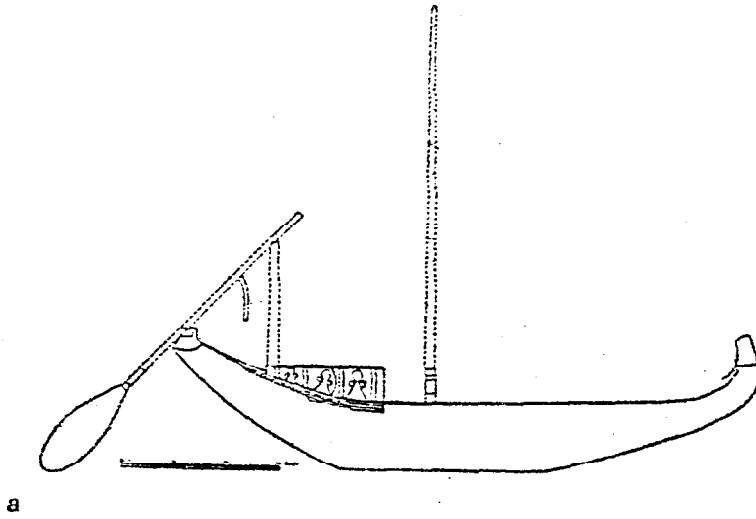

Fig. 169.--Kerma: Faience Vessels of Local Type
Reisner, Excavations at Kerma, Parts IV-V

Figure 182:

- a. 8
- b. 11
- c. 16
- d. 14
- e. 13
- f. 15
- g. 18

Figure 185:

- b. 47

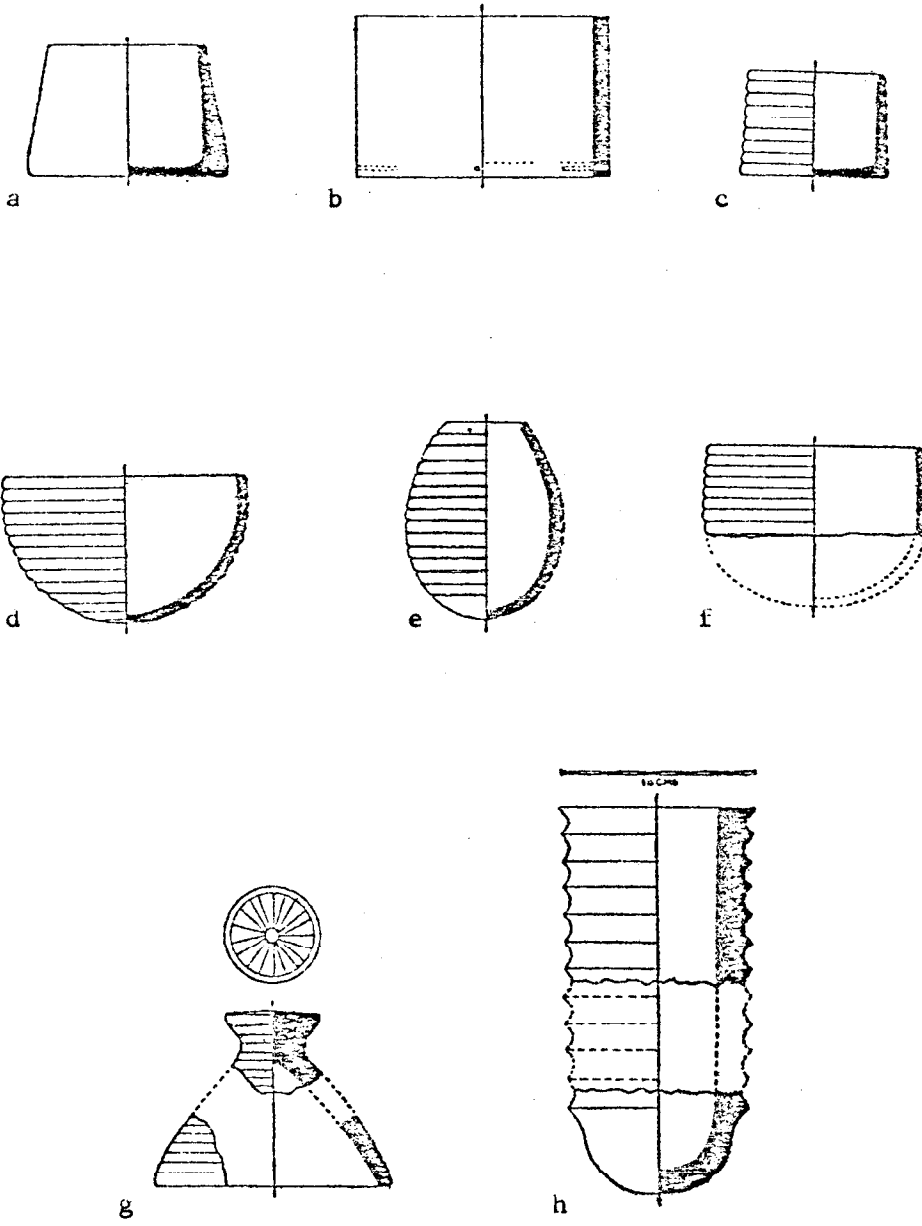

Fig. 170.--Kerma: Faïences Imported (e+f) or of Imported Types

Reisner, Excavations at Kerma, Parts IV-V.

- | | | |
|----|----------|--------|
| a. | Fig. 182 | No. 4 |
| b. | Fig. 182 | No. 5 |
| c. | Fig. 182 | No. 22 |
| d. | Fig. 183 | No. 27 |
| e. | Fig. 183 | No. 31 |
| f. | Fig. 183 | No. 35 |
| g. | Fig. 185 | No. 42 |
| h. | Fig. 185 | No. 46 |
| i. | Fig. 183 | No. 25 |

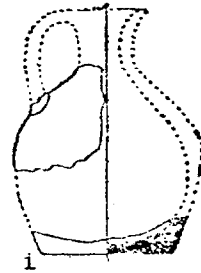
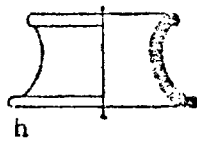
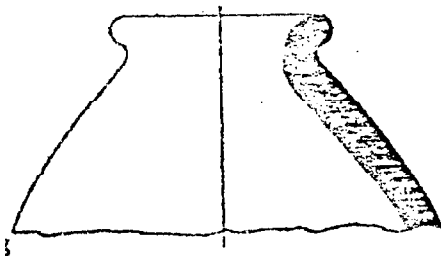
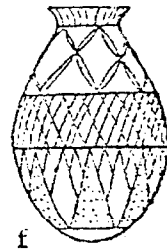
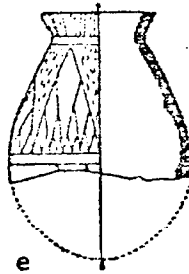
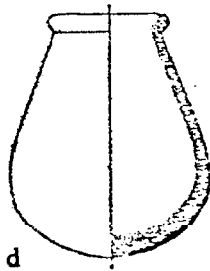
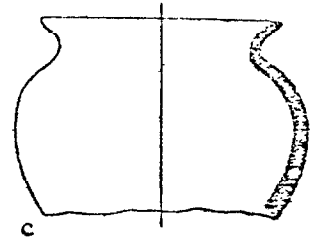
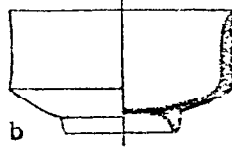
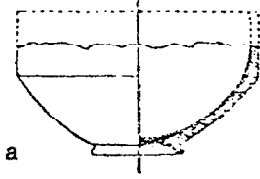
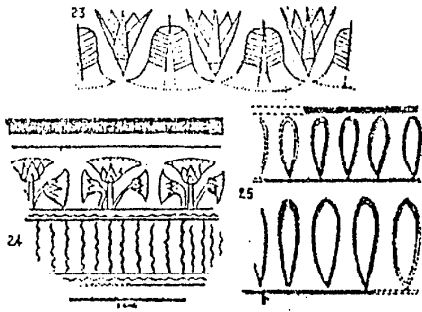

Fig. 171.--Kerma: Patterns of Faience Decoration
Reisner, Excavations at Kerma, Parts IV-V.

a. Fig. 174

b. Fig. 175

c. Fig. 172



a

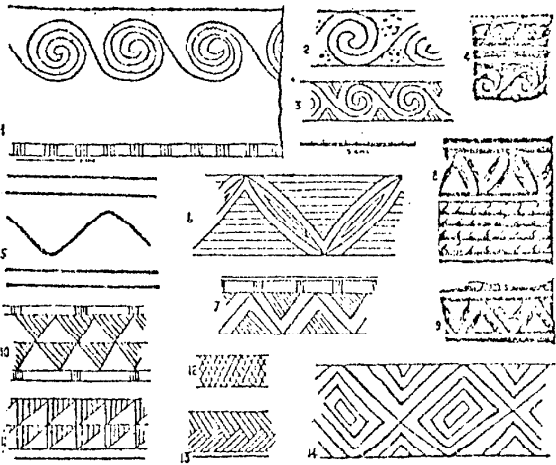

c

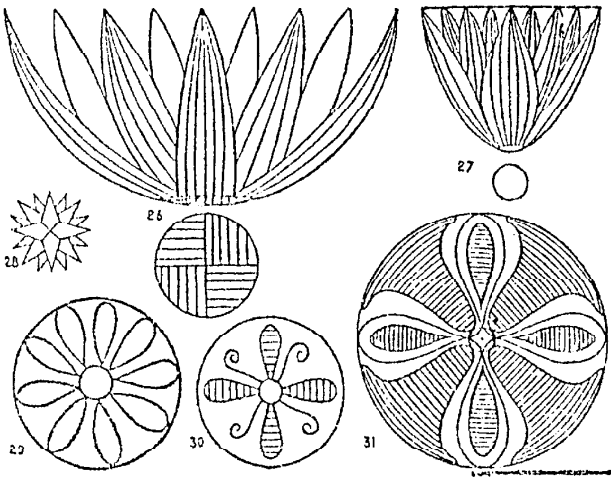

b

Fig. 172.--Kerma: Patterns on Faience Bowls

Reisner, Excavations at Kerma, Parts IV-V.

a. Fig. 178

b. Fig. 177

c. Fig. 176

d. Fig. 173

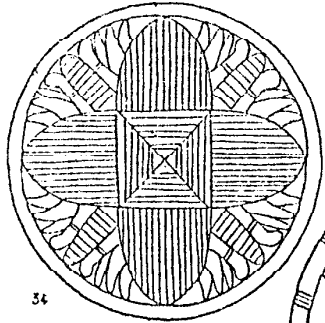

34

a

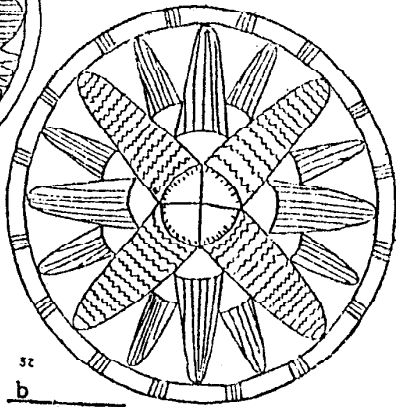

32

b

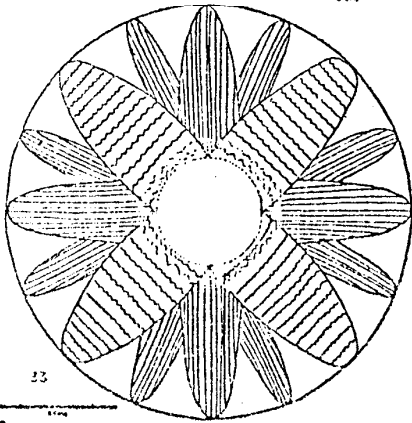

33

c

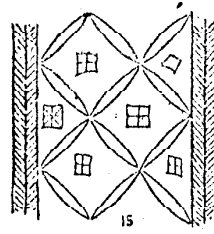

15

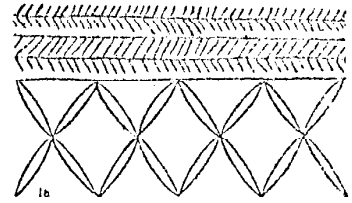

16

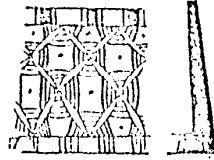

17

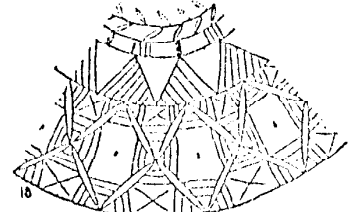

18

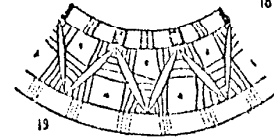

19

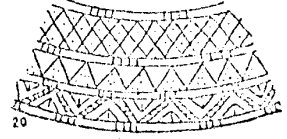

20

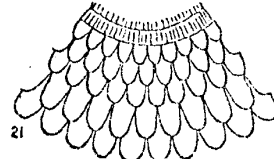

21

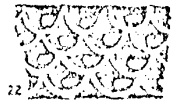

22

d

Fig. 173.--Kerma: Selected Stone Vessels

Reisner, Excavations at Kerma, Parts IV-V.

a. Fig. 166, No. 7

b. Fig. 166, No. 8

c. Fig. 165, No. 1

d. Fig. 165, No. 4

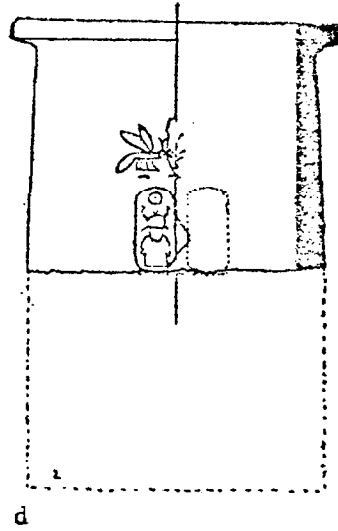
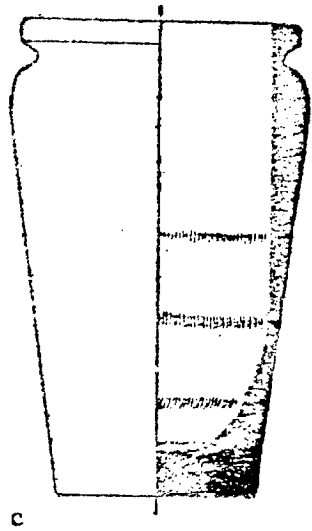
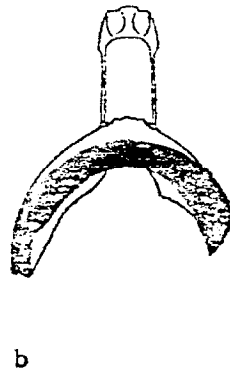
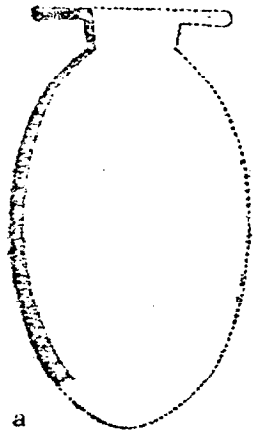

Fig. 174.--Kerma: Selected Stone Vessels, Cylindrical and
Globular Types

Reisner, Excavations at Kerma, Parts IV-V.

- a. Fig. 161, No. 1
- b. Fig. 161, No. 2
- c. Fig. 161, No. 3
- d. Fig. 160, No. 3
- e. Fig. 160, No. 6
- f. Fig. 160, No. 1
- g. Fig. 160, No. 2

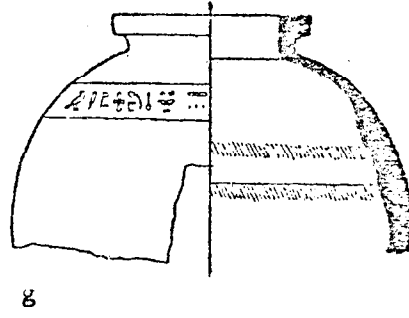
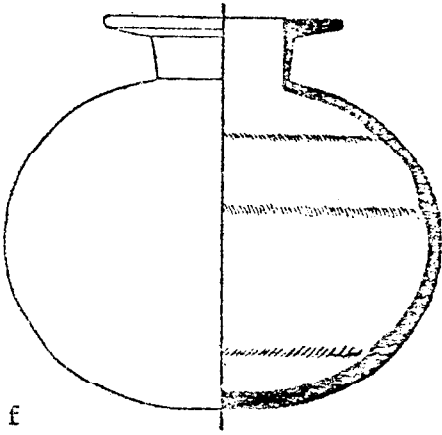
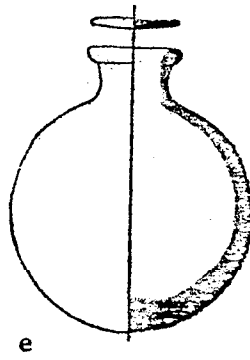
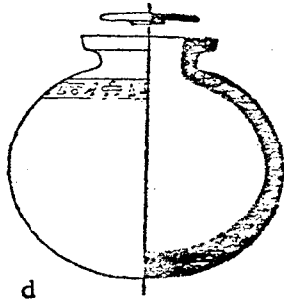
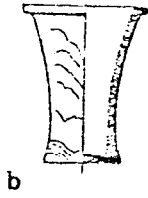

Fig. 175.--Kerma: Selected Stone Vessels

Reisner, Excavations at Kerma, Parts IV-V.

a.	Fig. 163	No. 17	
b.	Fig. 164	No. 34	
c.	Fig. 163	No. 11	
d.	Fig. 164	No. 38	
e.	Fig. 163	No. 13	
f.	Fig. 164	No. 20	
g.	Fig. 164	No. 22	
h.	Fig. 164	No. 23	
i.	Fig. 163	No. 19	
j.	Fig. 164	No. 24	
k.	Fig. 164	No. 29	
l.	Fig. 163	No. 1	
m.	Fig. 163	No. 3	
n.	Fig. 163	No. 5	
o.	Fig. 163	No. 6	
p.	Fig. 163	No. 10A	
q.	Fig. 159	No. 2	
r.	Fig. 159	No. 3	
s.	Fig. 159	No. 6	
t.	Fig. 159	No. 9	Mayor of El Kab--Sebeknakhe

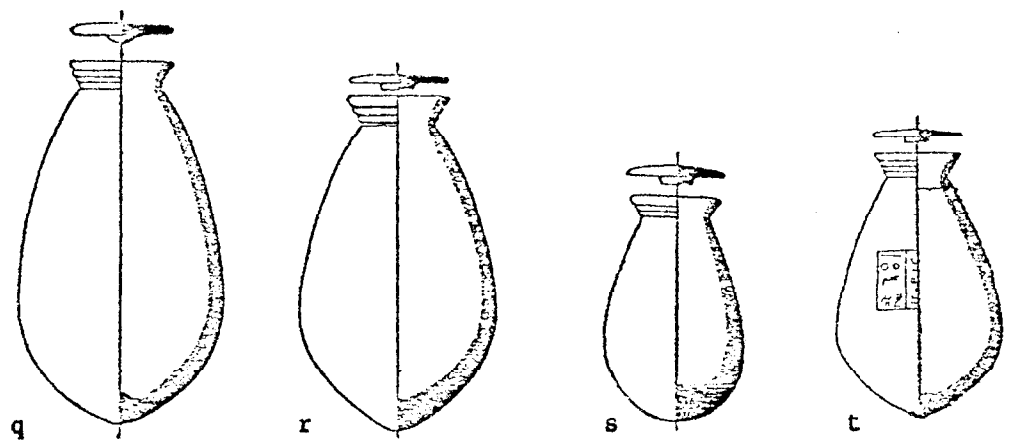
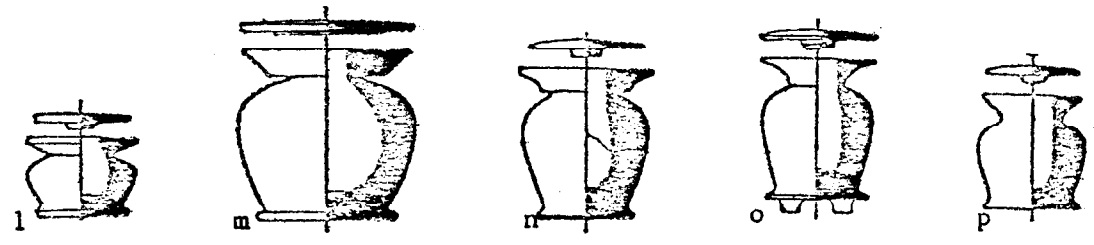
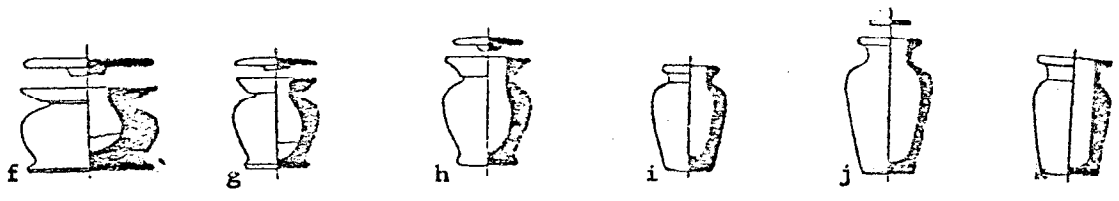
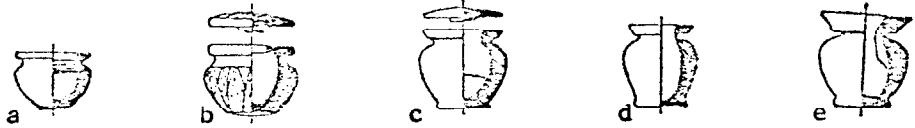
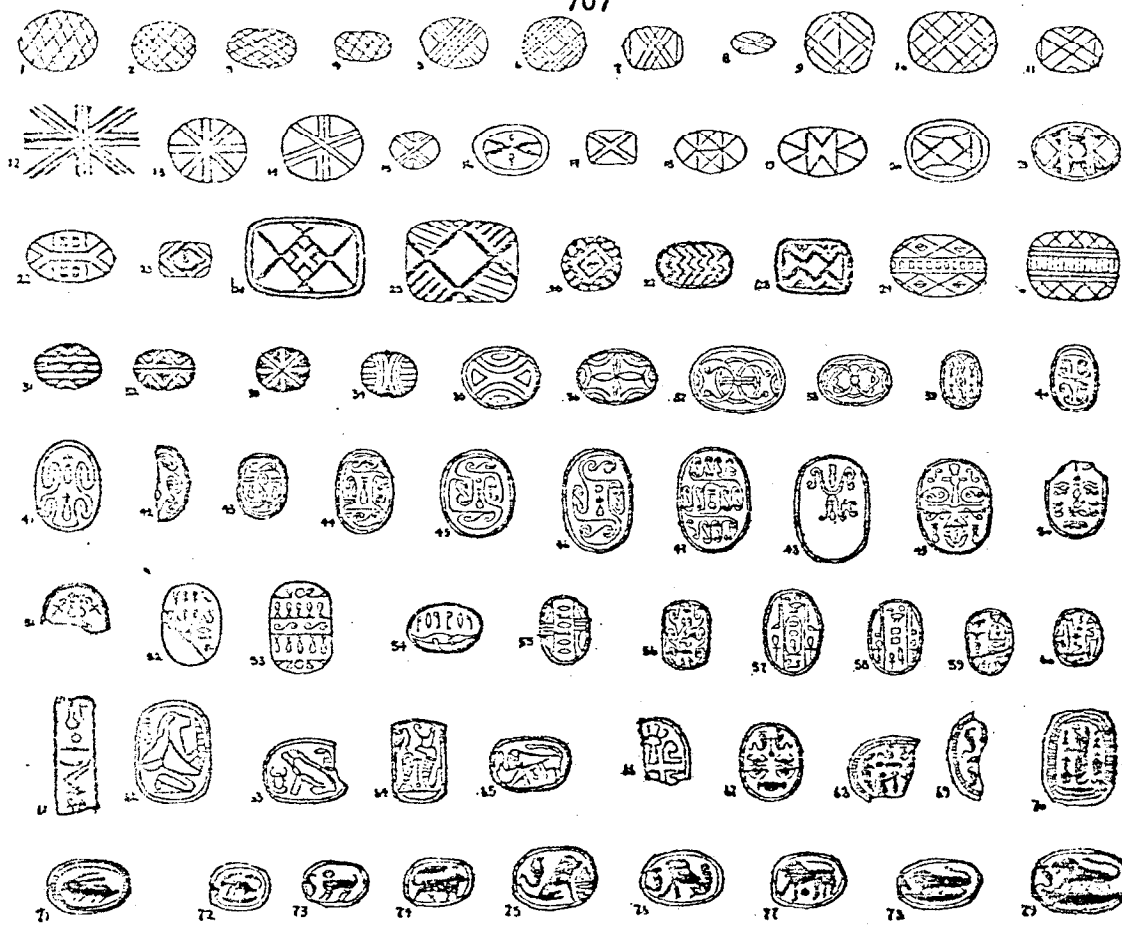

Fig. 176.--Kerma: Seal Impressions

Reisner, Excavations at Kerma, Parts IV-V.

a. Fig. 163

b. Fig. 169



a

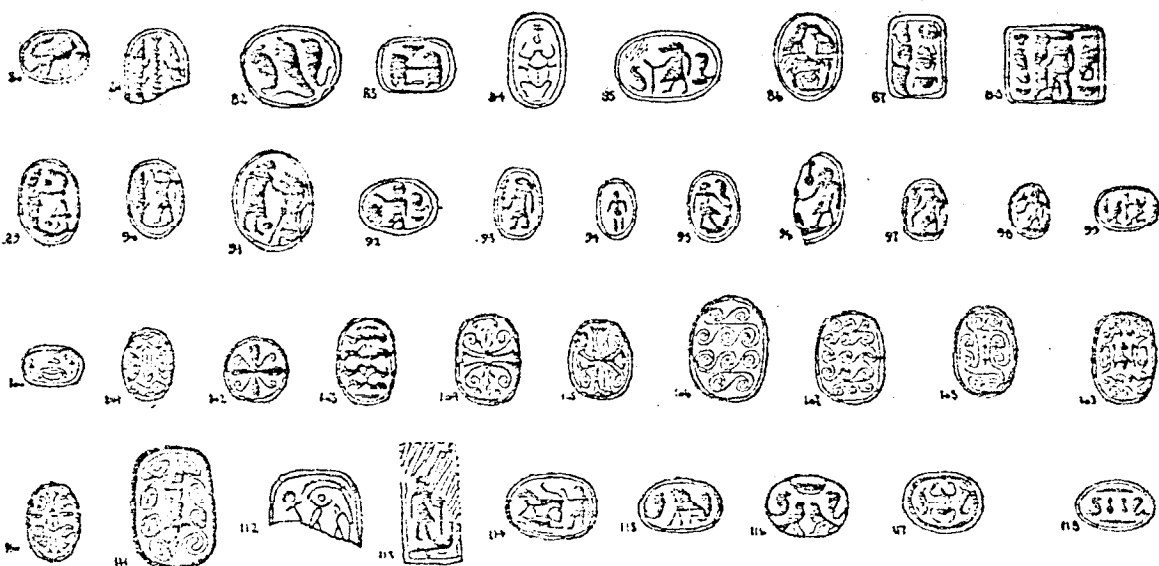

b

Fig. 177.--Kerma: Imported Juglets

Reisner, Excavations at Kerma, Parts IV-V.

a. RP	Fig. 281	From KIV
b. RP	Fig. 281	From KIV
c. Black incised (WJ)	Fig. 264	From KK
d. Black incised (WJ)	Fig. 264	From KK
e. Black incised (WJ)	Fig. 264	From KXVI
f. RP Grey	Fig. 316	From KXVI

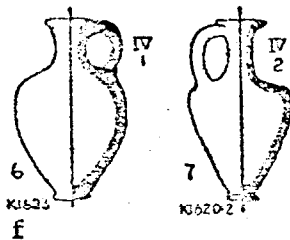
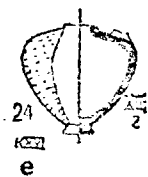
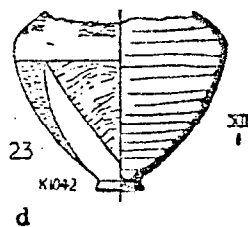
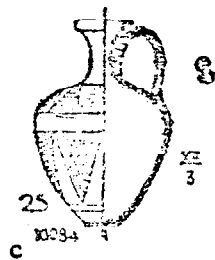
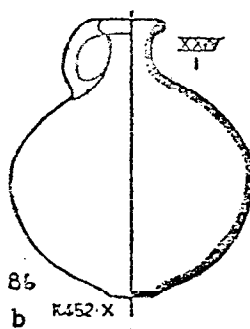
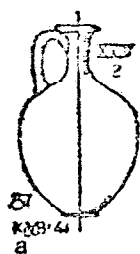

Fig. 178.--Kerma: BKT II from K III
Reisner, Excavations at Kerma, Parts IV-V, Fig. 227.

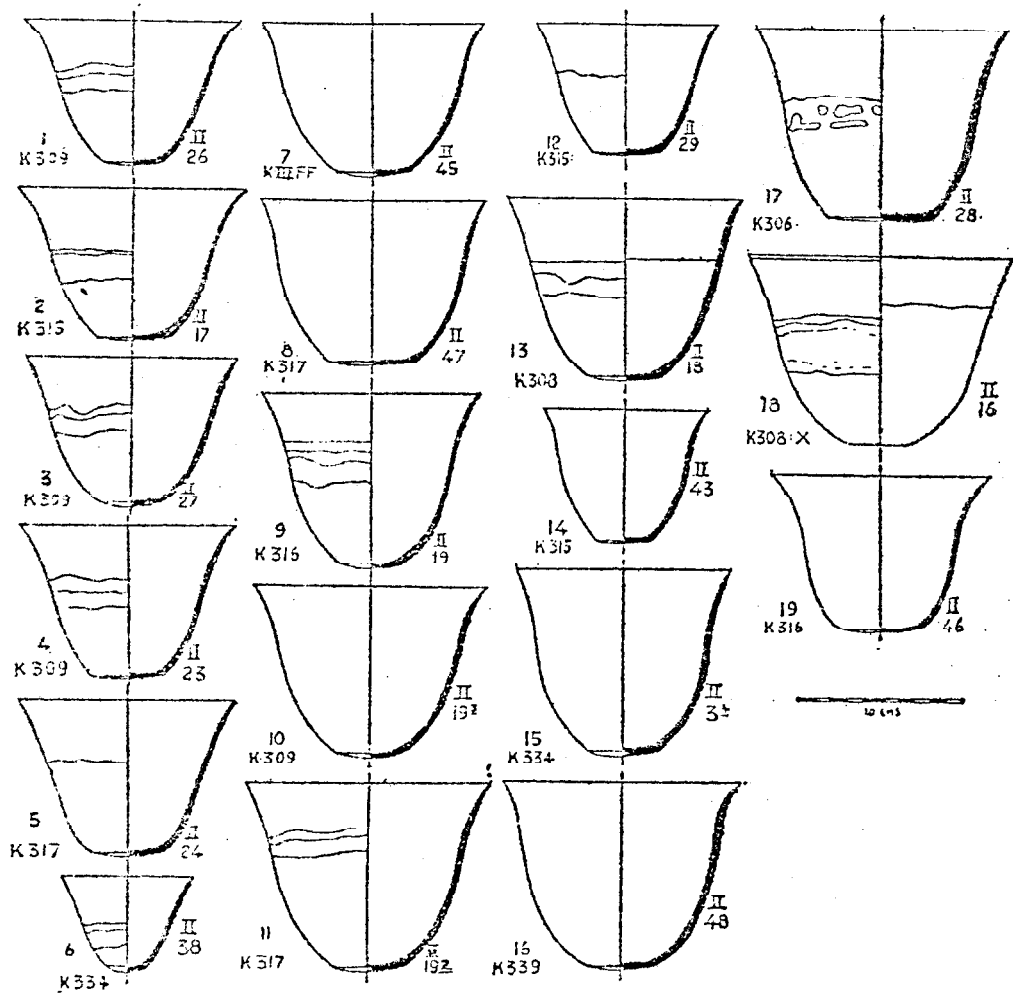

Fig. 179.--Kerma: Pottery from K III BKT

Reisner, Excavations at Kerma, Parts IV-V.

- a. BKT XII, 1-3 Fig. 237
- b. BKT X, 1-7 Fig. 236
- c. BKT I, 1-9 Fig. 226
- d. BKT III, 1-5 Fig. 230

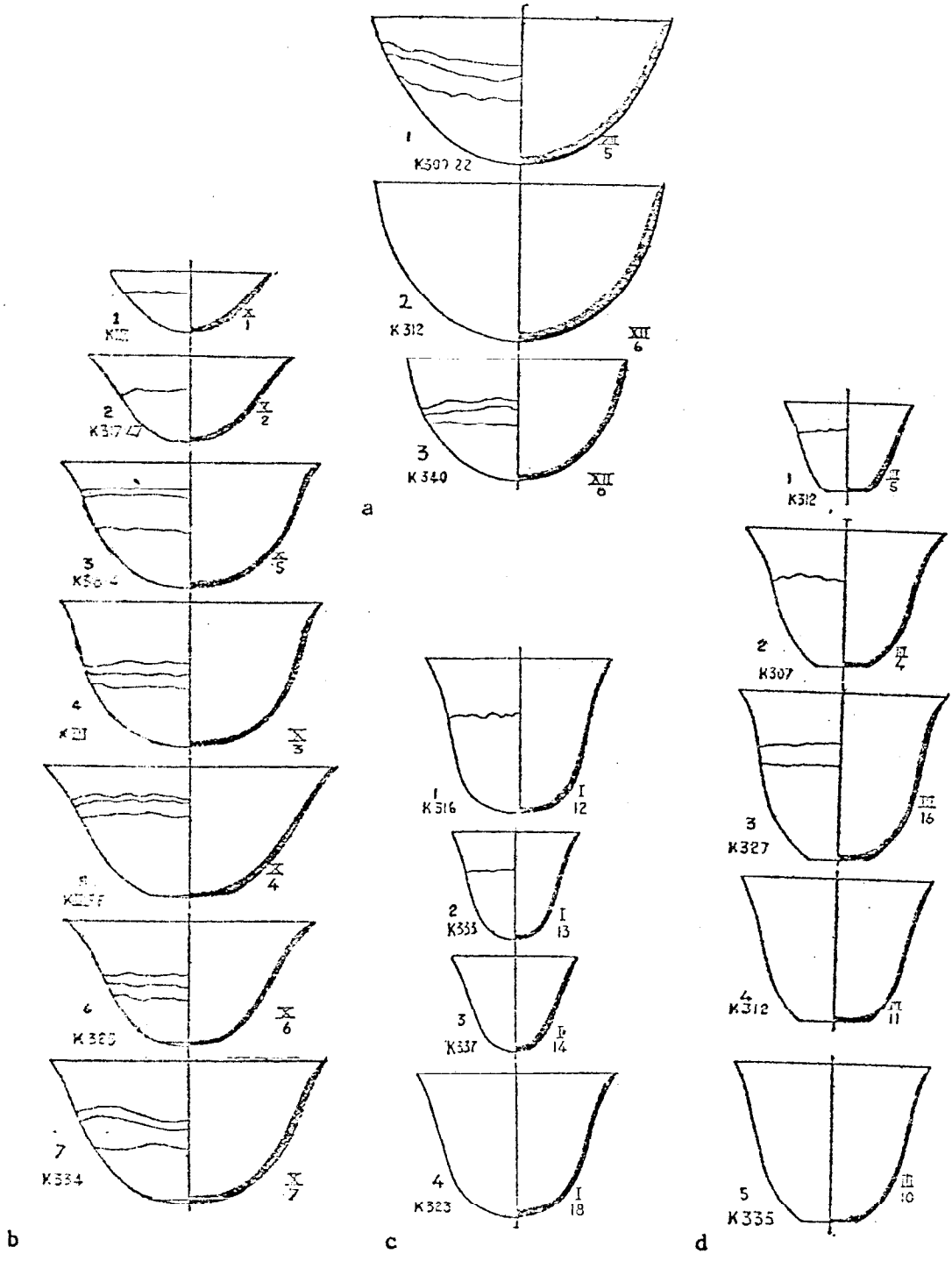
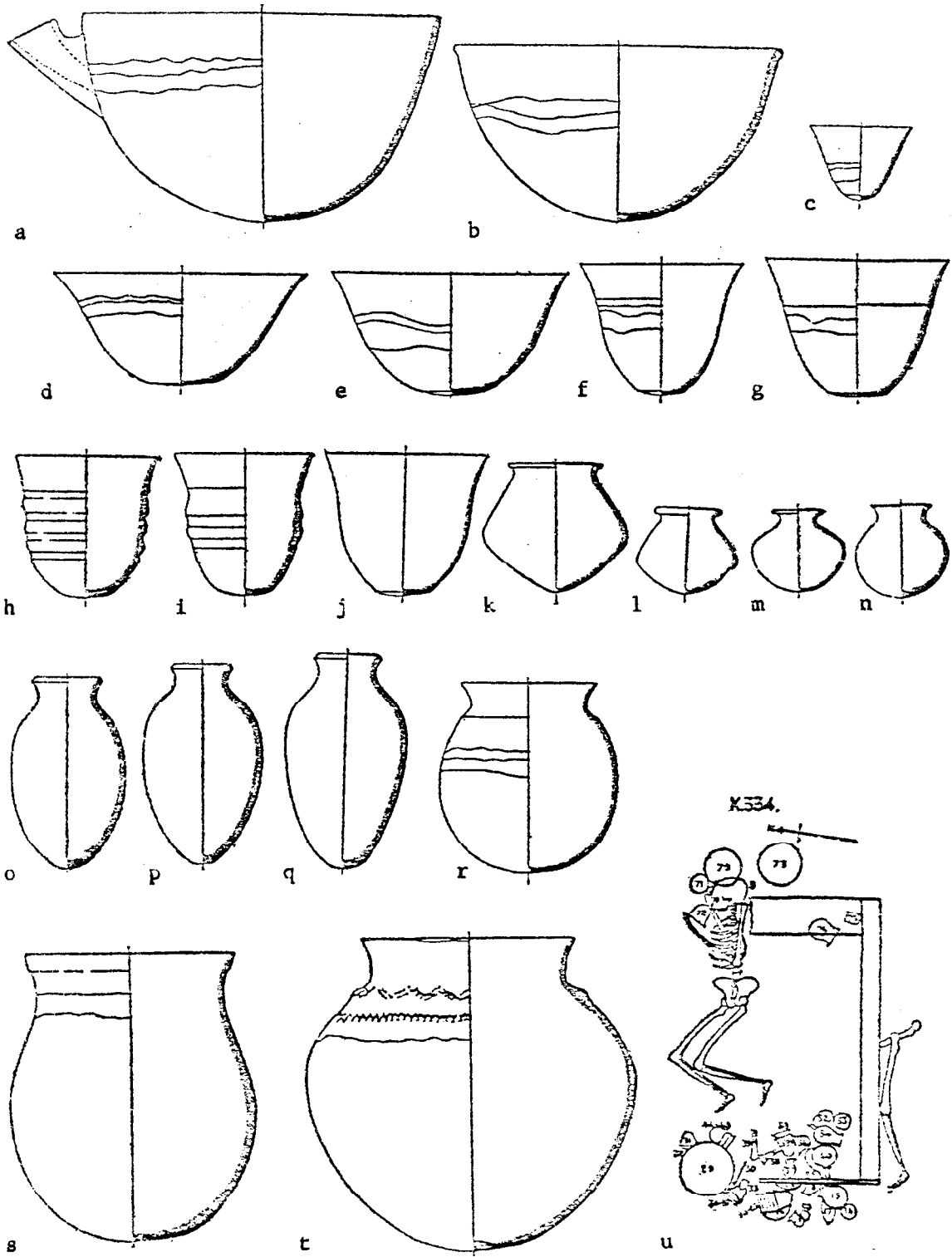

Fig. 181.--Kerma: Pottery from K334

Reisner, Excavations at Kerma, Parts IV-V.

a.	Fig.	9	BKT XIV	No. 9
b.		4	XIV	11
c.		6	II	38
d.		5	X	4
e.		7	X	7
f.		9	II	19
g.		13	II	18
h.		92	XXVIII	1
i.		24	X	5
j.		15	II	3
k.		11	VI	1
l.		40	VI	3
m.		33	V	2
n.		34	V	3
o.		8	VI	3
p.		7	VI	2
q.		65	XIV	1
r.		2	XVII	19
s.		5	XVI	3
t.		2	XVII	22
u.		47		



· Fig. 182.--Kerma: BKT II from K IV
Reisner, Excavations at Kerma; Parts IV-V, fig. 228.

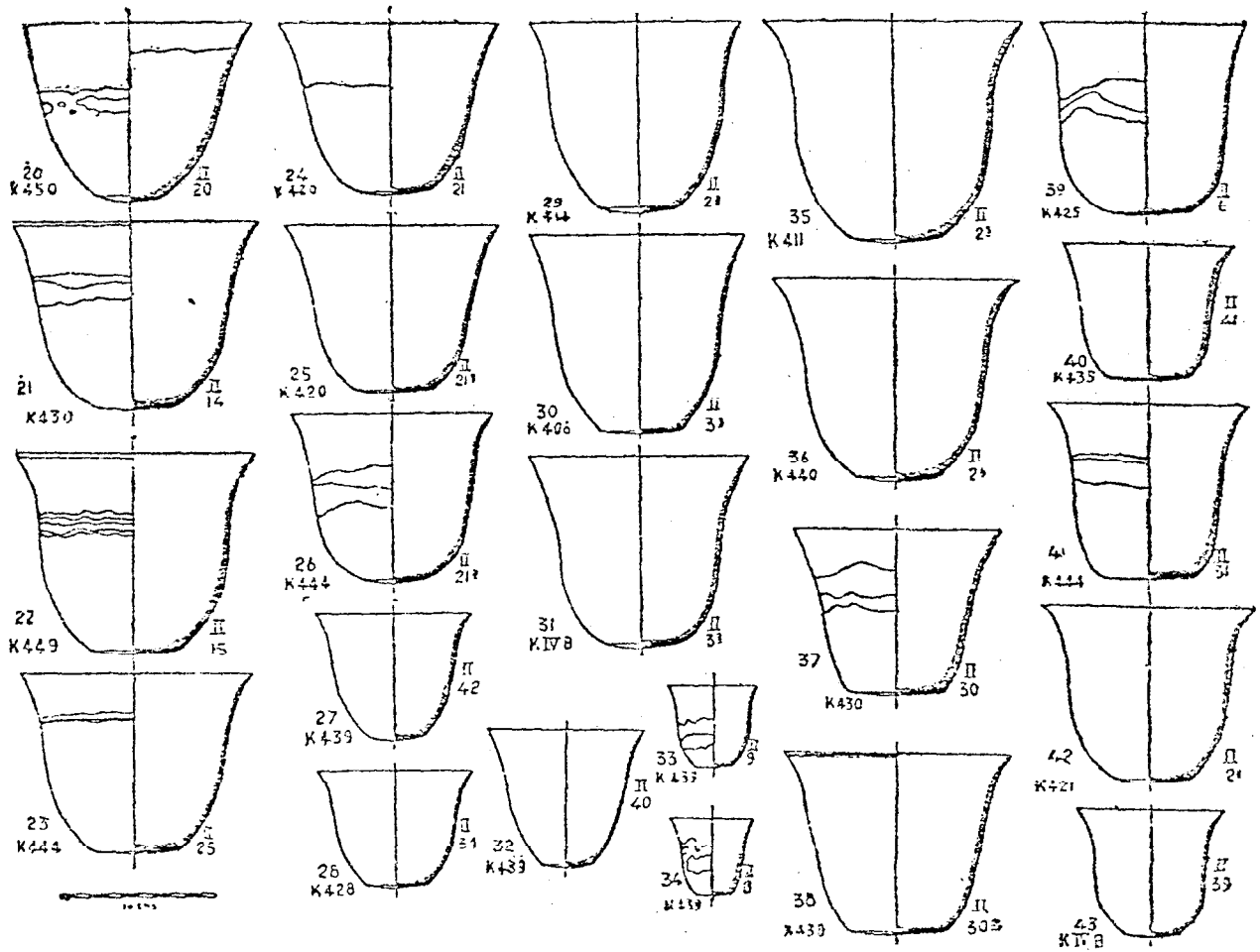

Fig. 183.--Kerma: Pottery from K IV

Reisner, Excavations at Kerma, Parts IV-V.

- a. BKT IV, 1-3, 5 Fig. 231
- b. BKT X and XI, 1 and 2 Fig. 236
- c. BKT III, 6-10 Fig. 230
- d. BKT XII, 4-8 Fig. 237
- e. BKT I, 5-11 Fig. 226

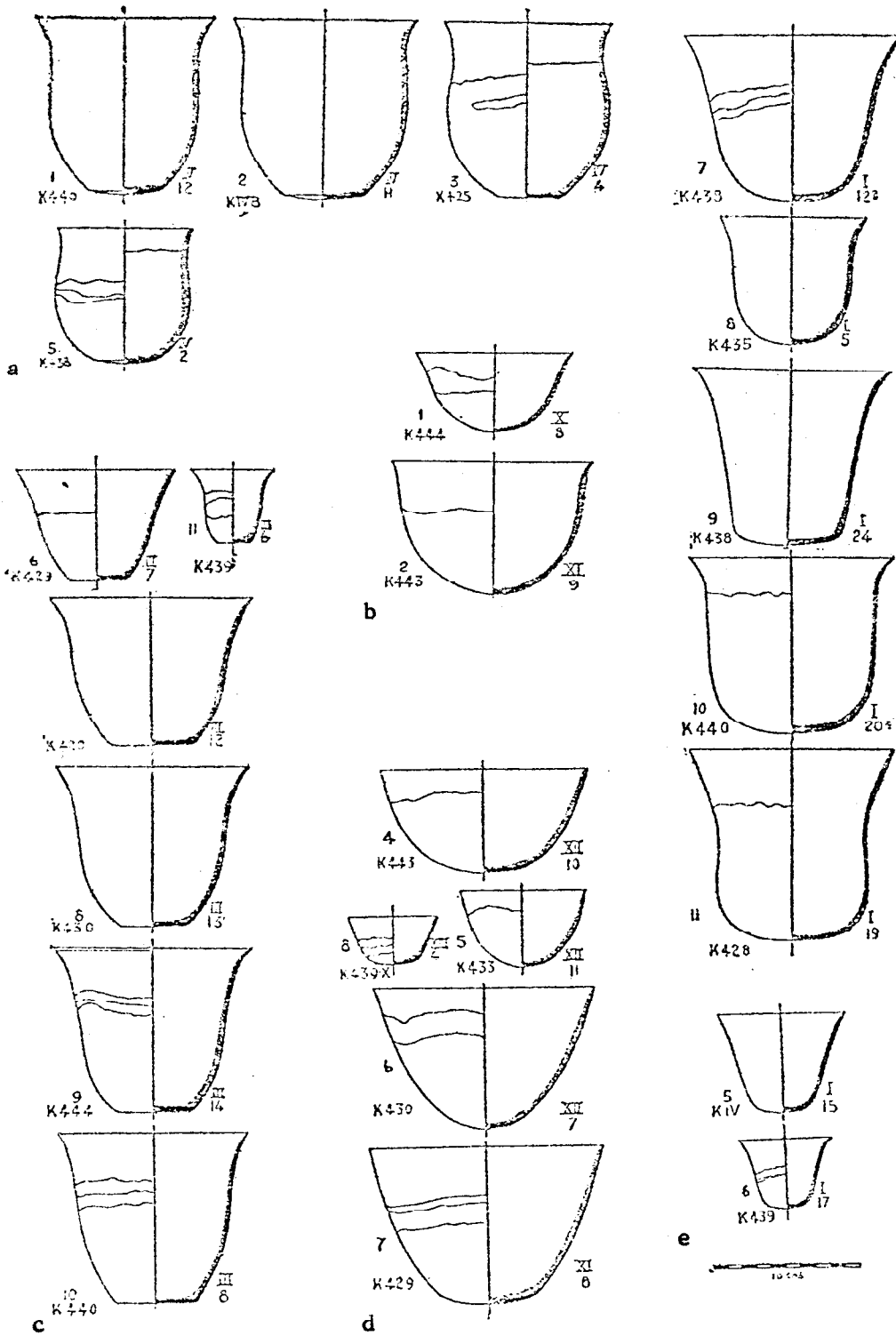

Fig. 184.--Kerma: Pottery from K IV (Cont.)

Reisner, Excavations at Kerma, Parts IV-V.

- a. BKT XIV, 11, 12 Fig. 239
- b. BKT IV, 11 Fig. 231
- c. BKT XVII, 7, 8 Fig. 243

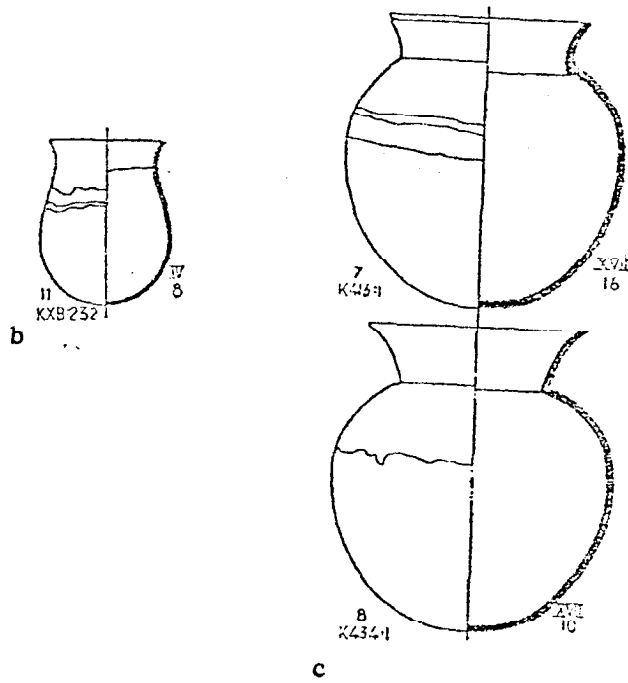
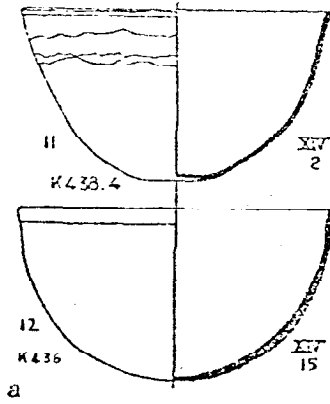

Fig. 185.--Kerma: Pottery of BKIII from K X (62 is from KXXXIX)

Reisner, Excavations at Kerma, Parts IV-V, Fig. 228

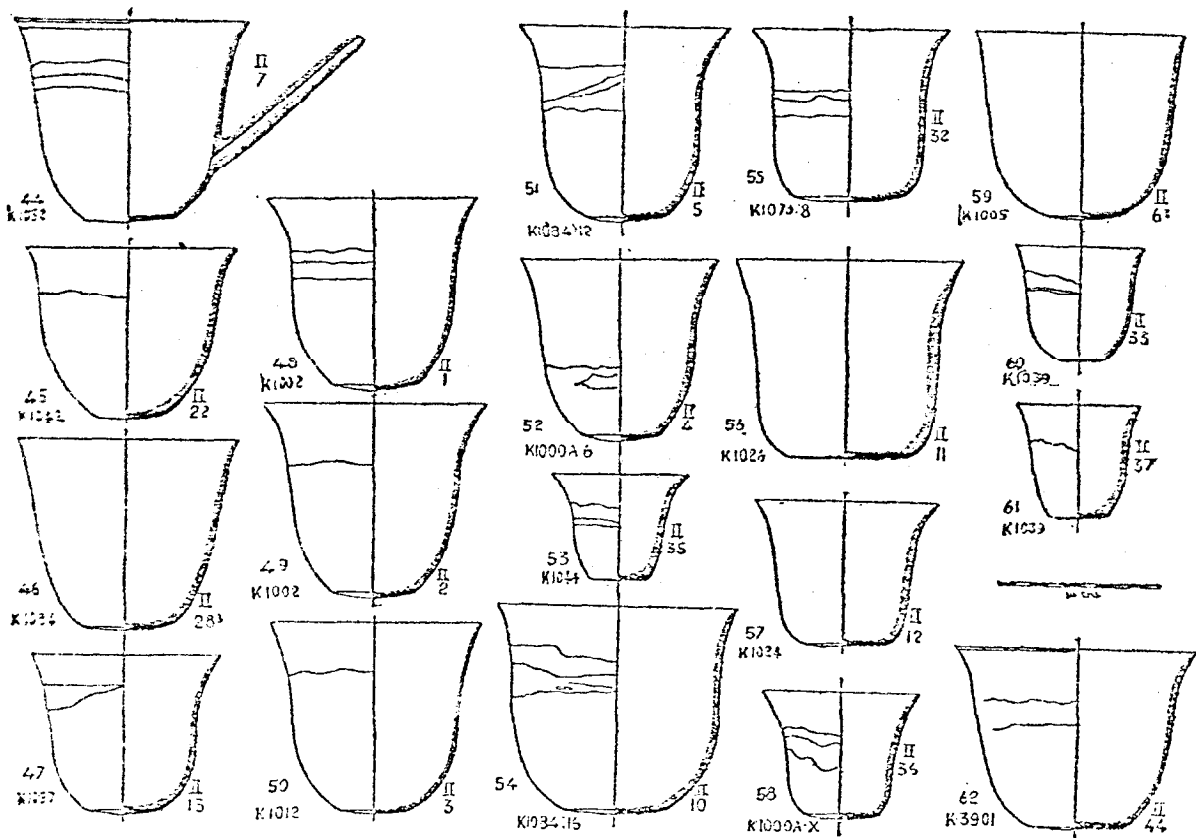
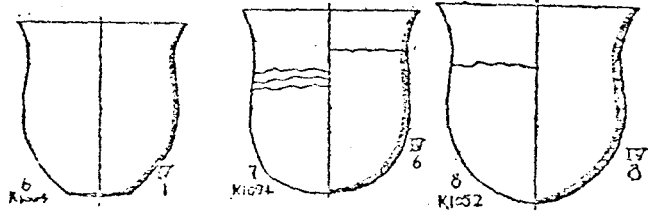

Fig. 186.--Kerma: BKT Pottery from K X

Reisner, Excavations at Kerma, Parts IV-V.

a.	BKT IV	Fig. 231	6-8
b.	BKT IV	Fig. 231	4
c.	BKT I	Fig. 226	12-22, 26, 27
d.	BKT III	Fig.	1, 2, 15, 9, 3
e.	BKT XII	Fig. 237	9, 10, 11-13
f.	BKT XI	Fig. 236	3-6



a

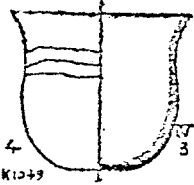

b

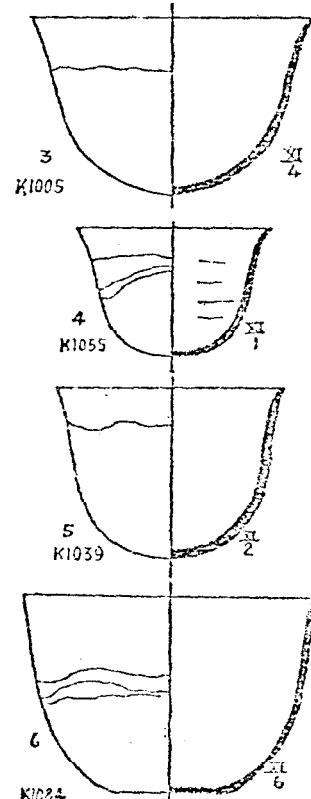
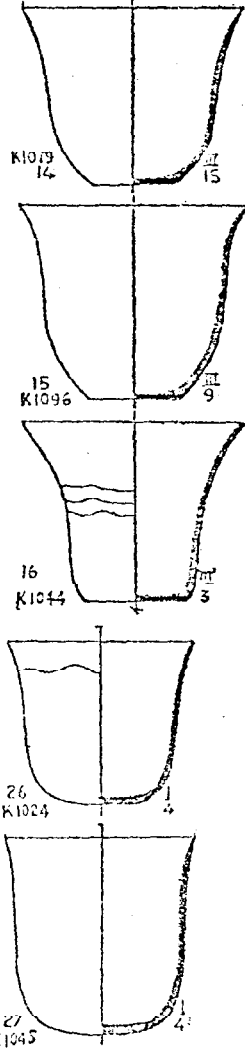
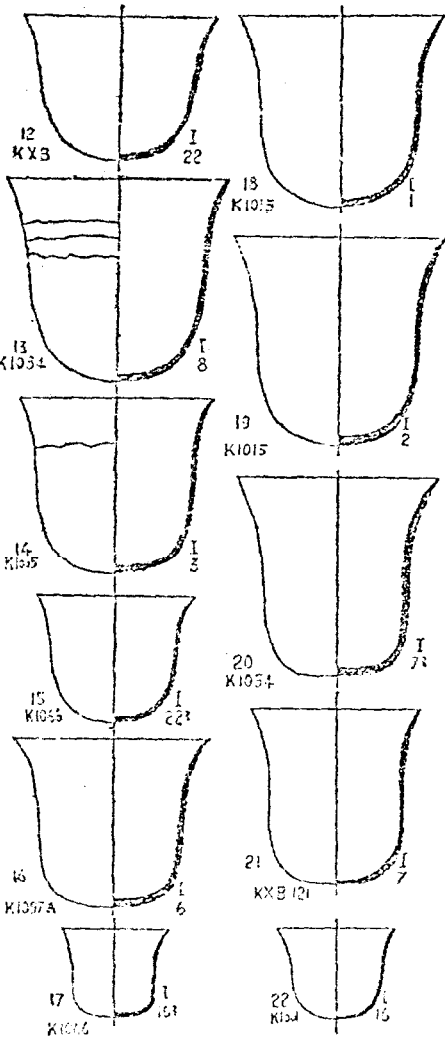
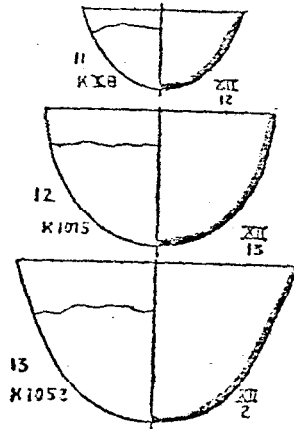
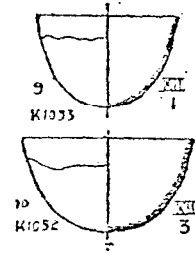
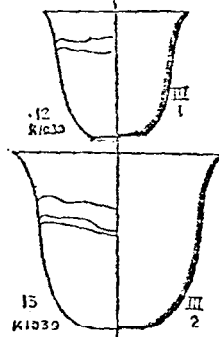

f

Fig. 187.--Kerma: Selected Pottery from K 429 and K X

Reisner, Excavations at Kerma, Parts IV-V, Fig. 232. 2-13.

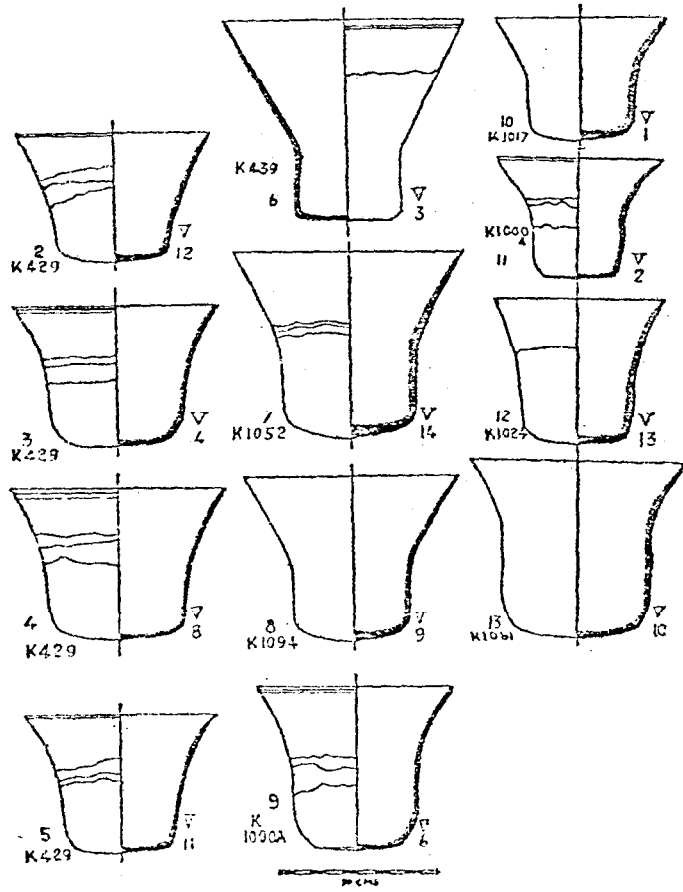
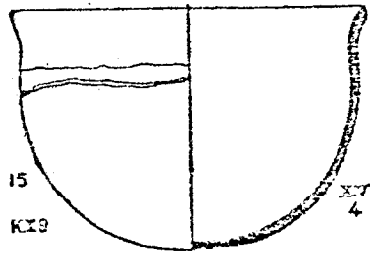
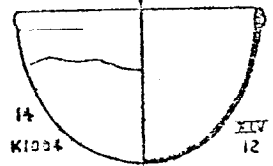
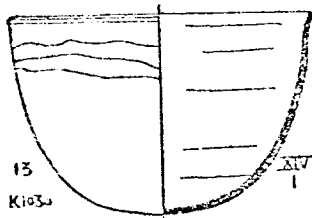

Fig. 188.--Kerma: Pottery from K X

Reisner, Excavations at Kerma, Parts IV-V.

a.	BKT XIV	Fig. 239	13-15
b.	BKT XVIII	Fig. 244	2
c.	BKT XVII	Fig. 243	12
d.	BKT XVII	Fig. 243	14, 15



a

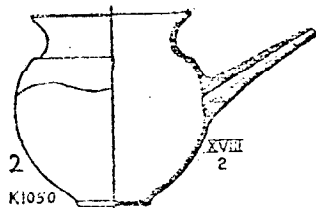

b

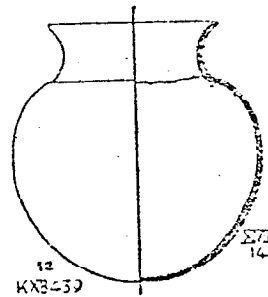

c

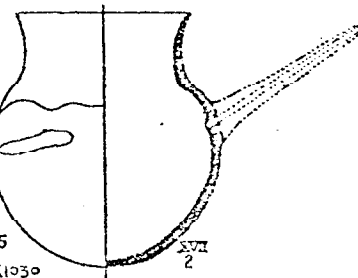
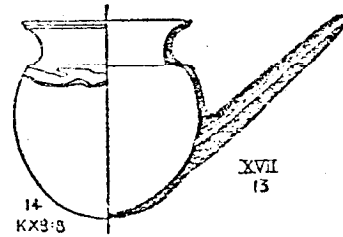

d

XX

Fig. 189.--Kerma: Pottery of BKT VIII from KXVI, XVIII, XIX and

Reisner, Excavations at Kerma, Parts IV-V, Fig. 235.

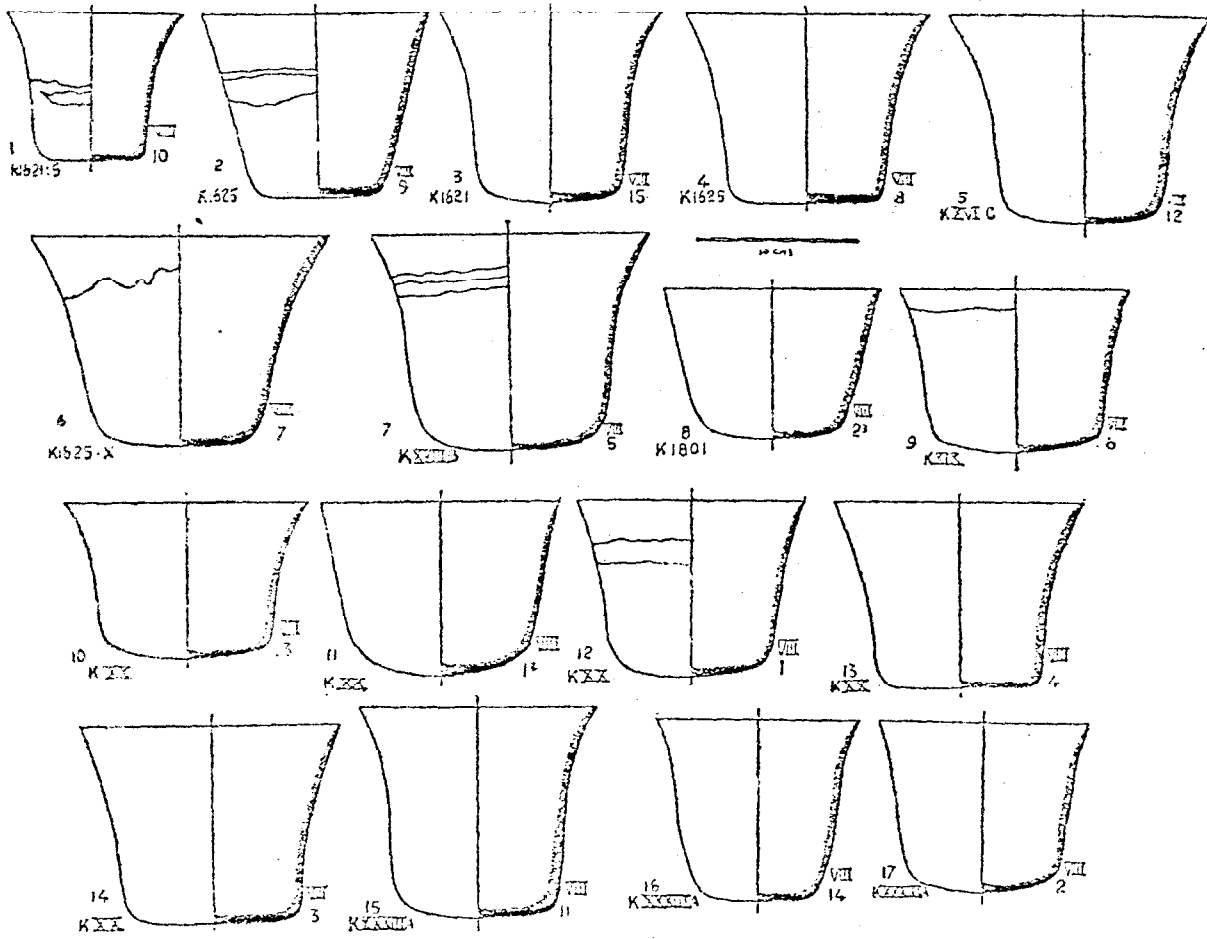
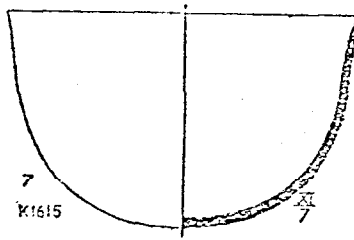

Fig. 190.--Kerma: BKT XI and I from K XVI

Reisner, Excavations at Kerma, Parts IV-V.

a. BKT XI Fig. 236

b. BKT I Fig. 226



a

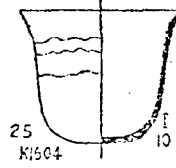
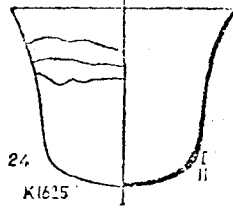
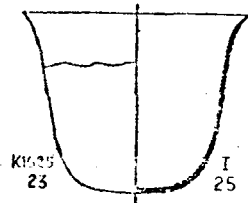

b

Fig. 191.--Kerma: C-Group Influence

Reisner, Excavations at Kerma, Parts IV-V.

a. White-filled Incised Ware Fig. 263

b. White-Filled Incised Ware Fig. 264

NOTE: 1-17 provenienced as subscript lower left.

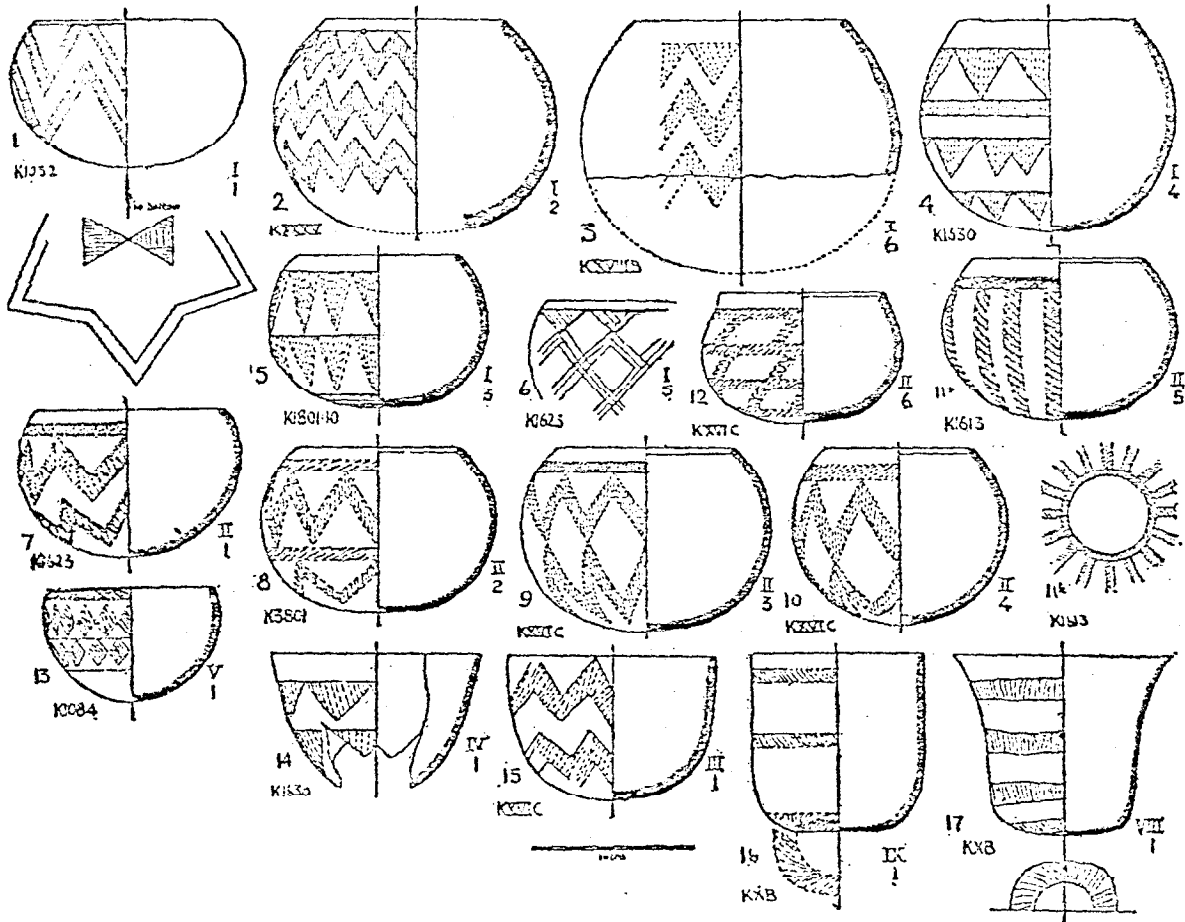

a

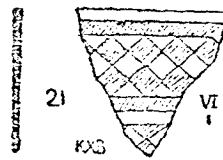
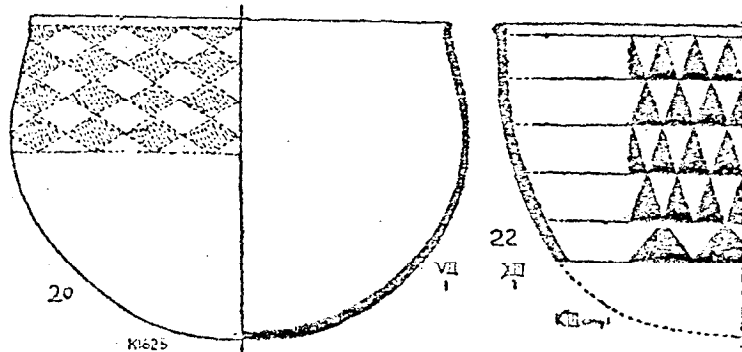

b

Fig. 192.--Kerma: The Beaker Stack, Black Polished (BP)

Reisner, Excavations at Kerma, Parts IV-V, Fig 260 (Provenience as subscript).

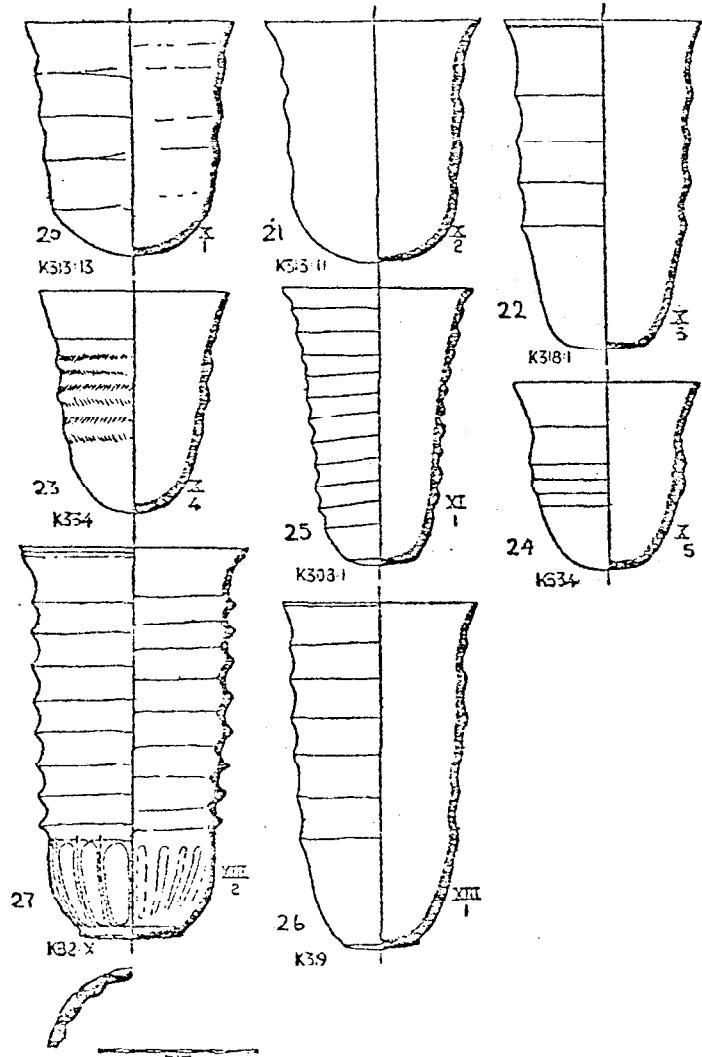

Fig. 193.--Kerma: the Kerma Teapot
Reisner, Excavations at Kerma, Parts IV-V.

- a. Red Polished Fig. 283
- b. Red Polished Fig. 283
- c. Red Polished Fig. 283
- d. Red Polished Fig. 284

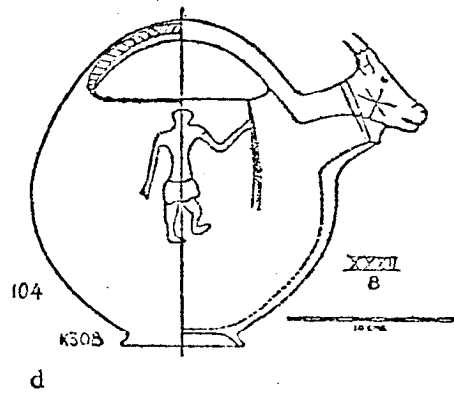
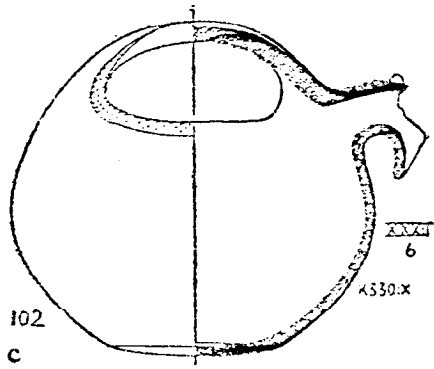
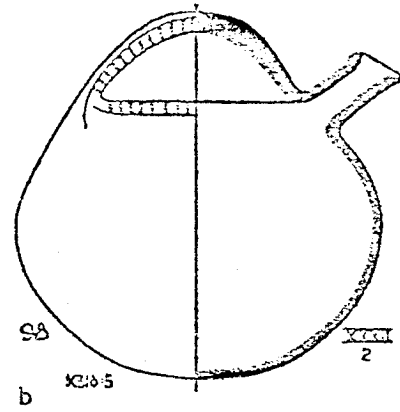
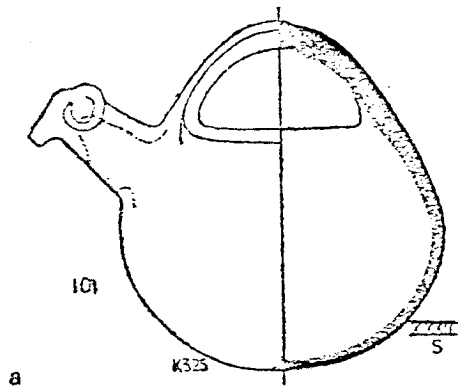

Fig. 194.--Kerma: The Kerma Lid

Reisner, Excavations at Kerma, Parts IV-V.

- | | | |
|----|--------------------|----------|
| a. | Black Incised (WJ) | Fig. 263 |
| b. | Black Incised (WJ) | Fig. 263 |
| c. | Black Polished | Fig. 261 |
| d. | Black Polished | Fig. 261 |
| e. | Black Polished | Fig. 261 |
| f. | Black Polished | Fig. 261 |
| g. | Black Polished | Fig. 261 |
| h. | Red Polished | Fig. 282 |
| i. | Red Polished | Fig. 282 |

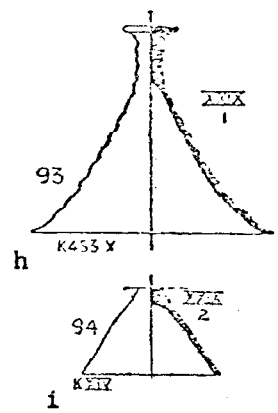
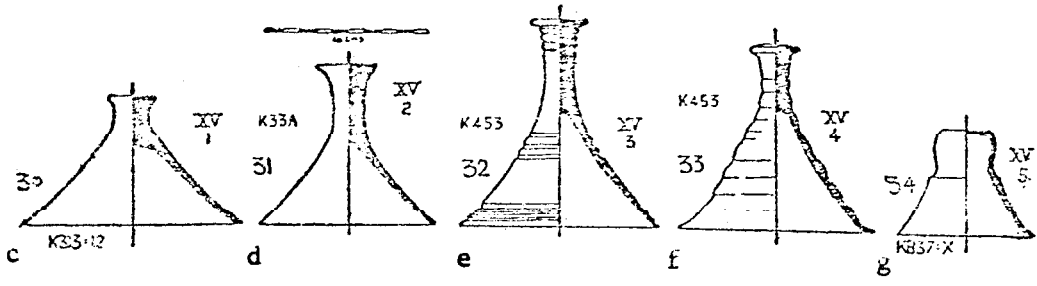
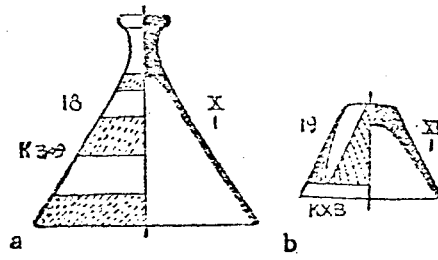

Fig. 195.--Kerma: Black Ware

Reisner, Excavations at Kerma, Parts IV-V, Fig. 324.

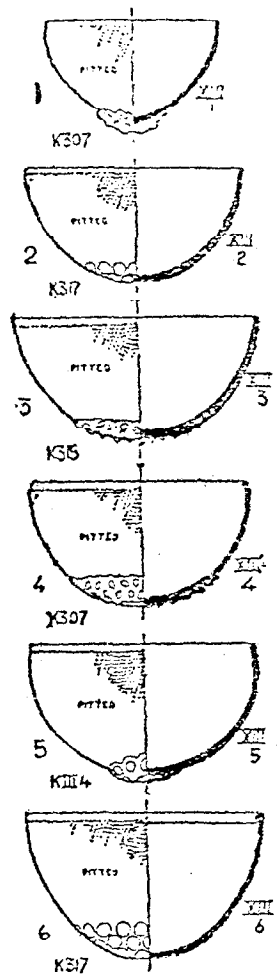

Fig. 196.--Kerma: Egyptianizing Wares from K III

Reisner, Excavations at Kerma, Parts IV-V.

a.	RW	Fig. 298
b.	RP	Fig. 281
c.	RP	Fig. 271
d.	RP	Fig. 270
e.	RP	Fig. 271
f.	KW	Fig. 318
g.	Db W	Fig. 310
h.	WSR	Fig. 302
i.	BP	Fig. 258
j.	BB	Fig. 258
k.	RP	Fig. 272
l.	RP	Fig. 272
m.	RP	Fig. 272
n.	BP	Fig. 256
o.	BP	Fig. 256
p.	RP	Fig. 272
q.	RP	Fig. 272
r.	BP	Fig. 256
s.	BP	Fig. 258
t.	BP	Fig. 256
u.	BP	Fig. 258
v.	RP	Fig. 272

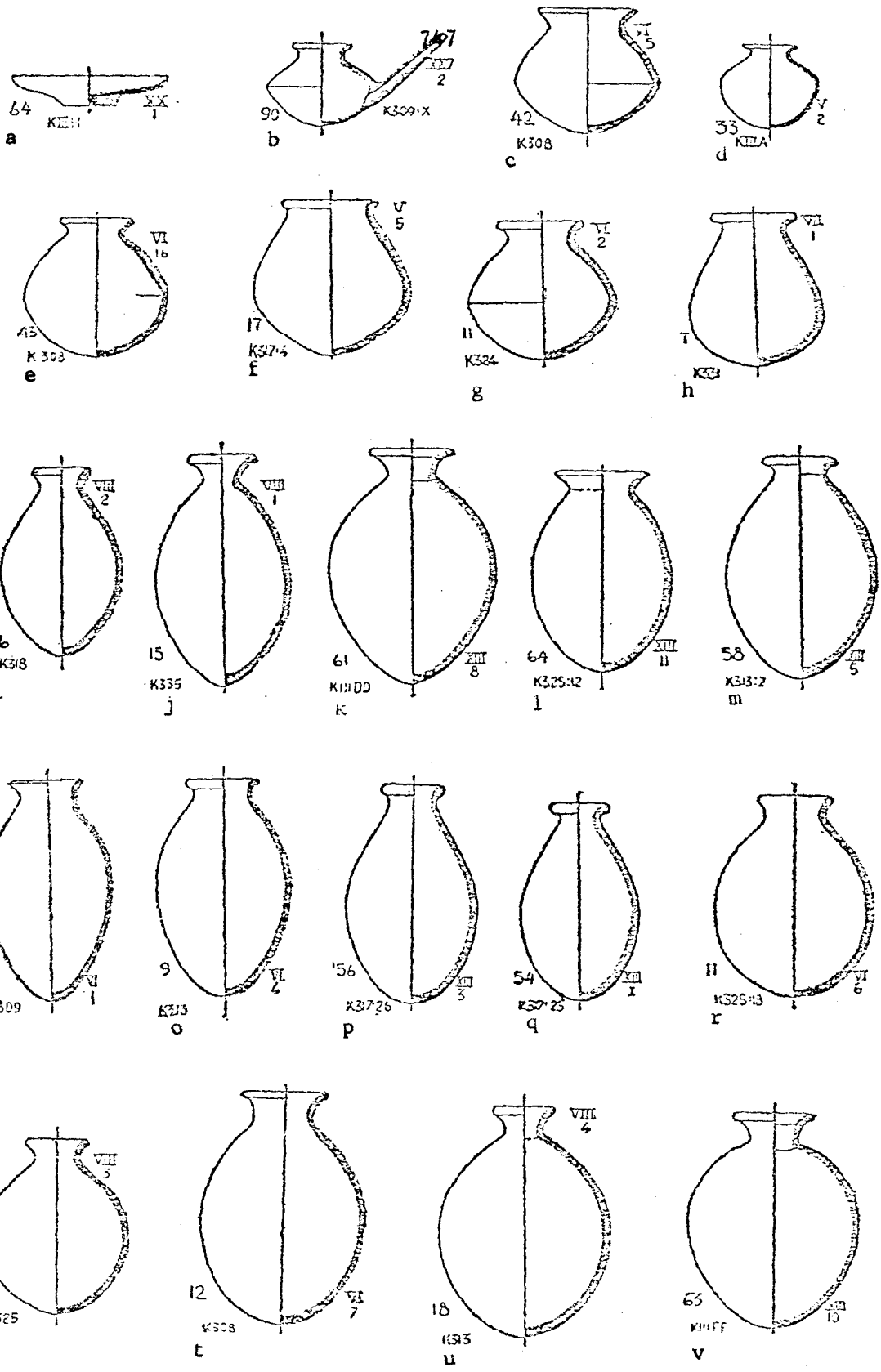
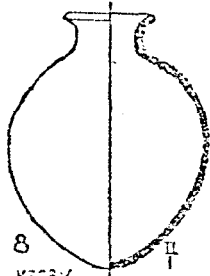

Fig. 197.--Kerma: Egyptianizing Wares from K III (Cont.)

Reisner, Excavations at Kerma, Parts IV-V.

a.	RP	Fig. 266
b.	RP	Fig. 255
c.	RP	Fig. 271
d.	RP	Fig. 271
e.	RP	Fig. 271
f.	W P Grey	Fig. 315
g.	RP	Fig. 271
h.	PWSR	Fig. 309
i.	RP	Fig. 278
j.	WSR	Fig. 305
k.	RW	Fig. 320
l.	WSR	Fig. 303
m.	KW	Fig. 319
n.	KW	Fig. 319



a

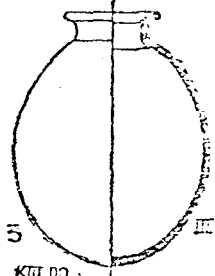

b

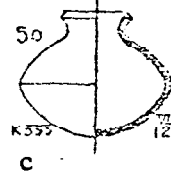

c

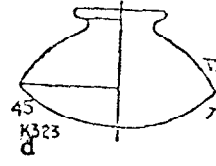

d

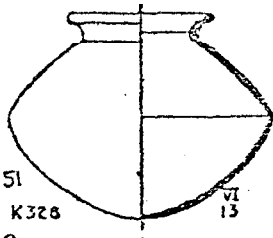

e

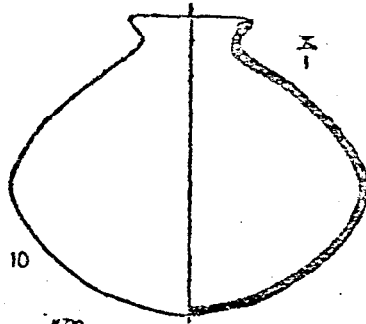

f

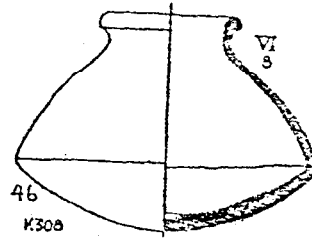

g

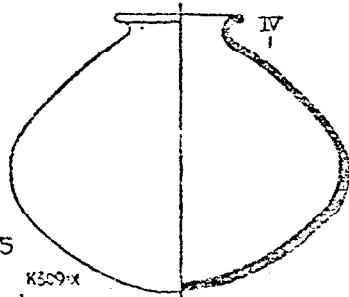

h

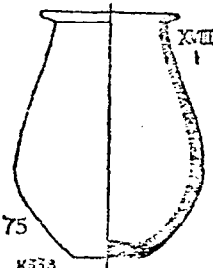

i

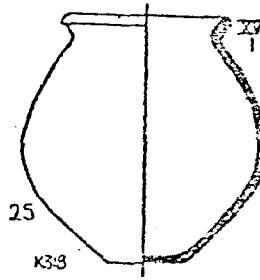

j

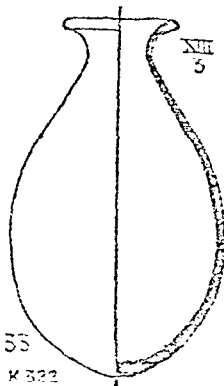

k

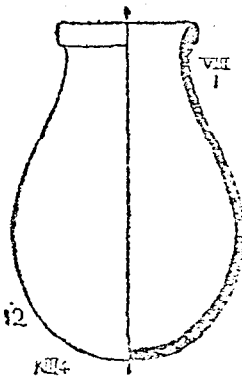

l

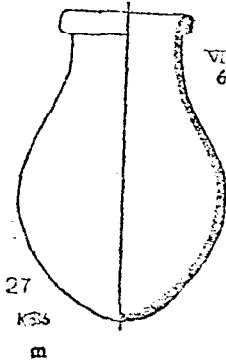

m

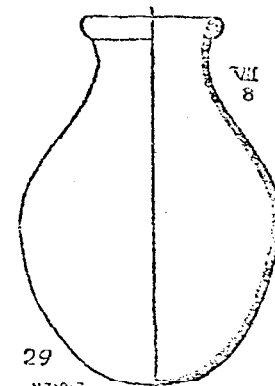

n

Fig. 198.--Kerma: Egyptianizing Wares of K III (Cont.)

Reisner, Excavations at Kerma, Parts IV-V.

- a. RP Fig. 267
- b. RP Fig. 266
- c. RP Fig. 268
- d. RW Fig. 291
- e. WSR Fig. 306
- f. RP Fig. 274
- g. RP Fig. 274

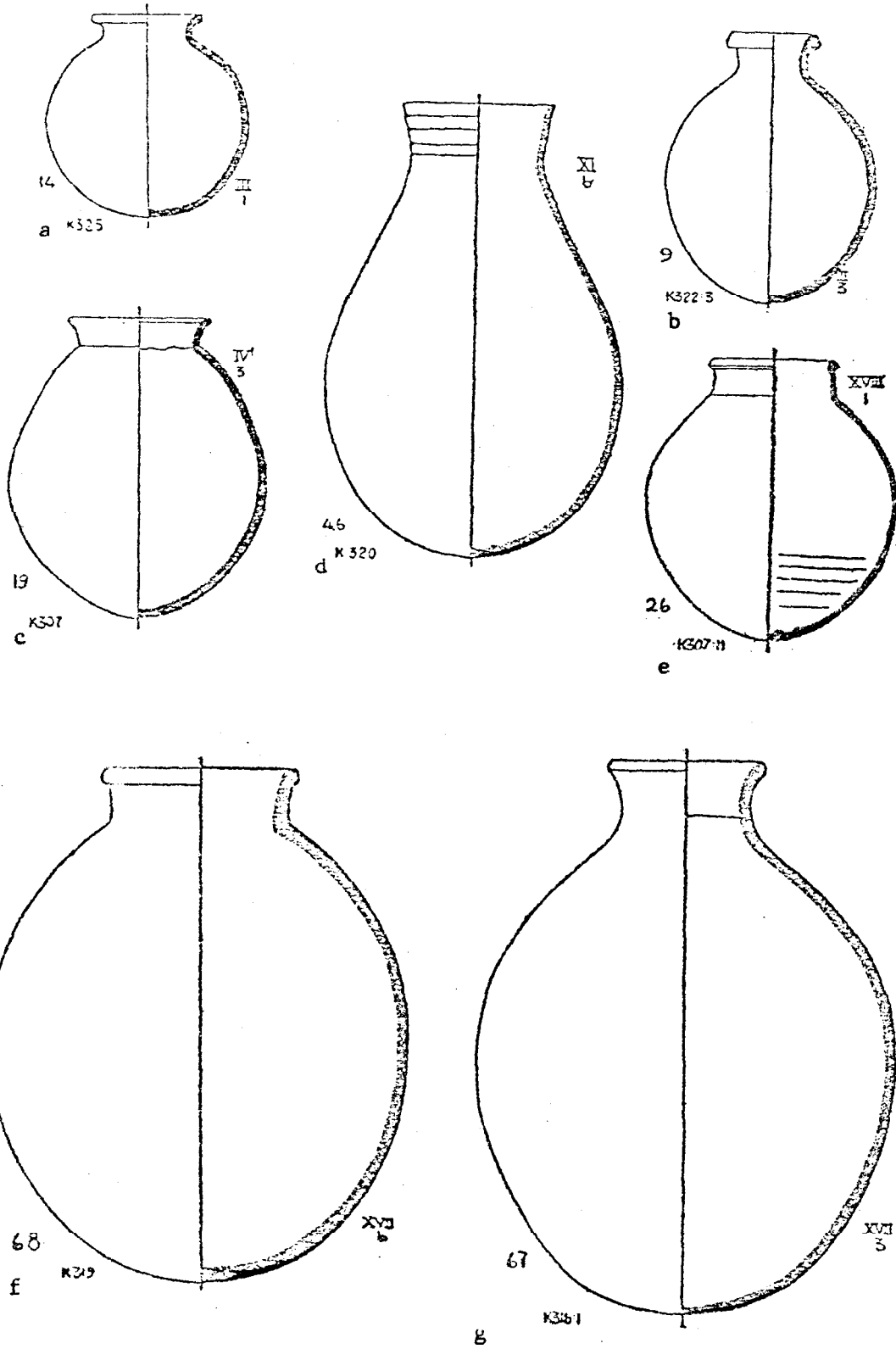

Fig. 199. Kerma: Painted Pottery from K III

Reisner, Excavations at Kerma, Parts IV-V.

a. Fig. 341

b. Fig. 340

c. Fig. 340

d. Fig. 340

e. Fig. 340

f. Fig. 340

g. Fig. 340

h. Fig. 340

i. Fig. 340

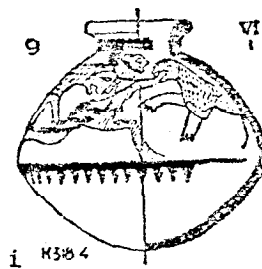
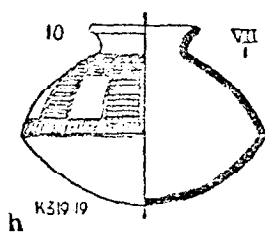
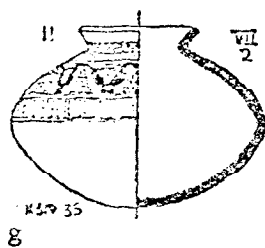
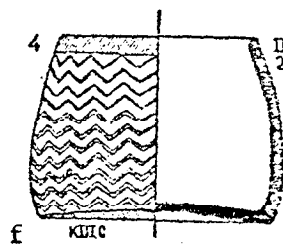
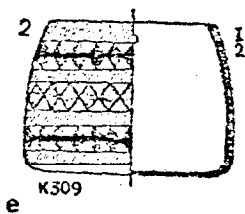
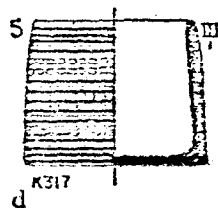
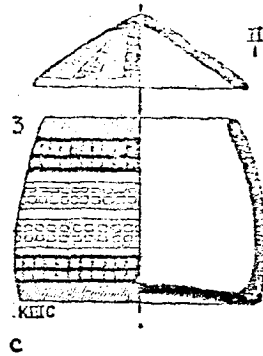
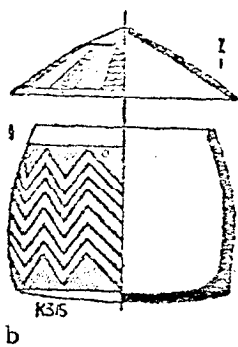
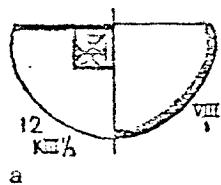

Fig. 200.--Kerma: Egyptianizing Wares from K IV

Reisner, Excavations at Kerma, Parts IV-V.

a.	RW	Fig. 286
b.	WSR	Fig. 302
c.	RW	Fig. 286
d.	RW	Fig. 286
e.	KW	Fig. 317
f.	RW	Fig. 286
g.	RP	Fig. 270
h.	RP	Fig. 270
i.	Db W	Fig. 309
j.	F Db W	Fig. 313
k.	BP	Fig. 255
l.	F Db W	Fig. 313
m.	W P Grey	Fig. 315
n.	RP	Fig. 271
o.	RP	Fig. 271
p.	R P Grey	Fig. 316
q.	R P Grey	Fig. 316
r.	R P Grey	Fig. 316
s.	RP	Fig. 271
t.	RP	Fig. 316
u.	KW	Fig. 317

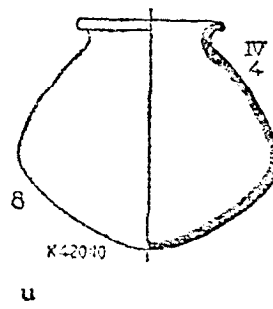
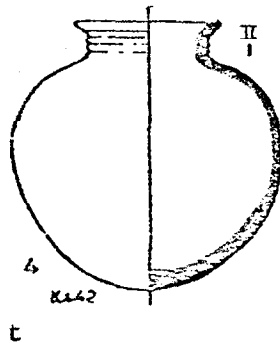
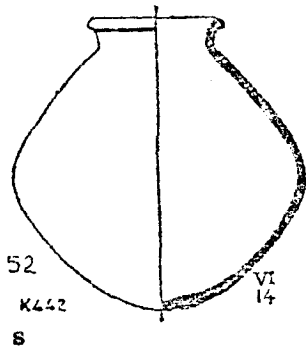
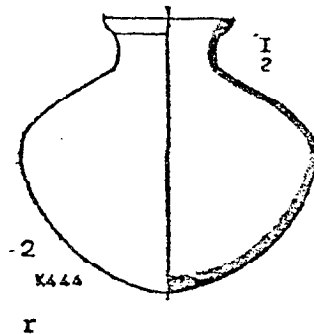
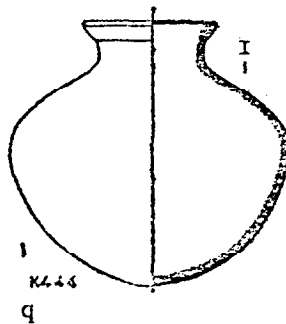
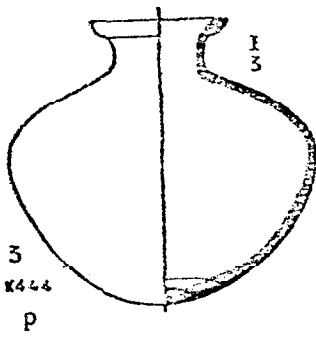
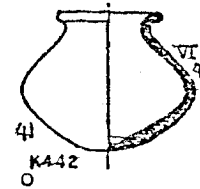
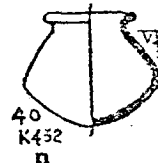
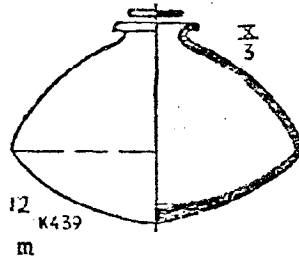
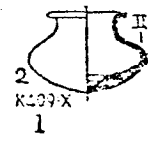
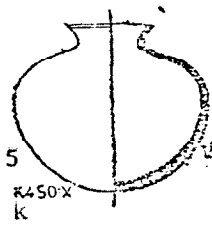
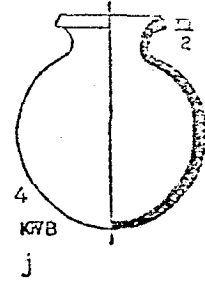
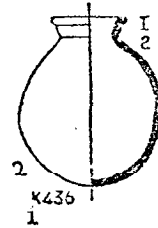
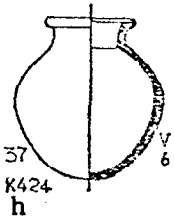
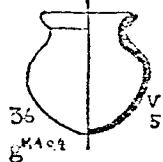
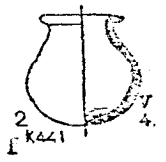
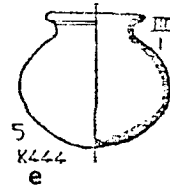
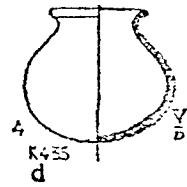
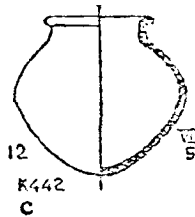
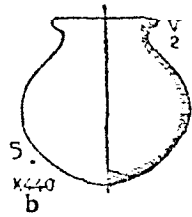
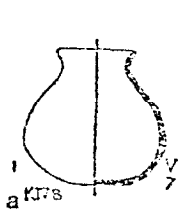

Fig. 201.--Kerma: Painted and Kerma Ware from K IV

Reisner, Excavations at Kerma, Parts IV-V.

a. P Fig. 340

b. P Fig. 340

c. RP Fig. 279

d. RP Fig. 279

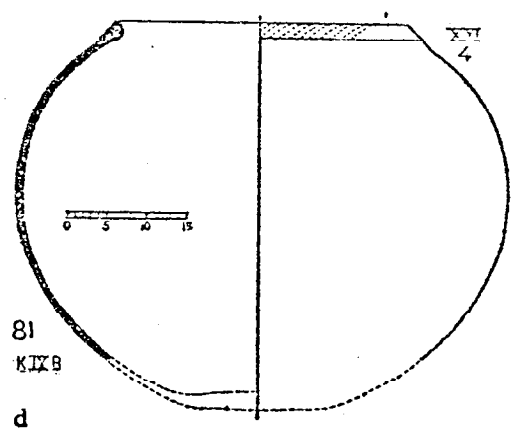
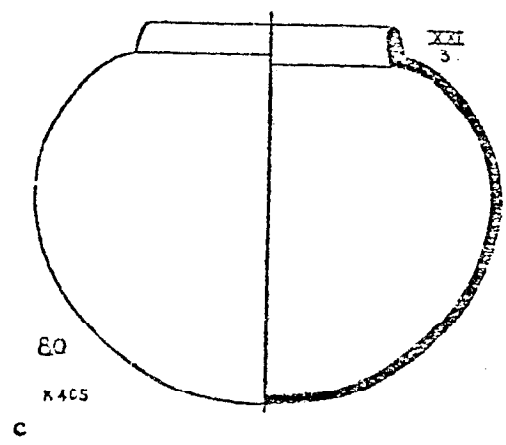
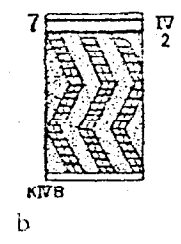
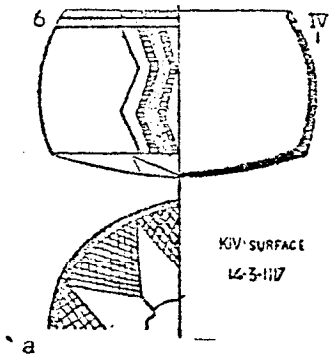

Fig. 202.--Kerma: Egyptianizing Wares from K IV

Reisner, Excavations at Kerma, Parts IV-V.

- | | |
|-----------|----------|
| a. KW | Fig. 321 |
| b. | Fig. 320 |
| c. KW | Fig. 320 |
| d. RW | Fig. 299 |
| e. RP | Fig. 270 |
| f. RW | Fig. 287 |
| g. BW | Fig. 289 |
| h. KW | Fig. 319 |
| i. KW | Fig. 319 |
| j. F Db W | Fig. 313 |
| k. PWSR | Fig. 307 |
| l. WSR | Fig. 303 |
| m. KW | Fig. 319 |
| n. KW | Fig. 319 |

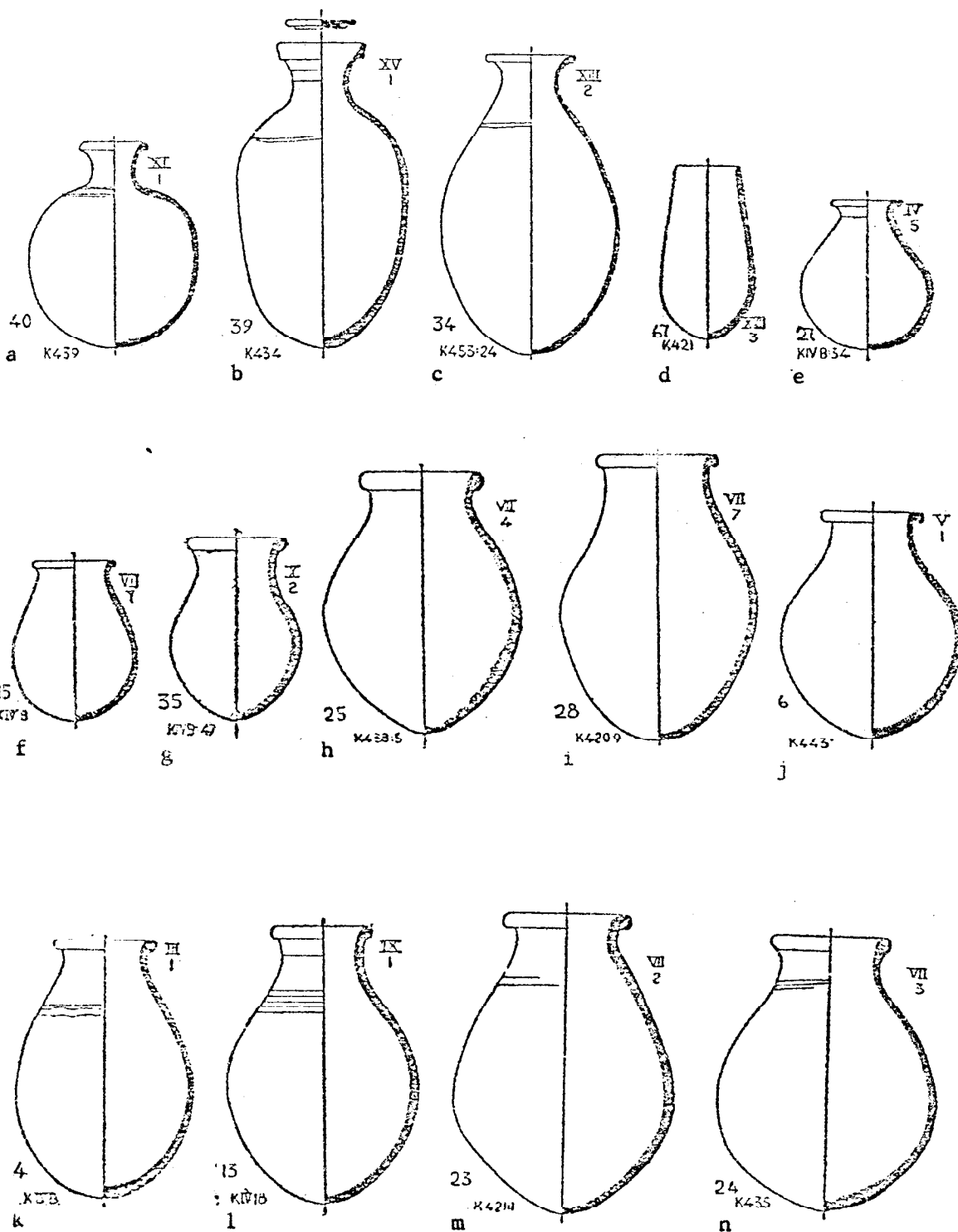

Fig. 203.--Kerma: Egyptianizing Wares from Kerma K IV (Cont.)

Reisner, Excavations at Kerma, Parts IV-V.

- a. RP Fig. 279
- b. RP Fig. 269
- c. RP Fig. 269
- d. RW Fig. 290
- e. RP Fig. 267
- f. RW Fig. 265
- g. WSR Fig. 306
- h. RP Fig. 275

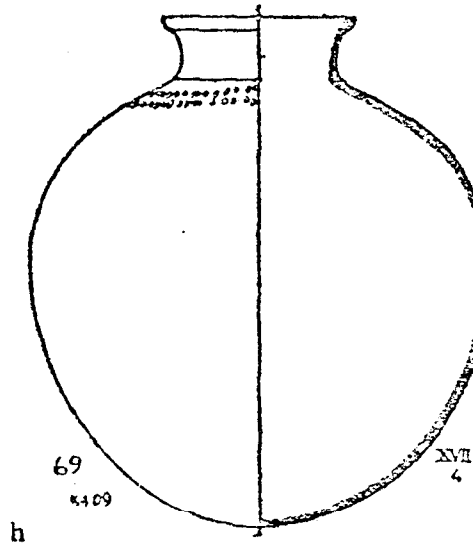
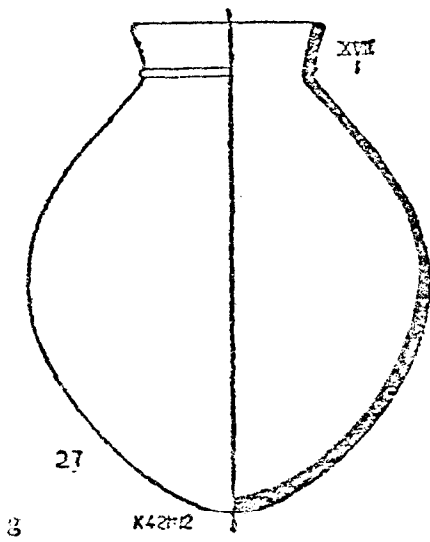
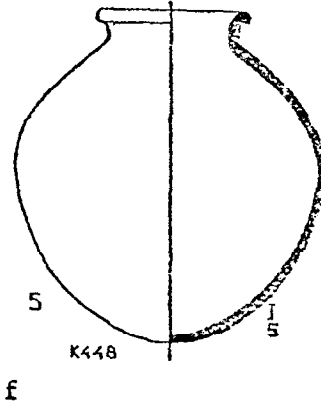
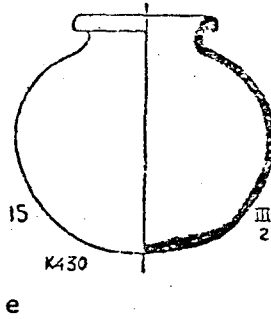
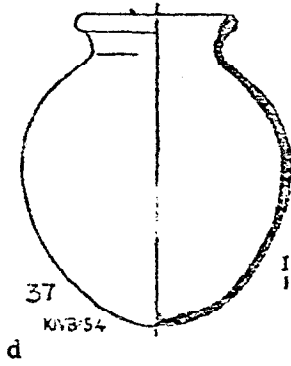
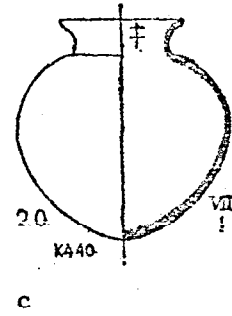
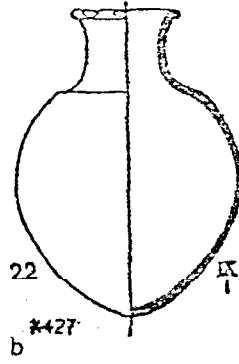
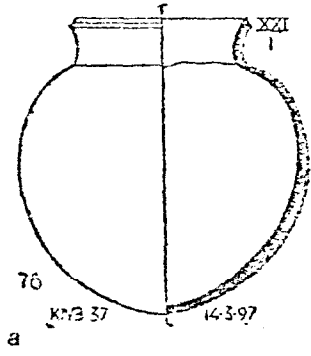

Fig. 204.--Kerma: Egyptianizing Wares from K IV (Cont.)

Reisner, Excavations at Kerma, Parts IV-V.

a. RW Fig. 293

b. RW Fig. 293

c. RP Fig. 269

d. WSR Fig. 305

e. RW Fig. 291

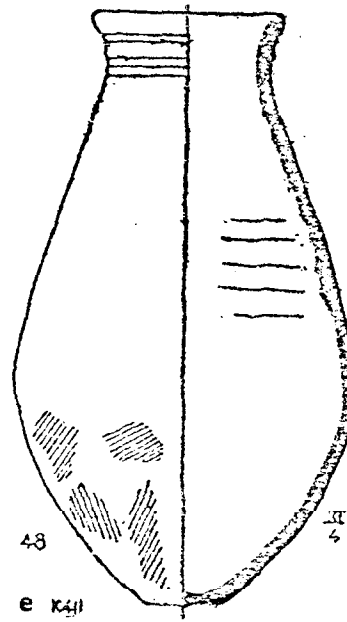
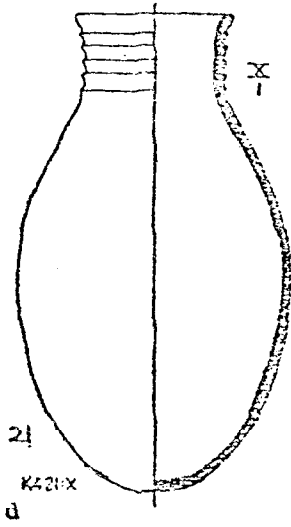
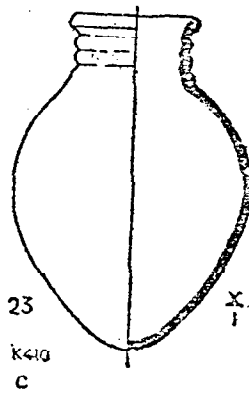
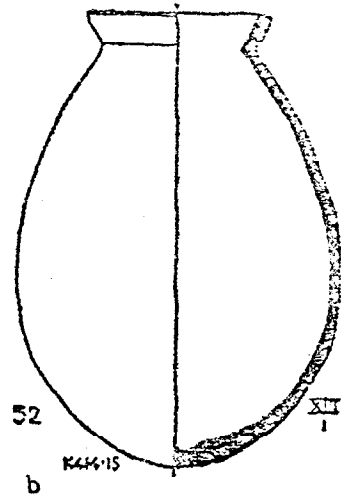
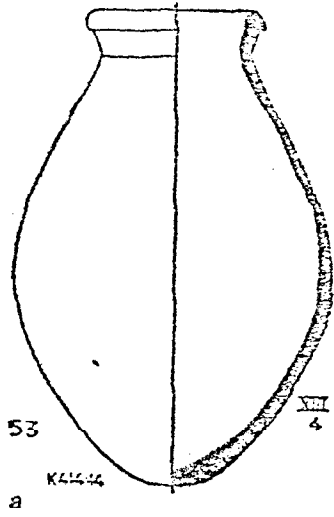

Fig. 205.--Kerma: Egyptianizing Wares from K X

Reisner, Excavations at Kerma, Parts IV-V.

a.	RW	Fig. 298
b.	RP	Fig. 281
c.	Db W	Fig. 311
d.	KW	Fig. 317
e.	WSR	Fig. 302
f.	PWSR	Fig. 307
g.	RW	Fig. 286
h.	RP	Fig. 270
i.	RP	Fig. 270
j.	RP	Fig. 270
k.	RW	Fig. 286
l.	RW	Fig. 286
m.	RP	Fig. 271
n.	KW	Fig. 217
o.	Db W	Fig. 213
p.	BP	Fig. 262
q.	RP	Fig. 270
r.	RW	Fig. 287
s.	RW	Fig. 286
t.	P	Fig. 340

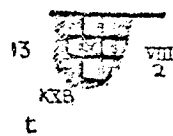
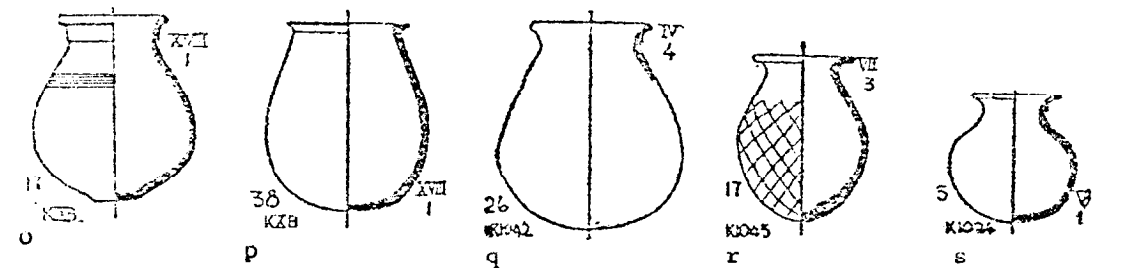
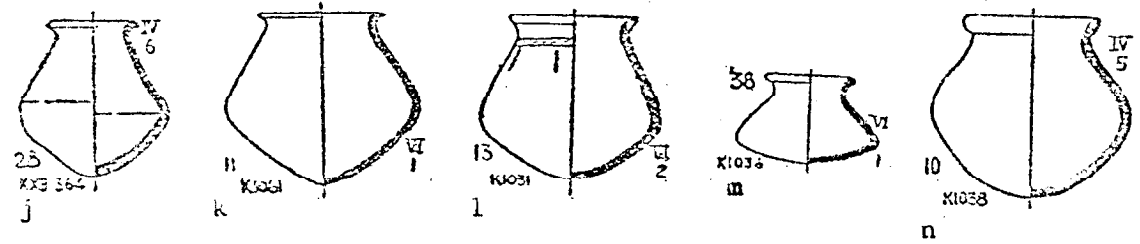
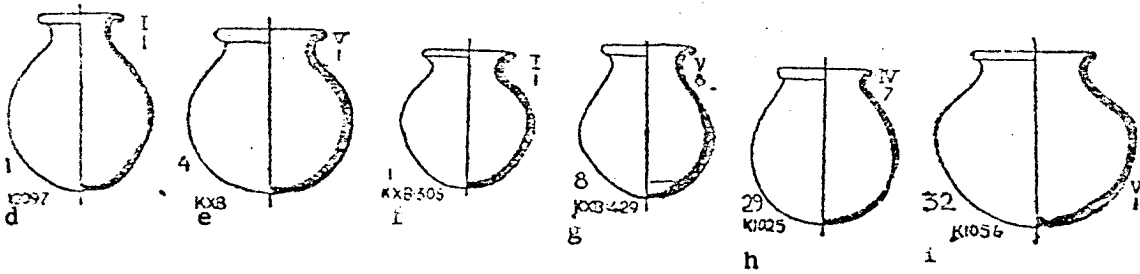
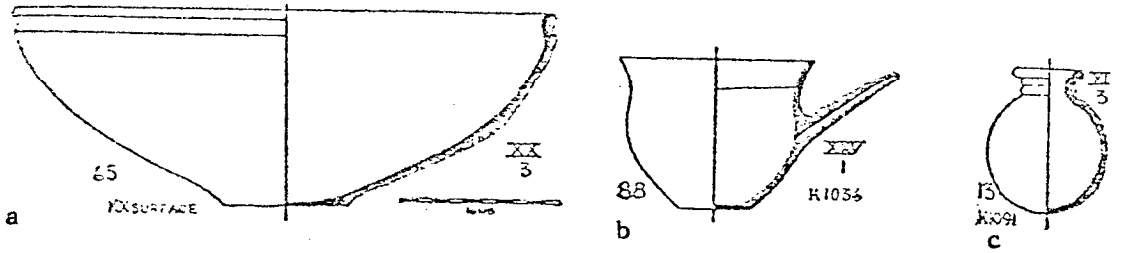

Fig. 206.--Kerma: Egyptianizing Wares from K X (Cont.)

Reisner, Excavations at Kerma, Parts IV-V.

- | | |
|-----------|----------|
| a. BP | Fig. 255 |
| b. KW | Fig. 321 |
| c. WSR | Fig. 302 |
| d. Db W | Fig. 311 |
| e. RW | Fig. 290 |
| f. RP | Fig. 266 |
| g. Db W | Fig. 309 |
| h. F Db W | Fig. 313 |
| i. RP | Fig. 271 |
| j. RP | Fig. 271 |
| k. RP | Fig. 271 |

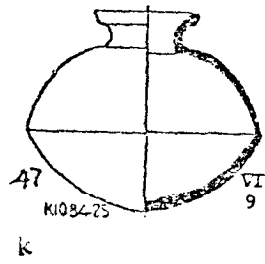
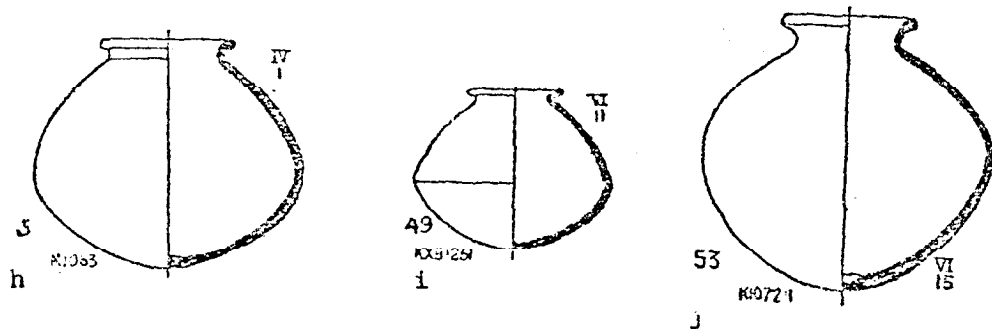
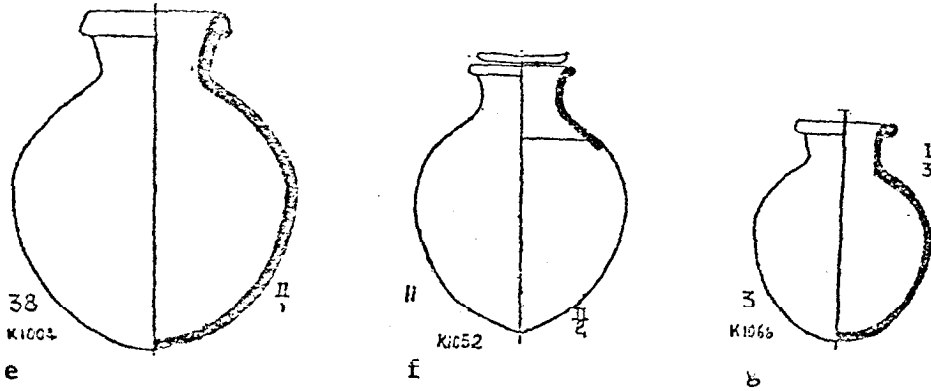
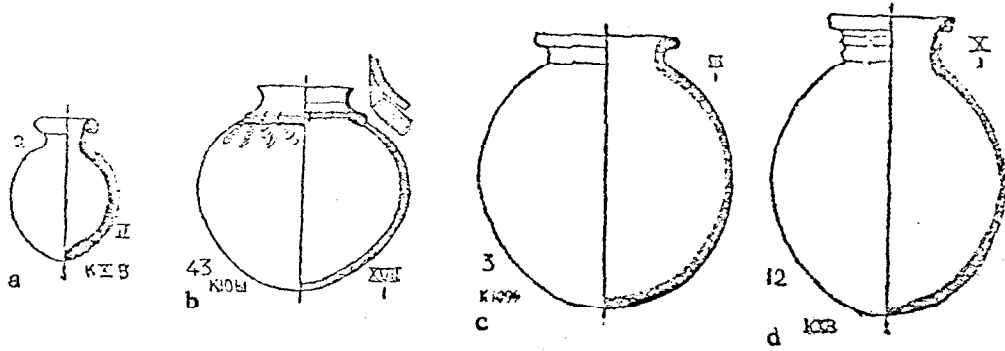

Fig. 207.--Kerma: Egyptianizing Wares from K X (Cont.)

Reisner, Excavations at Kerma, Parts IV-V.

- | | | |
|----|-----|----------|
| a. | RW | Fig. 299 |
| b. | RP | Fig. 265 |
| c. | RP | Fig. 265 |
| D. | WSR | Fig. 302 |
| e. | RW | Fig. 289 |
| f. | KW | Fig. 320 |
| g. | KW | Fig. 319 |
| h. | WSR | Fig. 303 |
| i. | KW | Fig. 319 |
| j. | RP | Fig. 268 |
| k. | WSR | Fig. 303 |

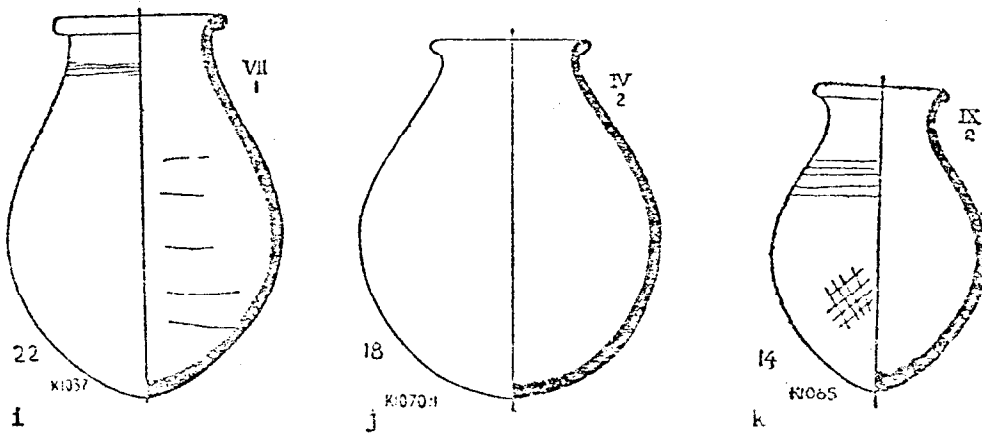
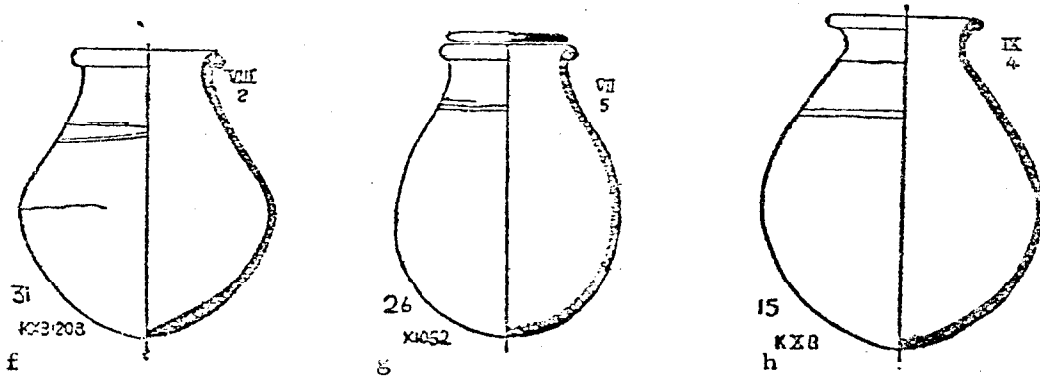
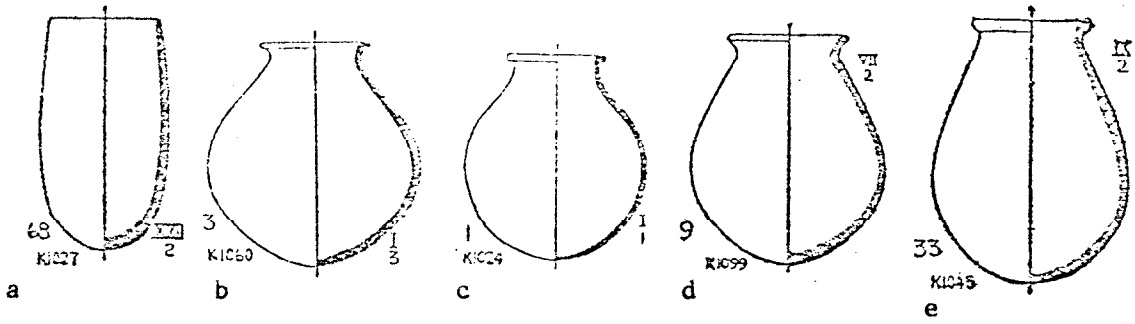

Fig. 208.--Kerma: Egyptianizing Wares from K X (Cont.)

Reisner, Excavations at Kerma, Parts IV-V.

- a. KW Fig. 293
- b. RW Fig. 293
- c. WSR Fig. 306
- d. WSR Fig. 306
- e. KW Fig. 321
- f. RW Fig. 293
- g. RP Fig. 275
- h. RW Fig. 295

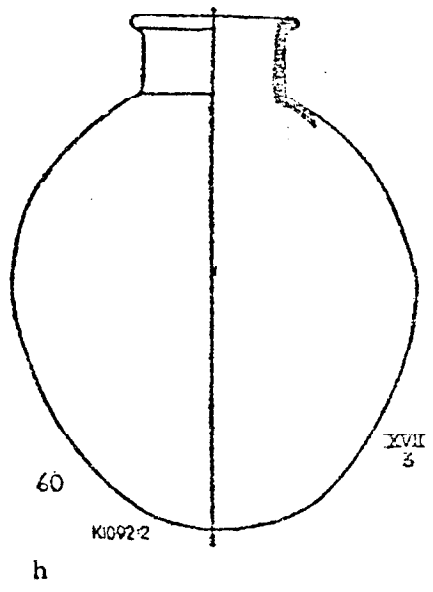
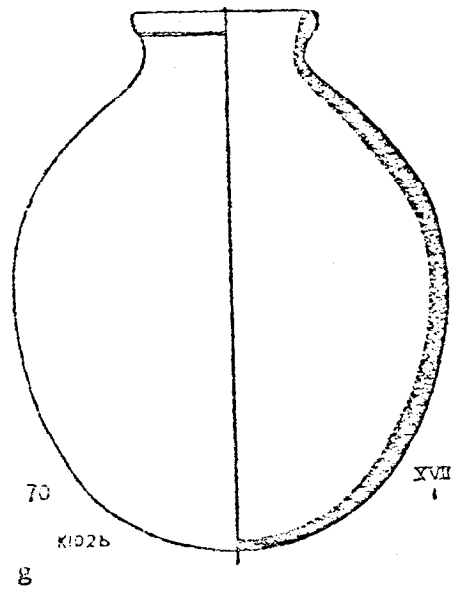
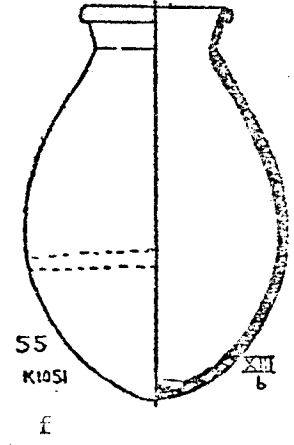
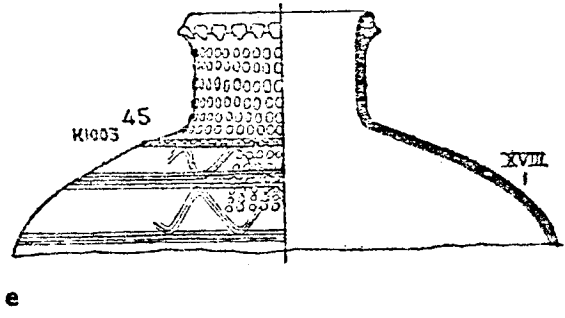
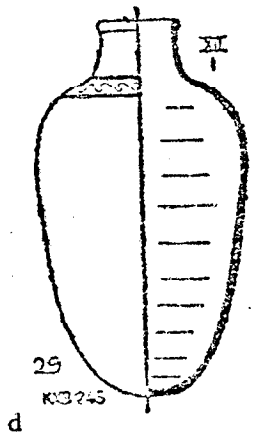
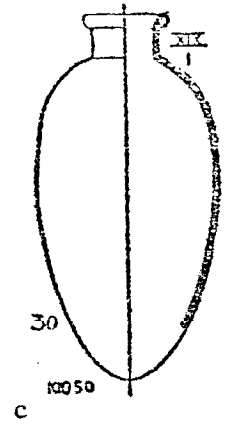
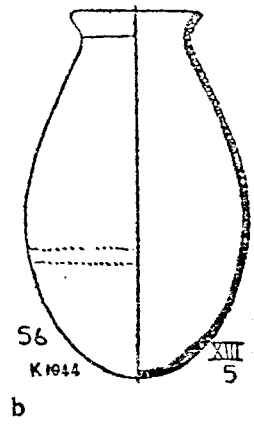
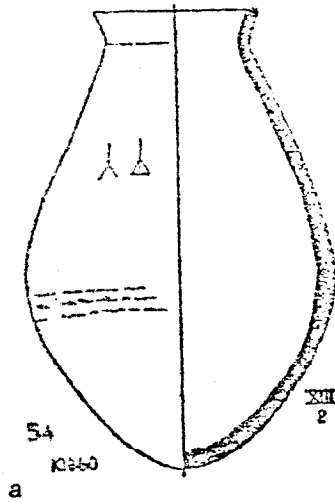
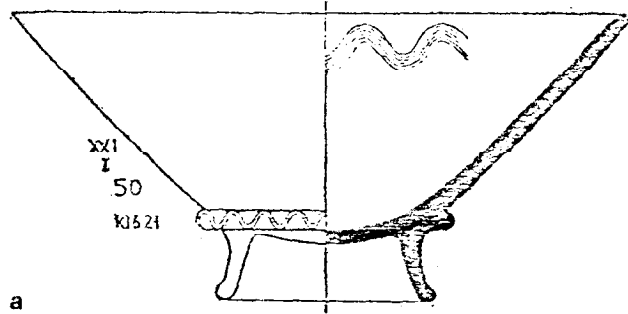

Fig. 209.--Kerma: Egyptianizing Pottery from K XVI

Reisner, Excavations at Kerma, Parts IV-V.

- a. KW Fig. 321
- b. Db W Fig. 309
- c. Db W Fig. 311
- d. KW Fig. 318
- e. RW Fig. 290
- f. RW Fig. 287
- g. RW Fig. 286
- h. RW Fig. 287
- i. KW Fig. 287
- j. BCR Fig. 335
- k. W P Grey Fig. 315
- l. W P Grey Fig. 315



a

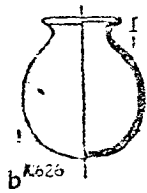

b



c

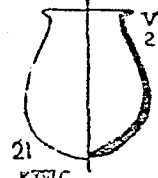

d

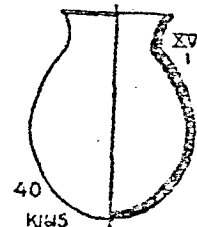

e

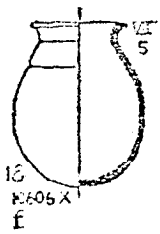

f

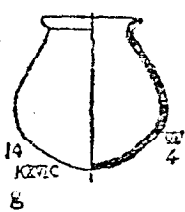

g

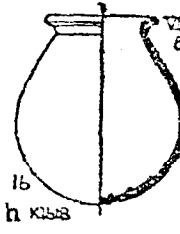

h

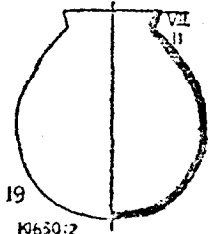

i

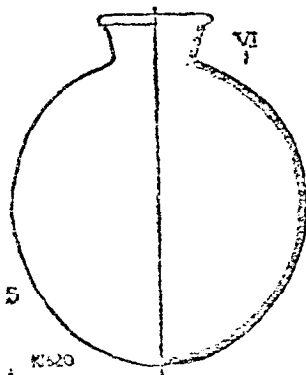

j

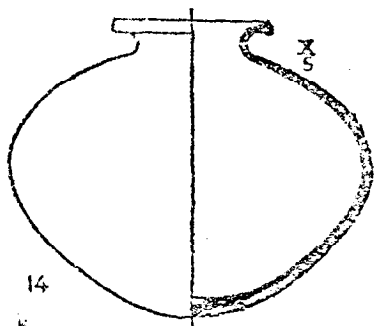

k

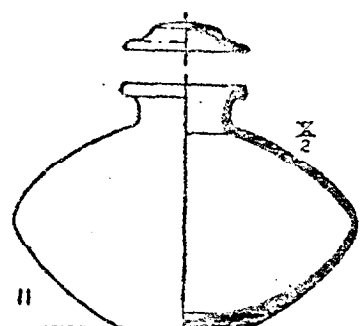

l

Fig. 210.--Kerma: Egyptianizing Wares from K XVI (Cont.)

Reisner, Excavations at Kerma, Parts IV-V.

- a. Db W Fig. 309
- b. CRW Fig. 330
- c. RW Fig. 289
- d. RP Fig. 268
- e. RW Fig. 288
- f. Db W Fig. 312
- g. KW Fig. 320

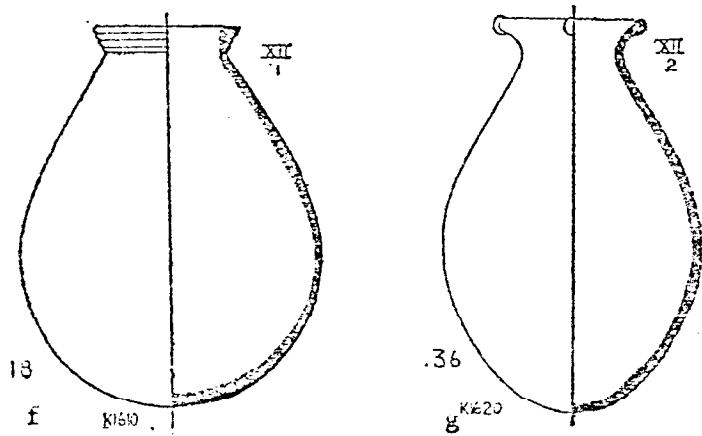
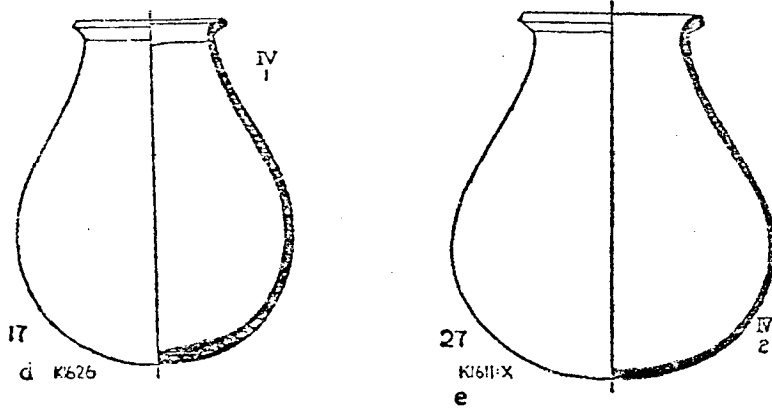
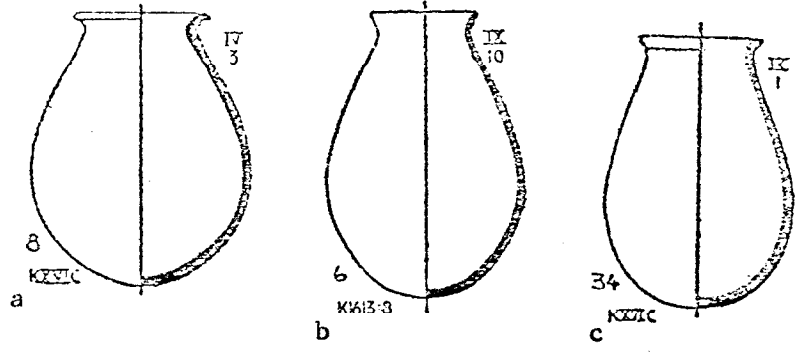

Fig. 211.--Buhen: Pottery and Objects from the Kerma Burial in
the Dromos of J33

MacIver and Woolley, Buhen.

- | | | |
|----|--------|----------|
| a. | 10611 | Plate 52 |
| b. | 10613 | Plate 52 |
| c. | 10612 | Plate 52 |
| d. | 10615 | Plate 52 |
| e. | 10614 | Plate 52 |
| f. | 10610 | Plate 52 |
| g. | 10609 | Plate 52 |
| h. | 10608 | Plate 52 |
| i. | 10347A | Plate 51 |
| j. | 10347B | Plate 51 |
| k. | 10341 | Plate 51 |

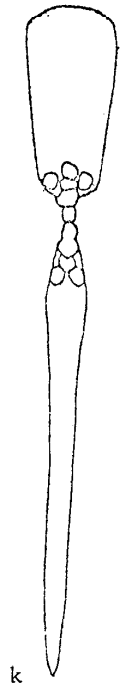
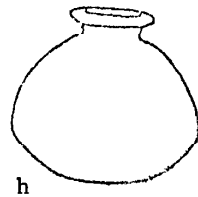
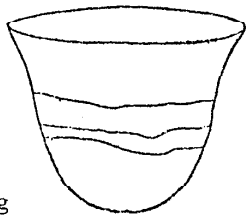
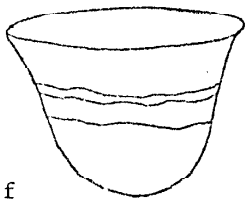
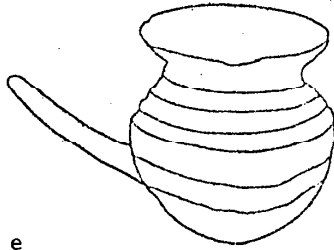
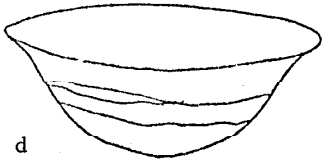
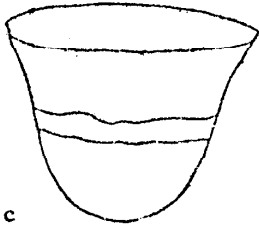
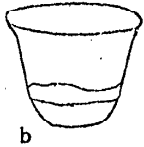
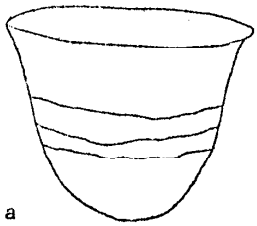

Fig. 212.--The Occurrence of Kerma Burials in Lower Nubia,
After Bietak

1. Kubban Cemetery 110
2. Qurta Cemetery 118
3. Wadi Alaqi Cemetery 113:50
4. Mediq Cemetery 147
5. Tumas Cemetery 189
6. Aniba, Cemetery at Nag el Tahuna
7. Adindan Cemetery K
8. Debeira Cemetery 170/13
9. Gezira Dabarosa
10. Euben Cemetery J
11. Mirgissa Cemetery M3

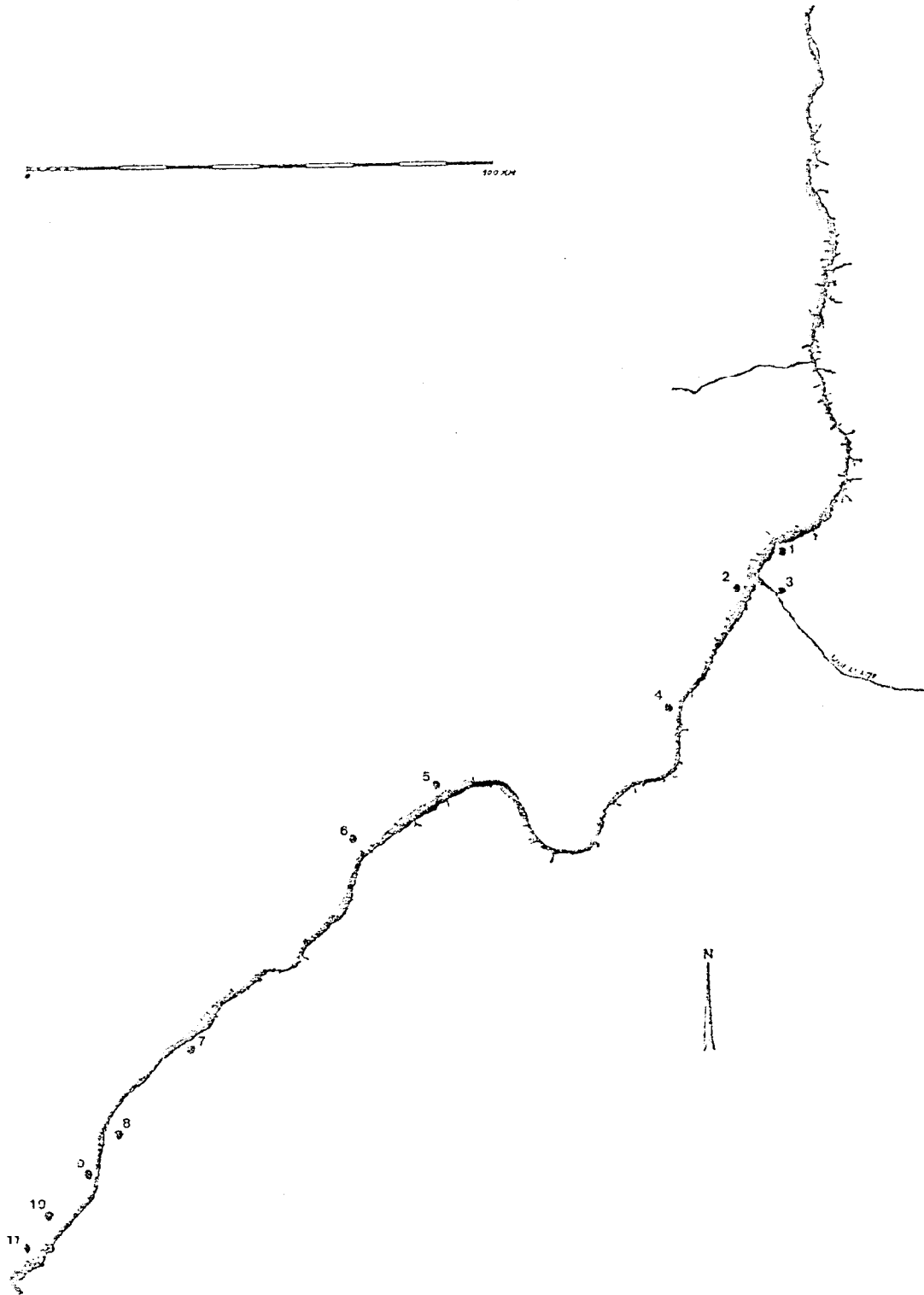

Fig. 213.--The Occurrence of Pan Graves in Lower Nubia, After
Bietak

1. Shellal Knoll B, Cemetery 7
2. Ginari Cemetery 58:1
3. Mo'alla Cemetery 68
4. Kubban Cemetery 110
5. Dakka Cemeteries 97 and 98
6. Dakka Cemetery 101
7. Qurta Cemetery 118
8. Sayala Camp
9. Sayala B
10. Sayala Cemetery 135
11. Sayala G 6-8
12. Tomas Cemetery 189
13. Aniba Cemetery N
14. Aniba Cemetery C
15. Masmas Cemetery 201
16. Adindan Cemetery K

NOTE: sites with only influence from the Pan Grave culture are not included.

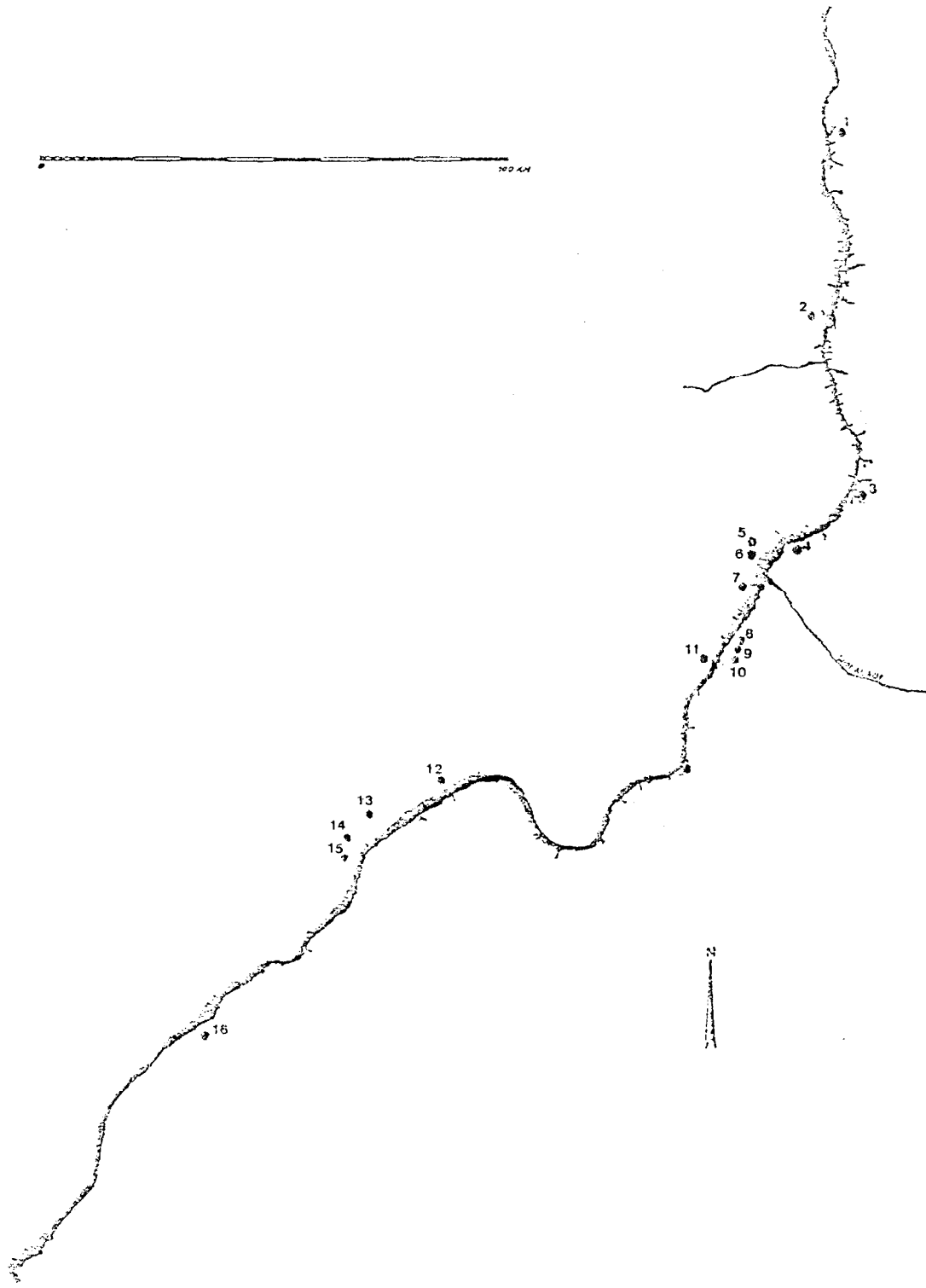
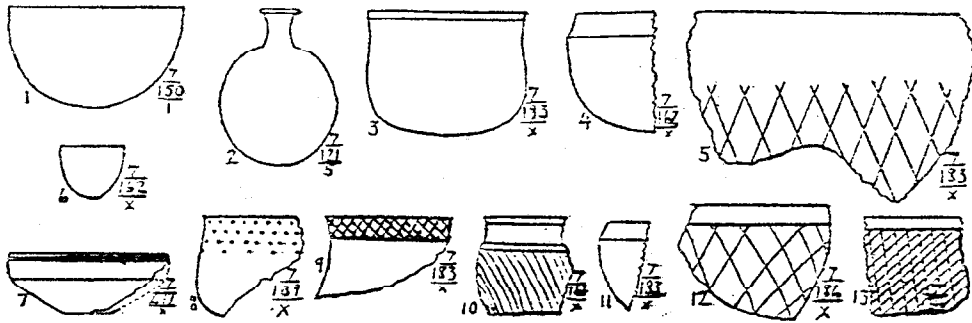

Fig. 214.--Shellal: Pottery and a burial from the Pan
Cemetery, Knoll B, Cemetery 7.

G. A. Reisner, The Archaeological Survey of Nubia; Re-
1907-1908.

a. Fig. 37.

b. Fig. 38.



a

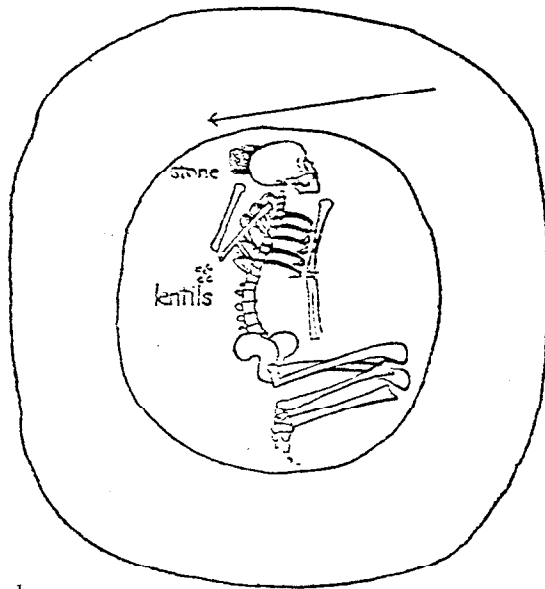

b

Fig. 215.--Aniba: Pan-Grave Pottery from Cemetery C
Steindorff, Aniba; Erster Band, Plate 31

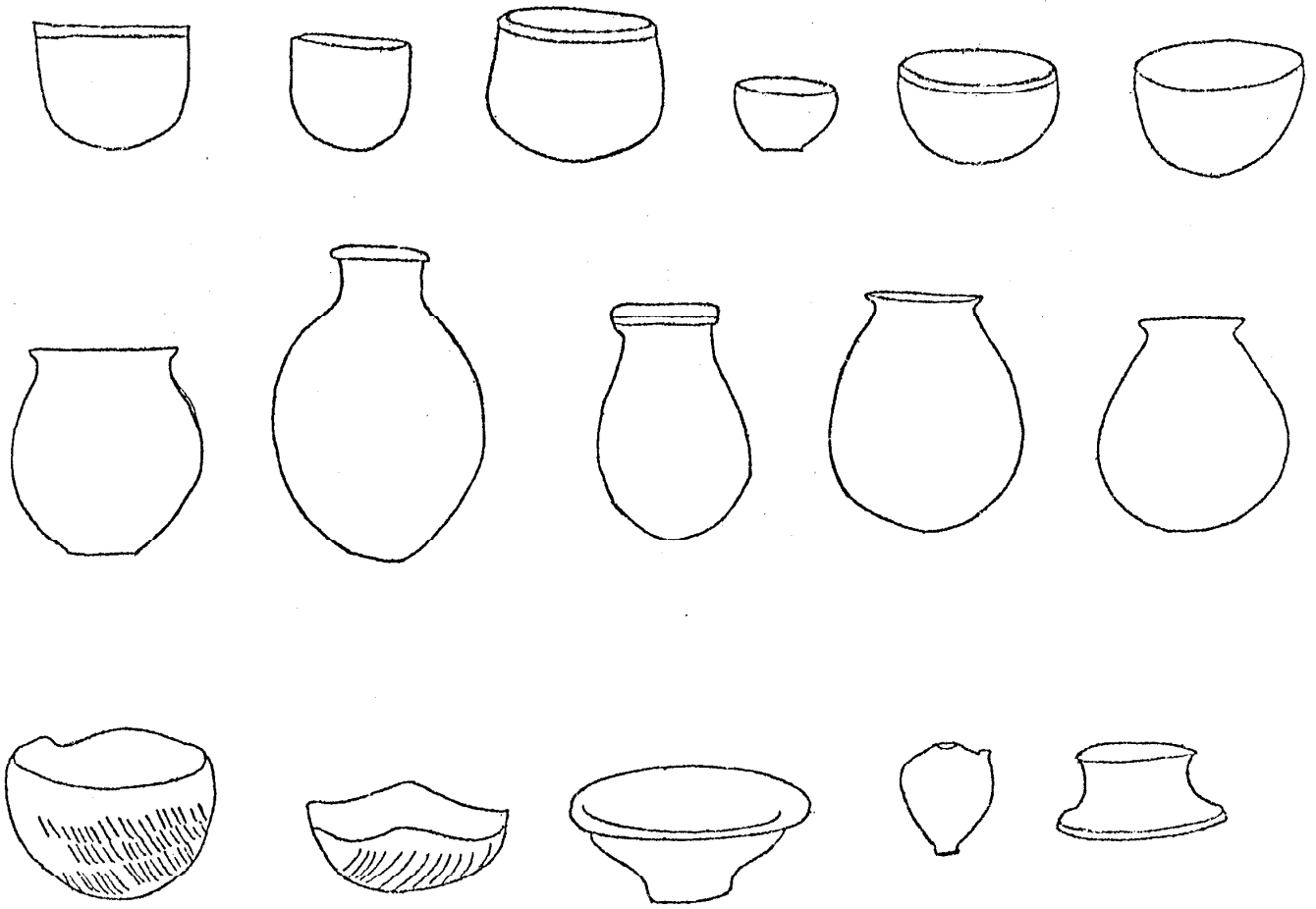

Fig. 216.--Aniba: Pan-Grave Pottery from Cemetery N

Steindorff, Aniba; Erster Band, Plate 58

a. 1 .

b. 2

c. 3

d. 6

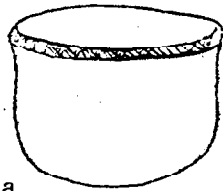

a



b

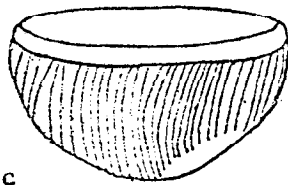

c

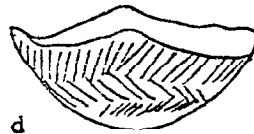

d

Fig. 217.--Kubban: Pottery of Thirteenth Dynasty and New Kingdom Date

Emery and Kirwan, The Excavations and Survey from Wadi es-Sebua to Adincan.

a. Cem. 110, Tomb 33 Page 57

b. Cem. 110, Tomb 1 Page 55

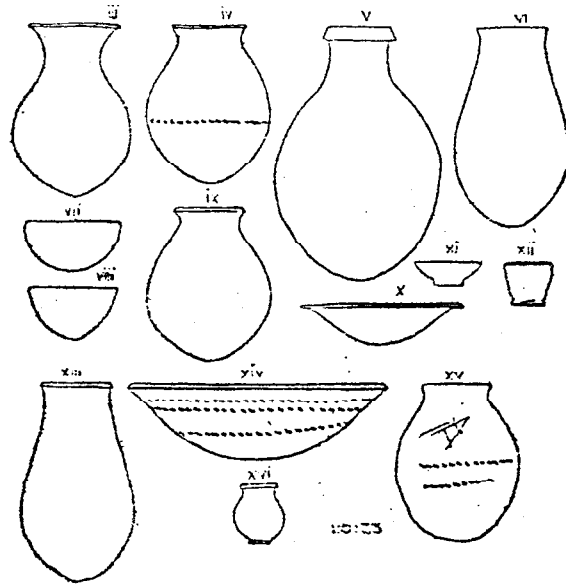

a

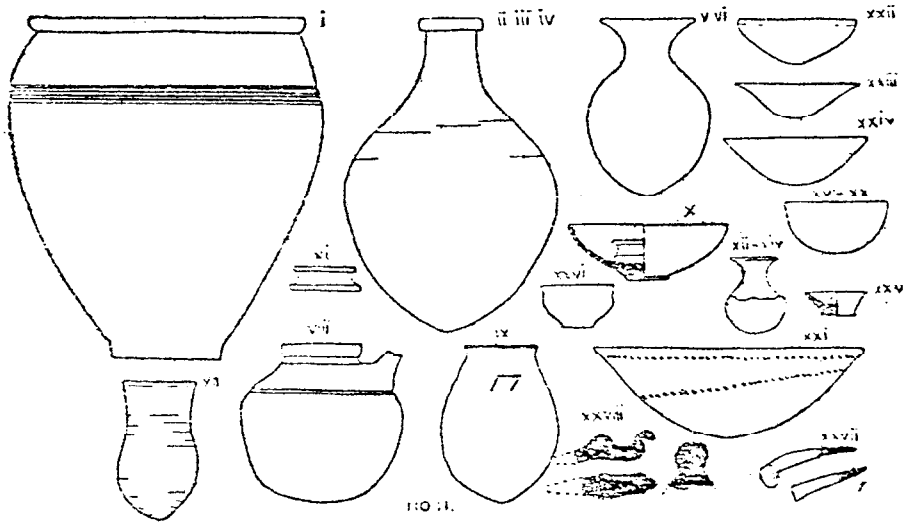

b

Fig. 218.--Kubban: Pottery of Thirteenth Dynasty and New Kingdom Date (Cont.)

Emery and Kirwan, The Excavations and Survey from Wadi es-Sebua to Adindan.

a. Cem. 110, Tomb 37 Page 58

b. Cem. 110, Tomb 267 Page 90

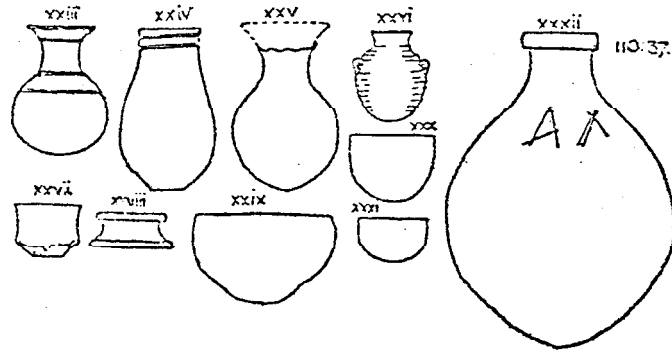

a

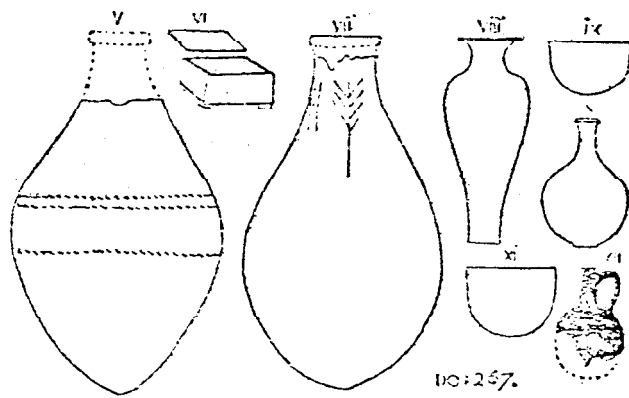

b

Fig. 219.--Aniba: Late Middle Kingdom (XII-XIIIth Dynasty)
Egyptian Pottery from S 110

Steindorff, Aniba: Zweiter Band, Plate 76 - 21.

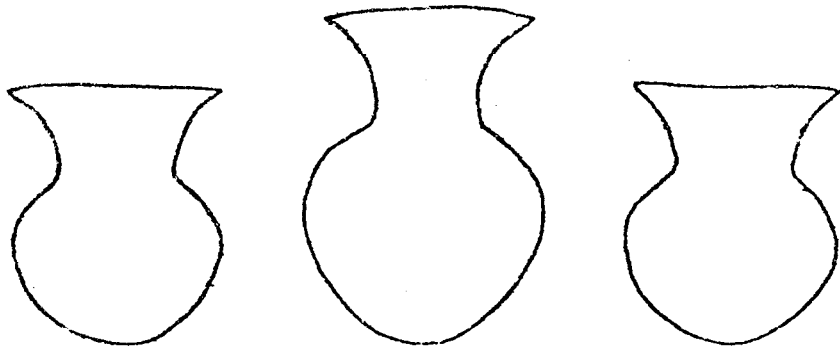

Fig. 220.--Aniba: Egyptian Pottery of the Hyksos Age from Cemetery 3

Steindorff, Aniba: Zweiter Band, Plate 67.

795

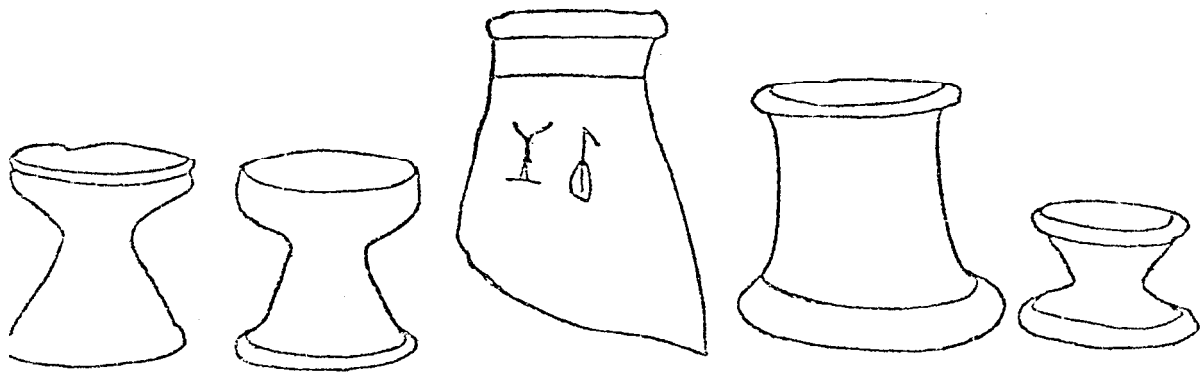
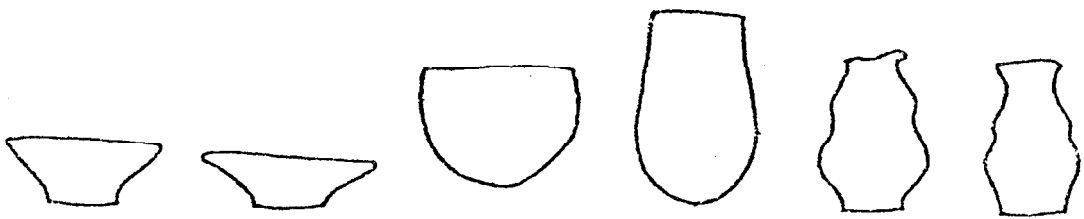
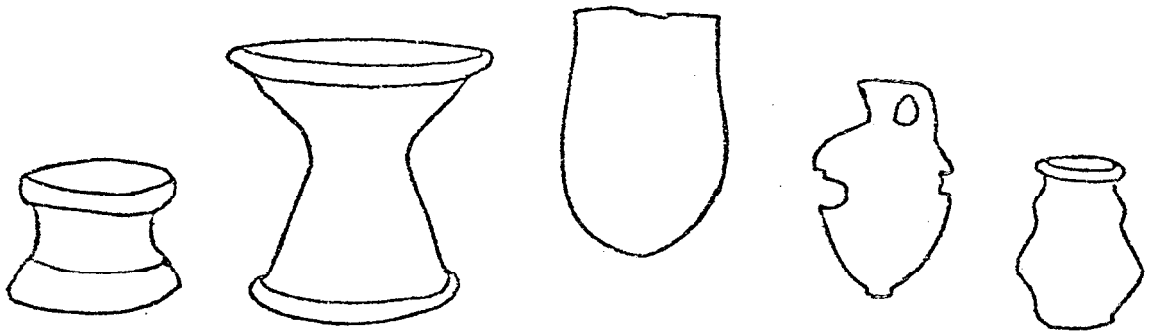
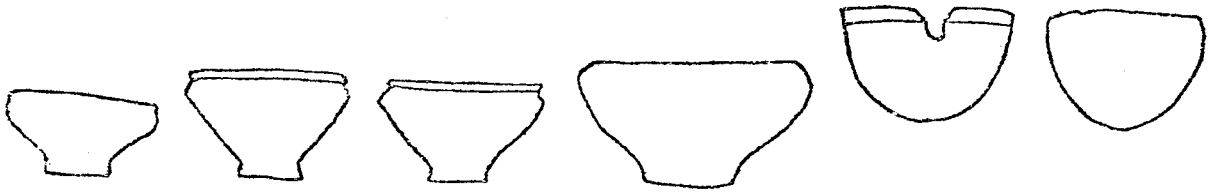

Fig. 221.--Aniba: Egyptian and Nubian Pottery from Cemetery B
Steindorff, Aniba: Erster Band, Plate 87.

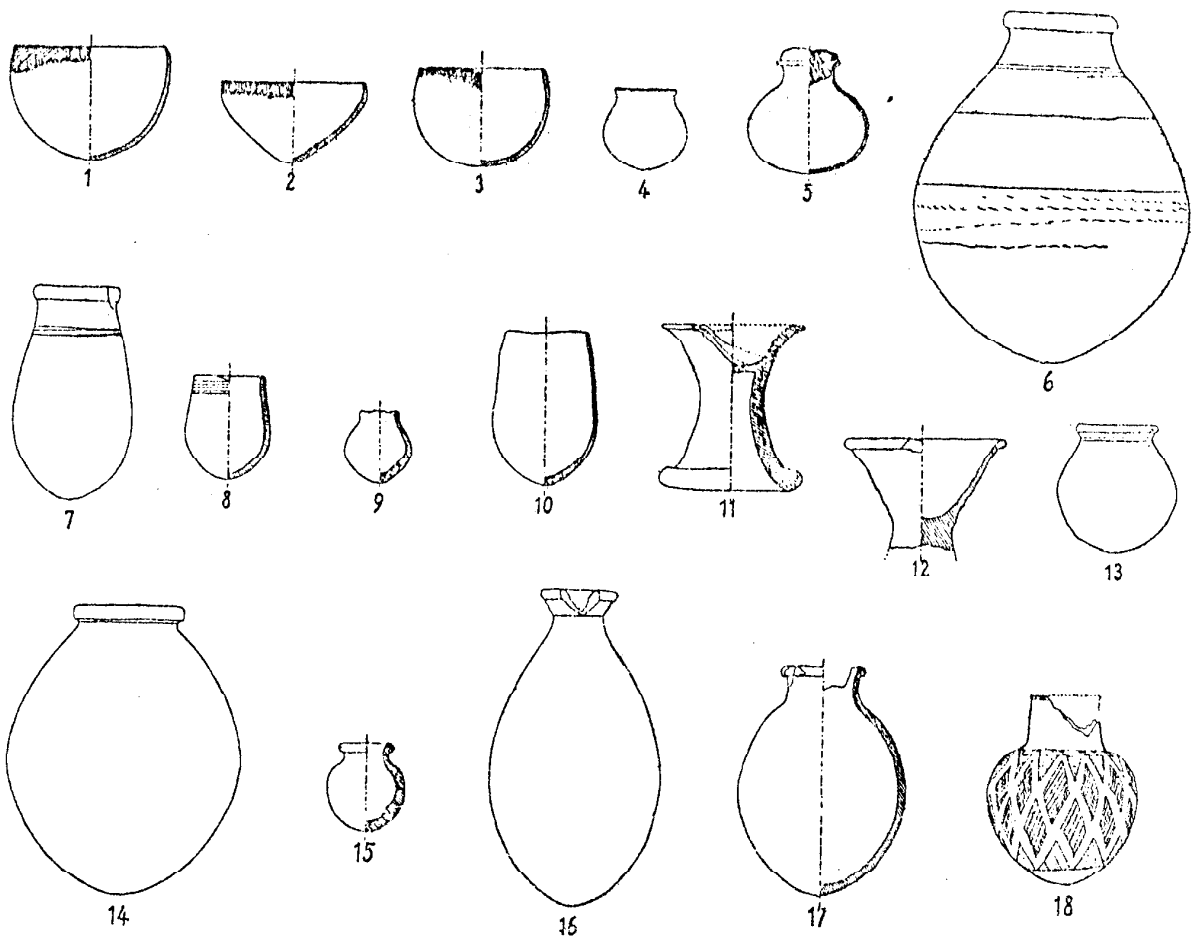

Fig. 222.--Aniba: Yehudiyya Ware from Cemetery S
Steindorff, Aniba: Zweiter Band, Plate 86-45.

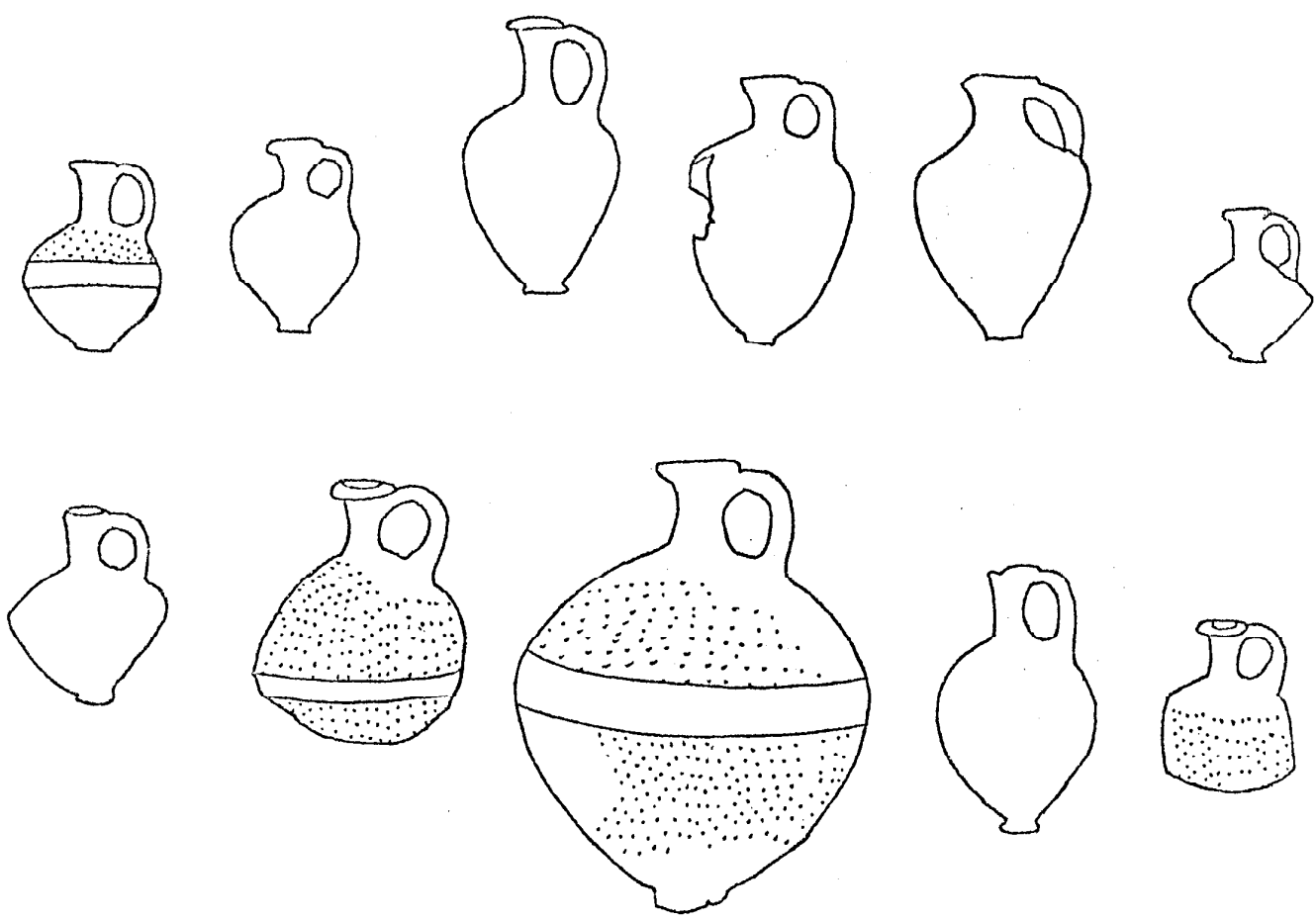
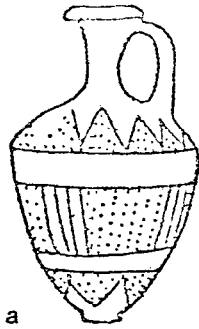

Fig. 223.--Ruhen: Yehudiyya Ware

MacIver and Woolley, Buhen, Plate 49.

a.	Early Yehudiyya Juglet	10765
b.	Late Yehudiyya Juglet	10617
c.	Late Yehudiyya Juglet	10621
d.	Late Yehudiyya Juglet	10527
e.	Late Yehudiyya Juglet	10531
f.	Late Yehudiyya Juglet	10501
g.	Undecorated Juglet	10619
h.	Undecorated Juglet	10499



a

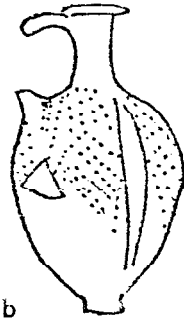

b

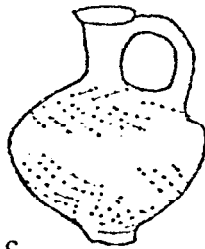

c

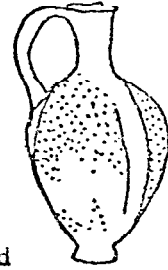

d

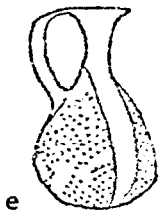

e



f

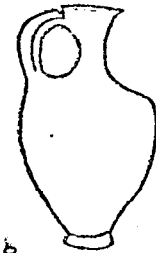

g

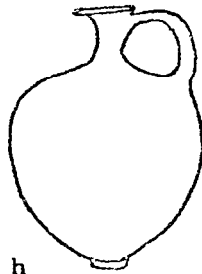

h

Fig. 224.--Buhen: Yehudiyya Ware and Other Juglets

MacIver and Woolley, Ruhen, Plate 92

a.	Juglet No.	10864
b.	Juglet No.	10869
c.	Late Yehudiyya Juglet No.	10876
d.	Juglet No.	10877
e.	Juglet No.	10871
f.	Juglet No.	10886
g.	Juglet No.	10887
h.	Juglet No.	10889
i.	Juglet No.	10890

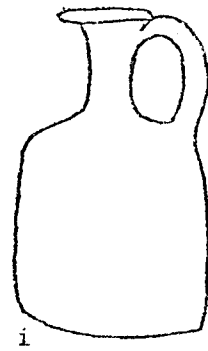
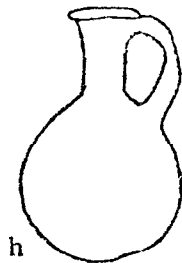
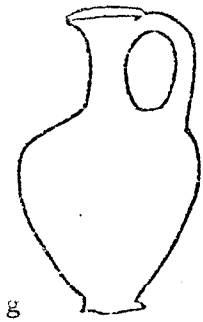
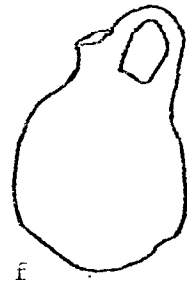
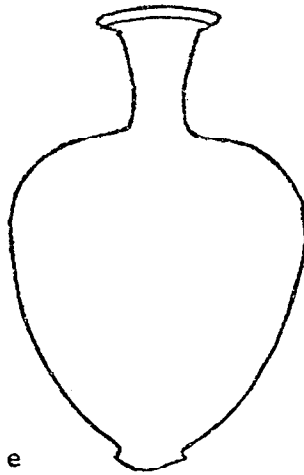
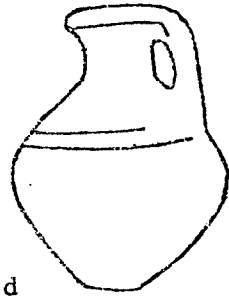
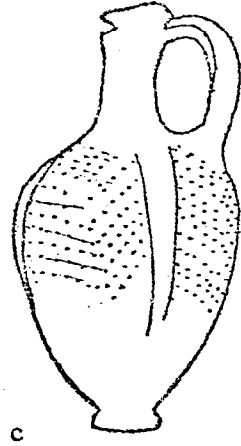
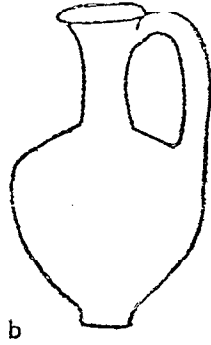
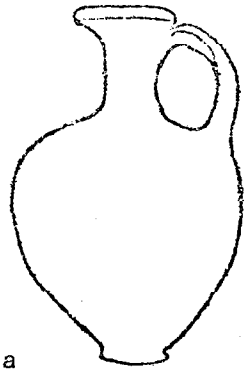

Fig. 225.--Buhen: Egyptian Pottery of the Late Thirteenth
Dynasty and the Hyksos Age

MacIver and Woolley, Buhen.

Plate 95:

- a. Type x
- b. Type xi
- c. Type xii
- d. Type xiii
- e. Type xiv
- f. Type xv
- g. Type xvi
- h. Type xvii
- i. Type xviii
- j. Type xix
- k. Type xx
- l. Type xxi
- m. Type xxii
- n. Type xxiii
- o. Type xxiv
- p. Type xxv
- q. Type xxvi
- r. Type xxvii
- s. Type xxviii
- t. Type xxix
- u. Type xxx
- v. Type xxxi

Plate 50:

- w. 10738 from Tomb K5

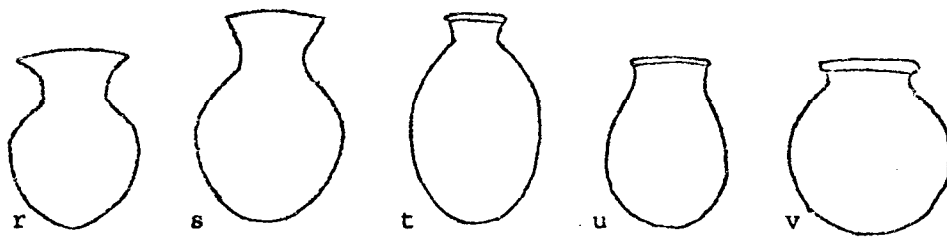
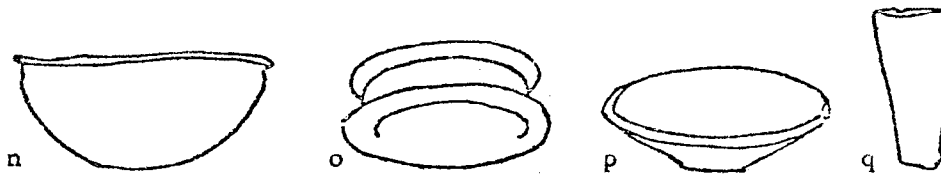
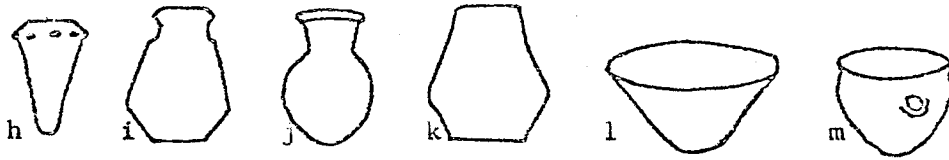

Fig. 226.--Buhen: Egyptian Pottery of the Late Thirteenth
Dynasty and the Hyksos Age (Cont.)

MacIver and Woolley, Buhen.

- | | | |
|----|----------|-----------|
| a. | Plate 93 | Type ii |
| b. | Plate 93 | Type i |
| c. | Plate 94 | Type viii |
| d. | Plate 93 | Type iii |
| e. | Plate 94 | Type iv |
| f. | Plate 94 | Type v |
| g. | Plate 94 | Type vi |
| h. | Plate 94 | Type vii |

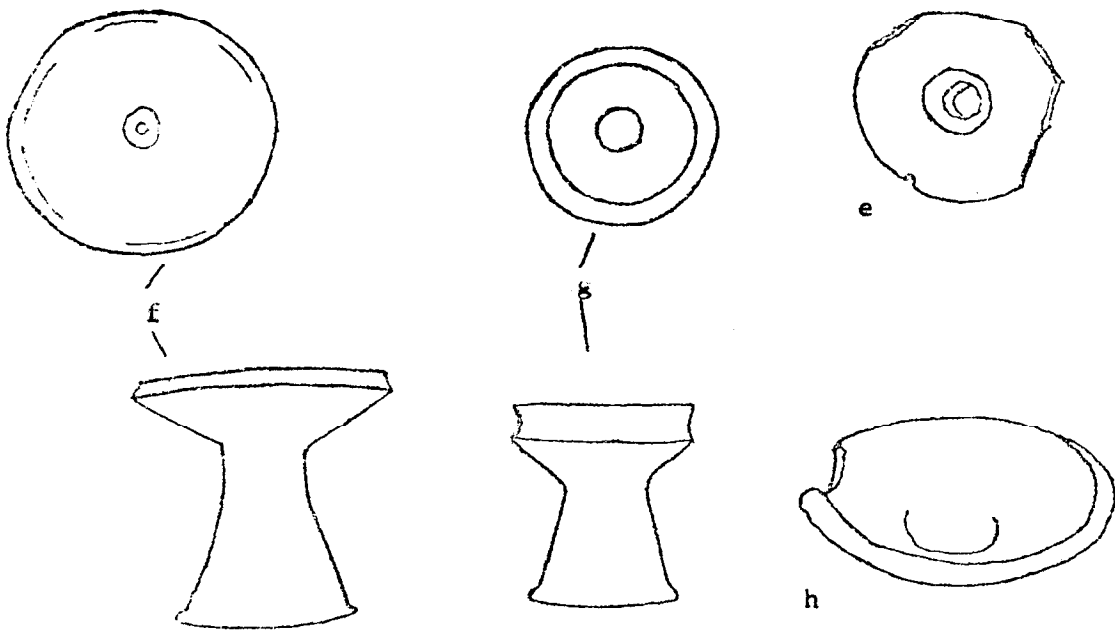
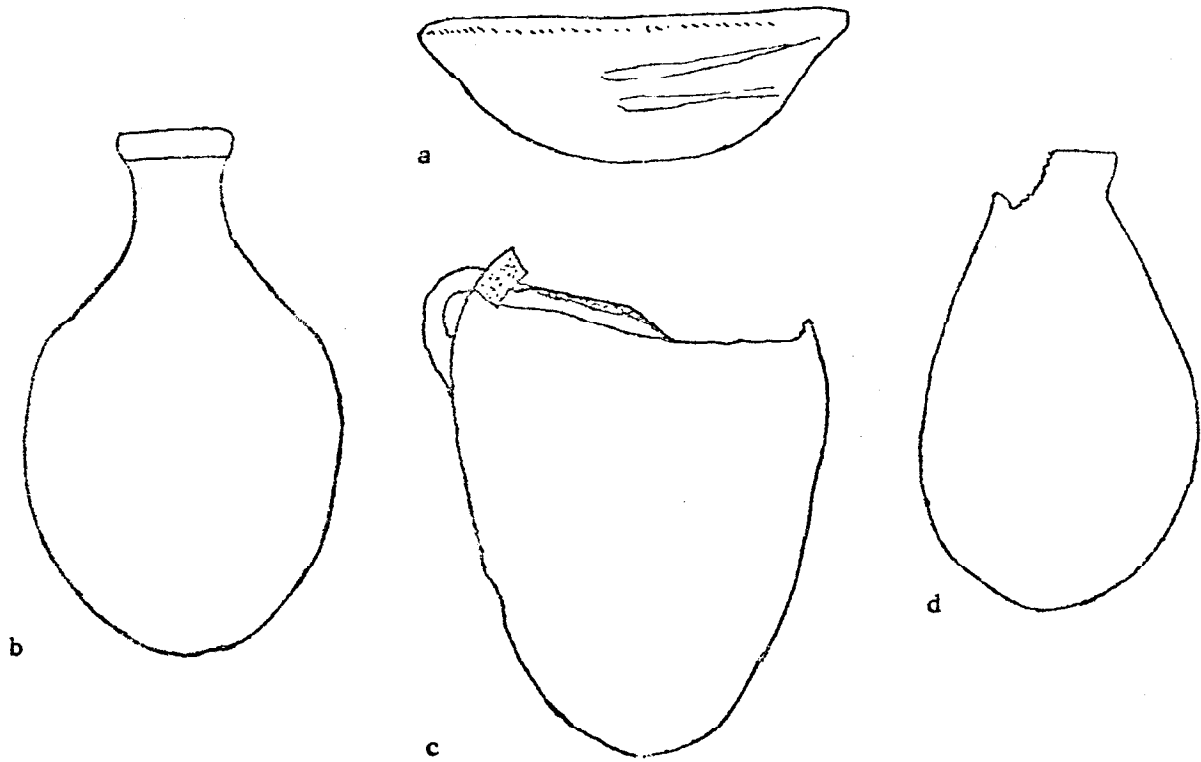

Fig. 227.--Buhen: Late Middle Kingdom (Late XII-XIIIth Dynasty)
Pottery from the "New Kingdom" Cemetery

MacIver and Woolley, Buhen.

a. Plate 45 S V

b. Plate 48 S LX VIII

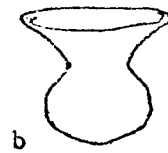
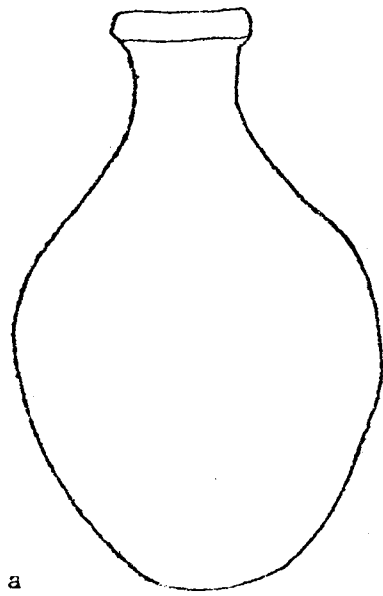
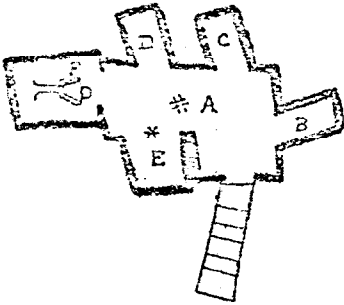

Fig. 228.--Buhen: Dromos Tombs, All with the Broad Anteroom
Except c and d

MacIver and Woolley, Buhen.

- | | | |
|----|-----|----------|
| a. | K 8 | Page 200 |
| b. | K27 | Page 189 |
| c. | K13 | Page 204 |
| d. | K 3 | Page 193 |
| e. | K24 | Page 206 |
| f. | K24 | Page 188 |
| g. | K26 | Page 207 |
| h. | K28 | Page 205 |

Tomb K 13.



a Scale, 1 : 250.

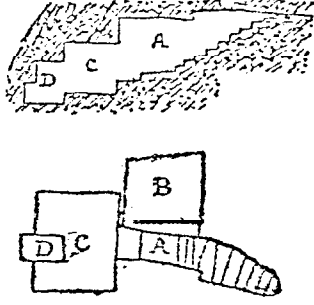

b Section and ground-plan of K 27.
Scale, 1 : 200.

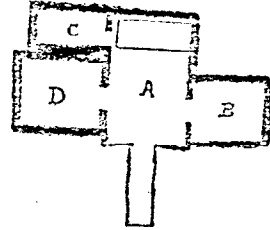

c Scale, 1 : 250.

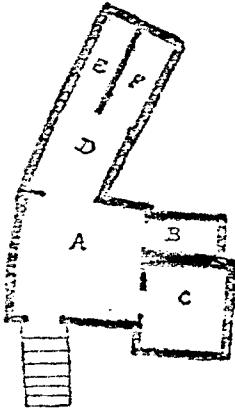

d Scale, 1 : 250.

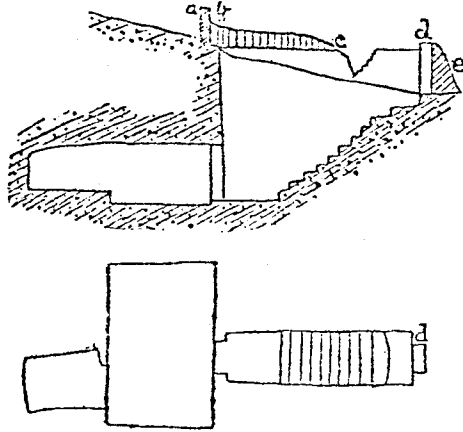

e Section and ground-plan of K 24. Scale, 1 : 200.

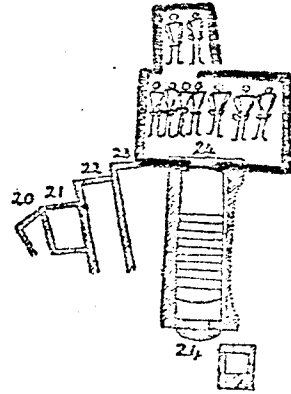

f Scale, 1 : 250.

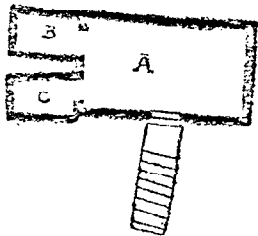

g Scale, 1 : 250.

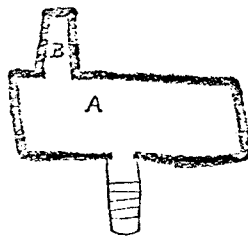

h Scale, 1 : 250.

Fig. 229.--Buhen: Dromos-Tombs with the Broad Anteroom

MacIver and Woolley, Buhen.

a. K34 Page 212

b. K37 Page 212

c. K37 Page 190

d. J32 Page 174

e. J23 Page 172

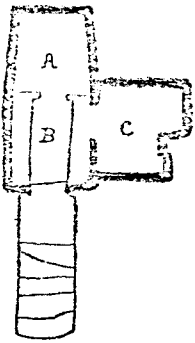

a Scale, 1 : 250.

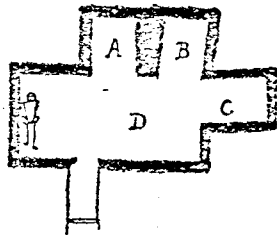
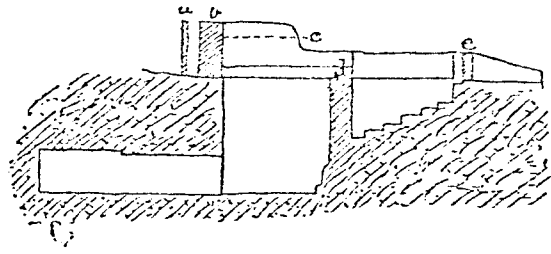

b Scale, 1 : 250.

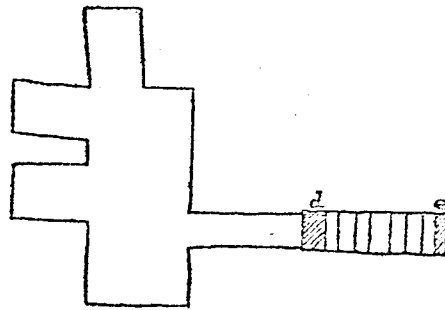

c Section and ground-plan of K 37. Scale, 1 : 200.



d Scale, 1 : 250.



e Scale, 1 : 250.

Fig. 230.--Buhen: Dromos-Tombs with Long Anterooms

MacIver and Woolley, Buhen.

a. K 9 Page 202

b. J27 Page 172

c. K12 Page 203

d. J33 Page 174

e. K32 Page 210

f. K45 Page 215

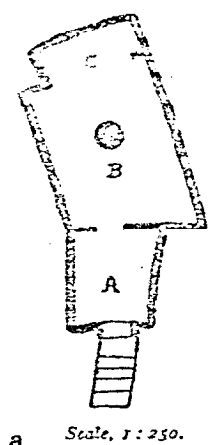

Scale, 1:250.

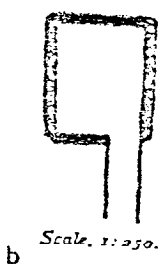

Scale, 1:250.

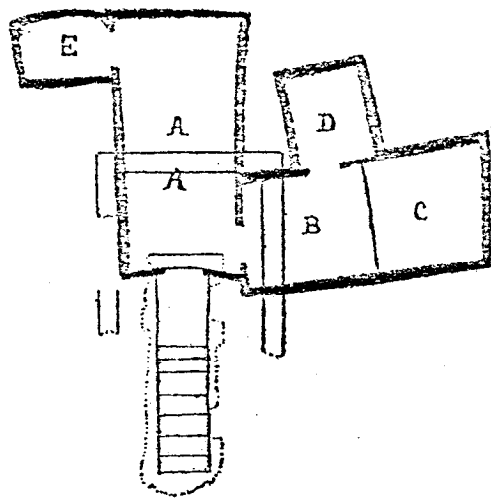

Superstructure and substructure of K 12. Scale, 1:200.

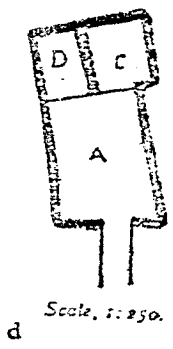

Scale, 1:250.

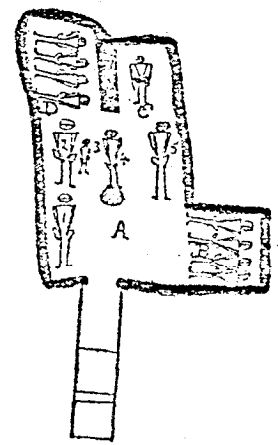

Scale, 1:250.

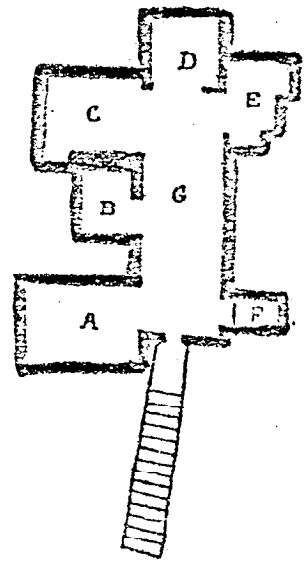

Scale, 1:250.

Fig. 231.--Buhen: Vaulted Trench Tombs and Tombs with a Square
or Long Anteroom

MacIver and Woolley, Buhen.

- | | | |
|----|--------|--|
| a. | K44 | Page 214 |
| b. | K39-43 | Page 213--Note obelisks for K39, possibly some for K38 |
| c. | K19 | Page 191 |
| d. | K 1 | Page 197 |
| e. | K 2 | Page 197 |
| f. | K 6 | Page 199 |
| g. | K16 | Page 205 |
| h. | K25 | Page 189 (Superstructure) |
| i. | K25 | Page 207 (Substructure) |

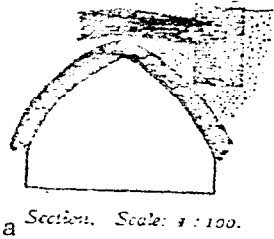

a Section. Scale: 1:100.

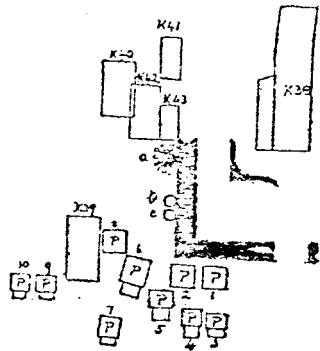

b Scale, 1:250.

Tomb K 39
to
Tomb K 243.

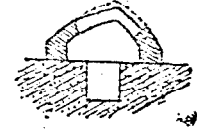
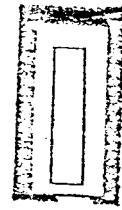

Ground-plan and
section of K 10.
c Scale, 1:100.

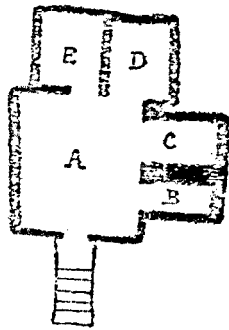

d Scale, 1:250.

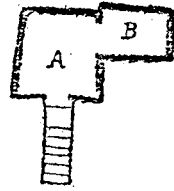

e Scale, 1:250.



f Scale, 1:250.

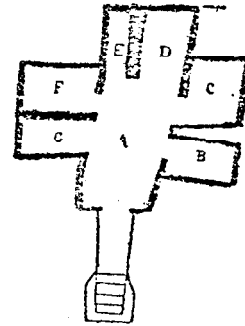

g Scale, 1:250.

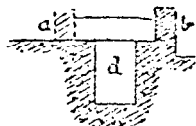
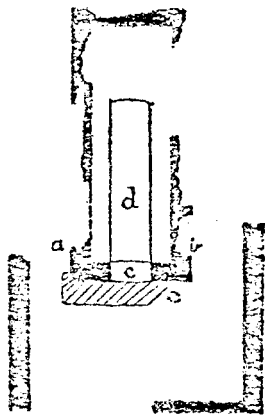

Plan and section of the dromos
of K 25. Scale, 1:200.

h

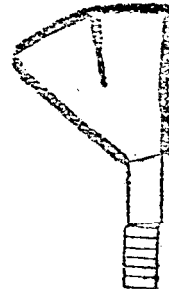

i Scale, 1:250.

Fig. 232.--Buhen: Dromos-Tombs with Square or Long Anterooms
and Shaft Tombs

MacIver and Woolley, Buhen.

- a. K38 Page 213
- b. K11 Page 203
- c. K12 Page 203
- d. K31 Page 209
- e. H76 Page 163
- f. H78 Page 163
- g. J41 Page 177
- h. H 1 Page 137
- i. H31 Page 152

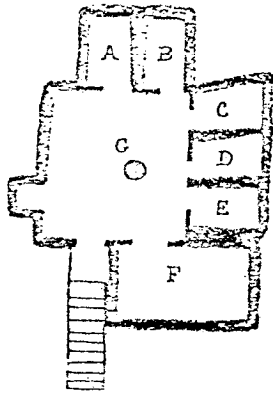

a Scale, 1:250.

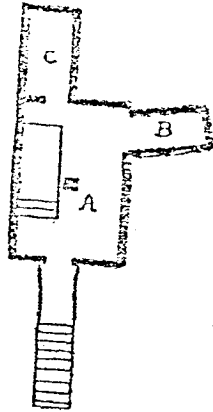

b Scale, 1:250.

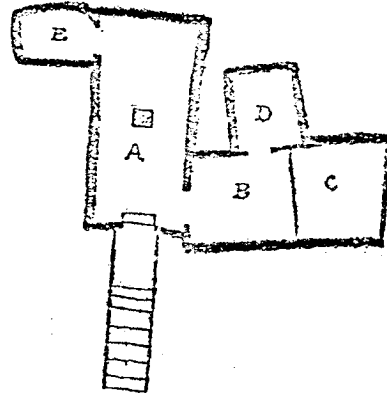

c Scale, 1:250.

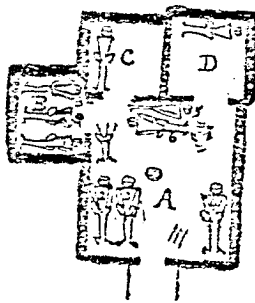

d Scale, 1:250.

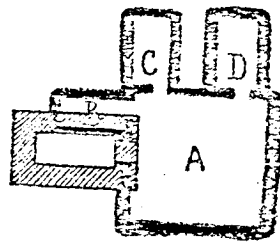

e Scale, 1:250.

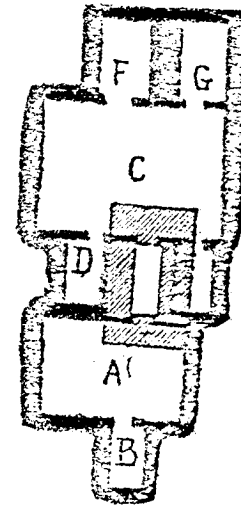

f Scale, 1:250.

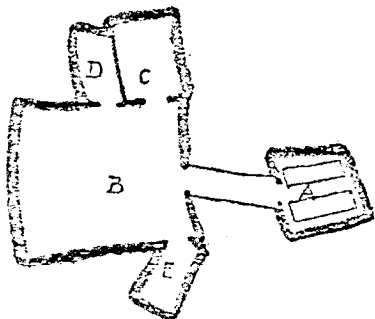

g Scale, 1:250.

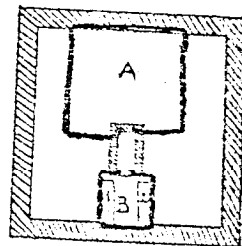

h Scale, 1:500.



i Scale, 1:500.

Fig. 233.--Aniba: Dromos-Tomb S31 with Obelisks and Shaft
Tomb S41

Steindorff, Aniba: Zweiter Band, Plan 19.

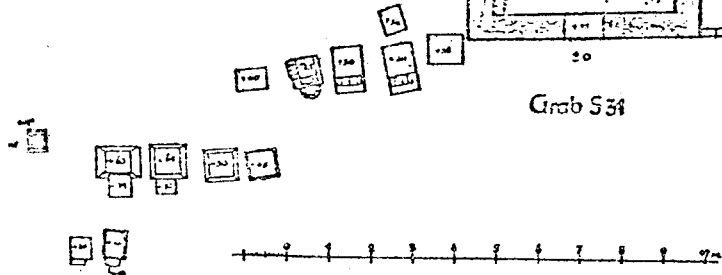
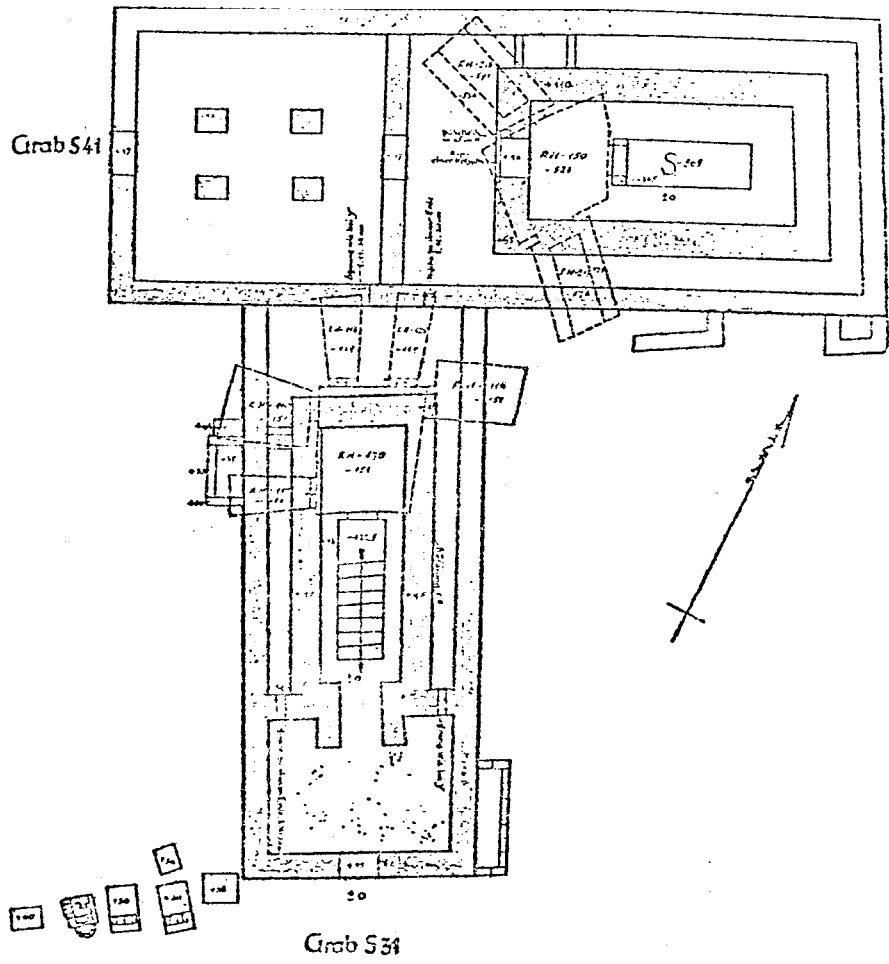

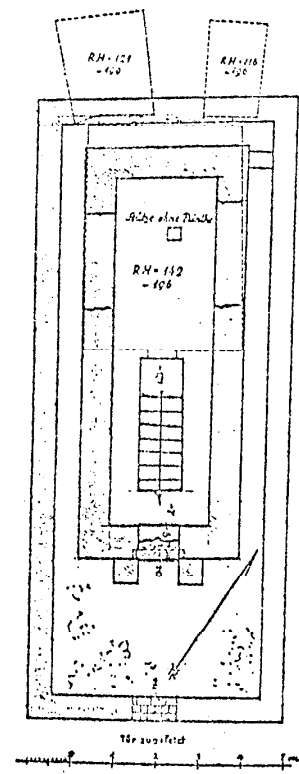

a Grab S64

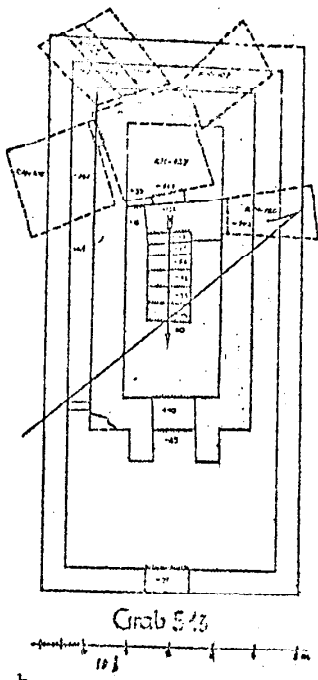

b

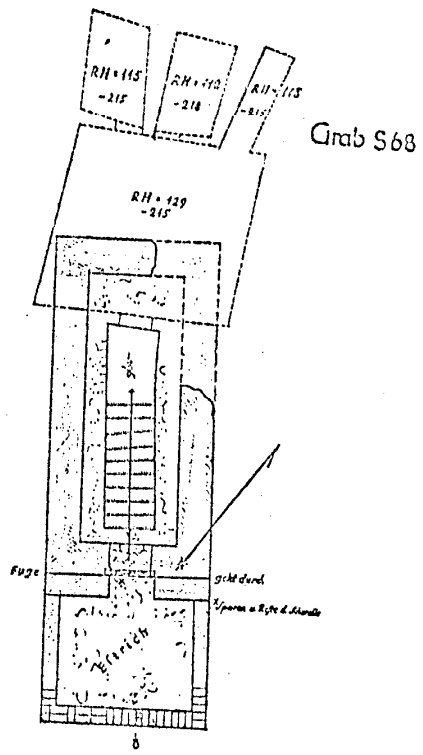

c

Fig. 235.--Aniba: Dromos-Tombs (Cont.)

Steindorff, Aniba: Zweiter Band.

a. S 5 Plan 12

b. S 33 Plan 18

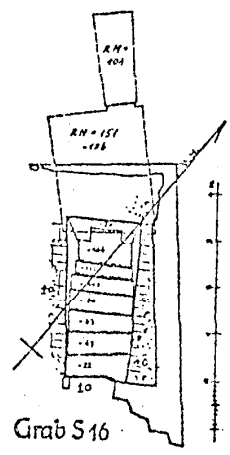
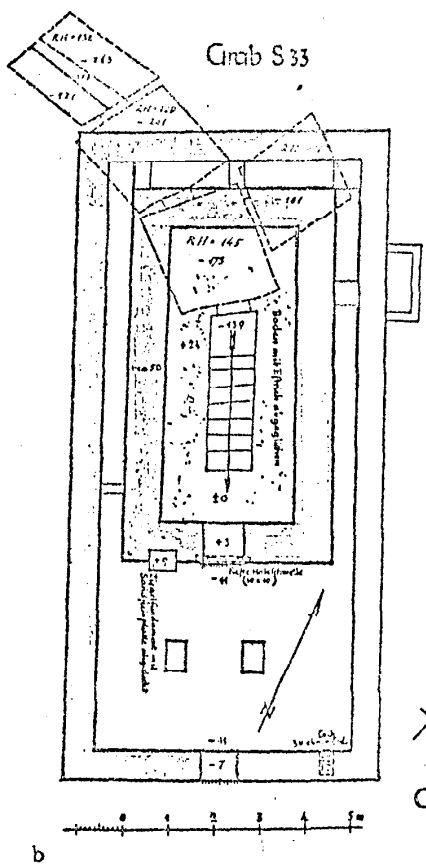
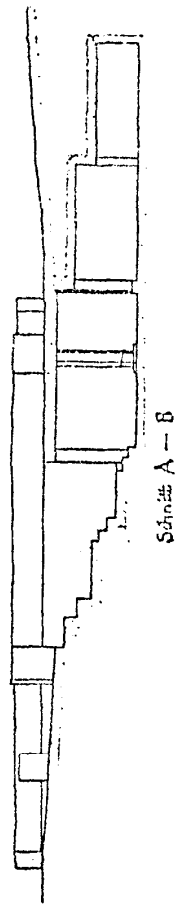
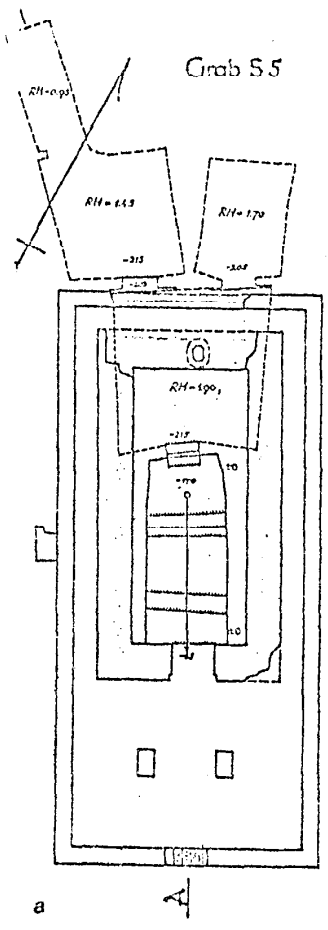

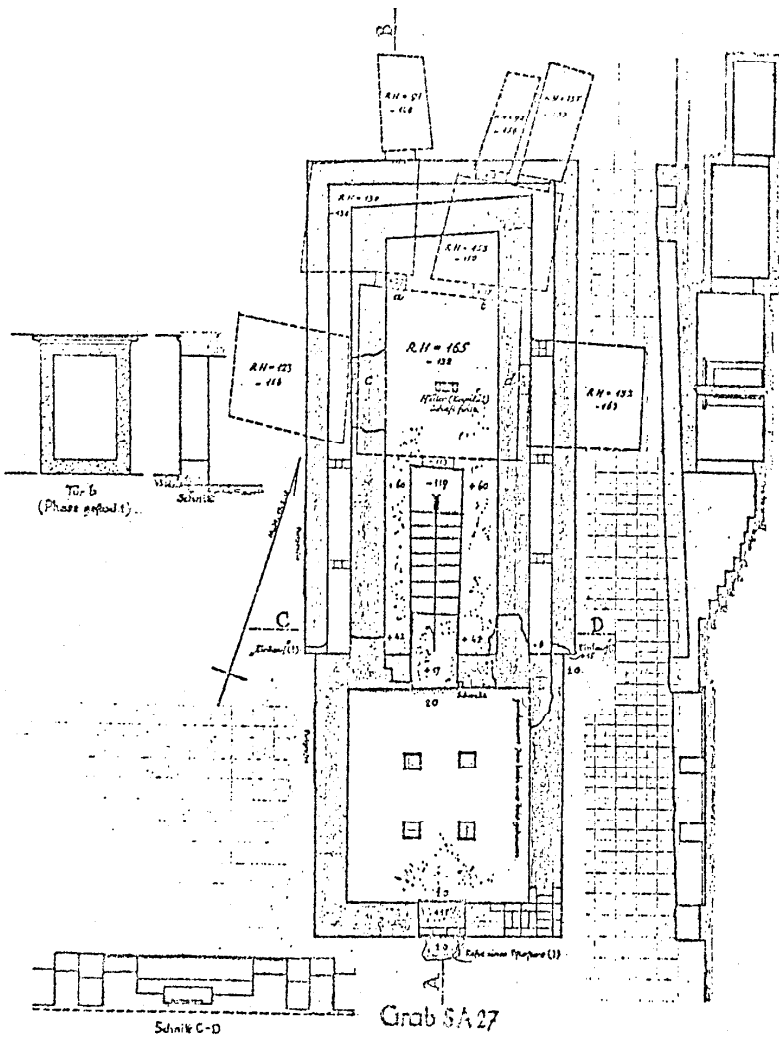

a

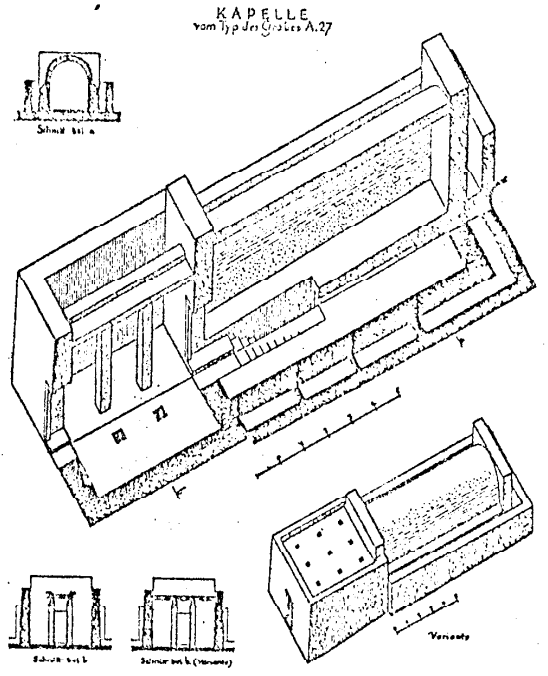
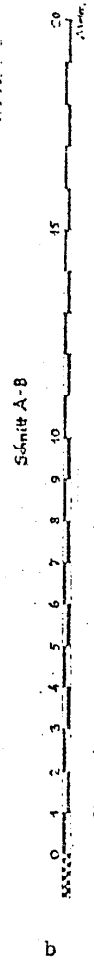

Wiederherstellung des Grabes SA 27

b

Fig. 237.--Aniba: Dromos Tombs (Cont.)

Steindorff, Aniba: Zweiter Band.

a. S 2 Plan 11

b. S 3 Plan 11

c. S12 Plan 13

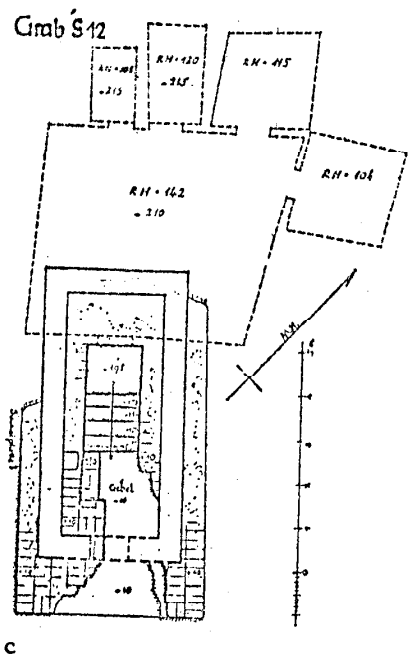
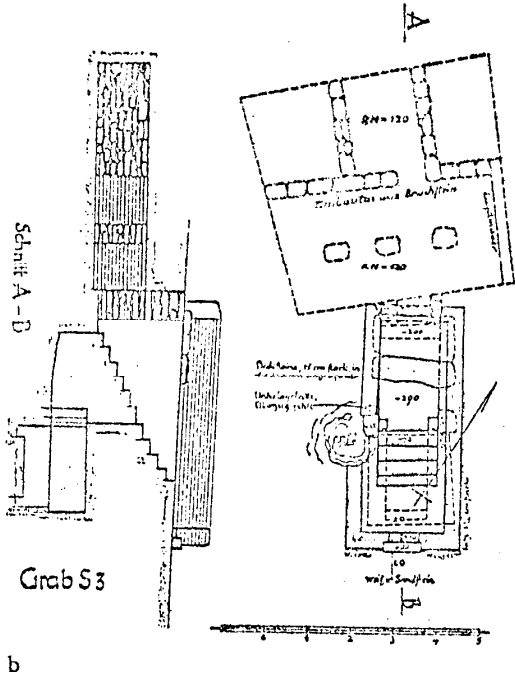
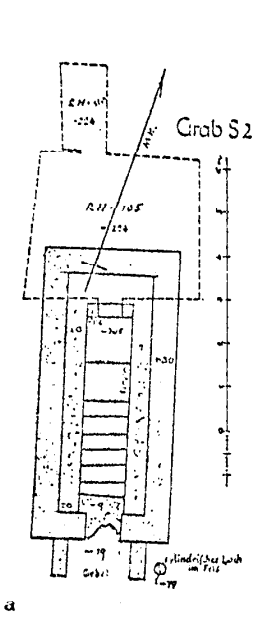

Fig. 238.--Aniba: Shaft Tombs, Set 1 (One Set of Chambers)

Steindorff, Aniba: Zweiter Band.

- a. S 8 Plan 12
- b. S39 Plan 12 (Note pillars or obelisks)
- c. S45 Plan 21
- a. S56 Plan 24

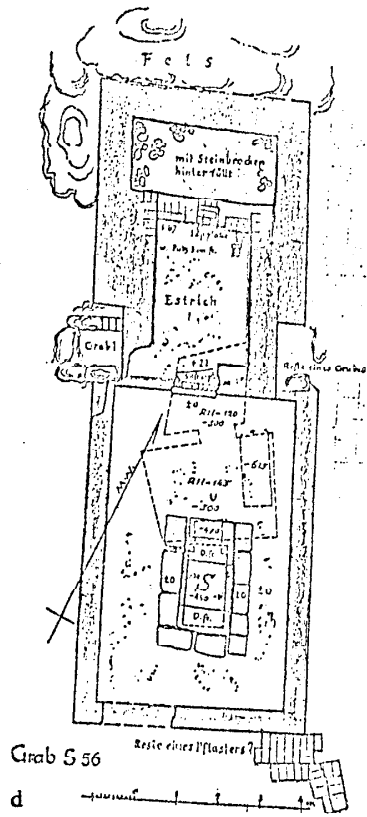
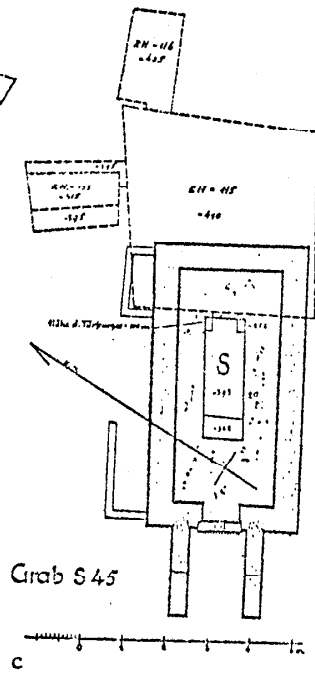
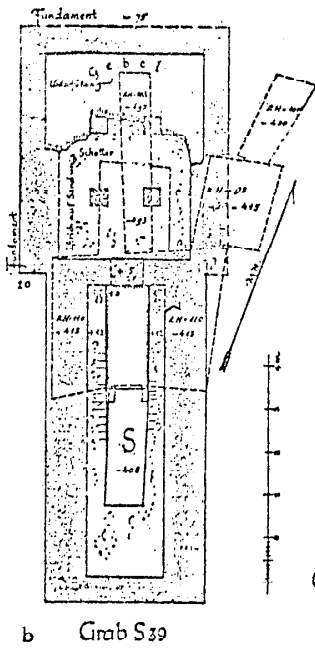
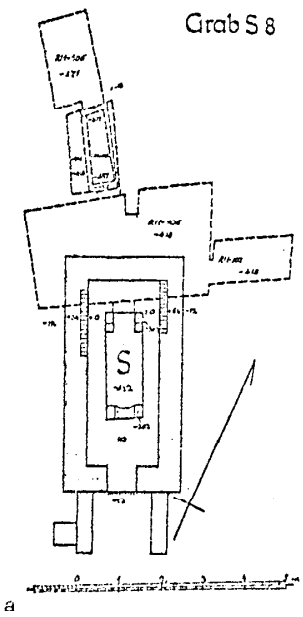

Fig. 239.--Aniba: Shaft Tombs with One Set of Chambers

Steindorff, Aniba: Zweiter Band.

a. S 29 Plan 18

b. S 87 Plan 32

c. S 15 Plan 14

d. S106 Plan 35

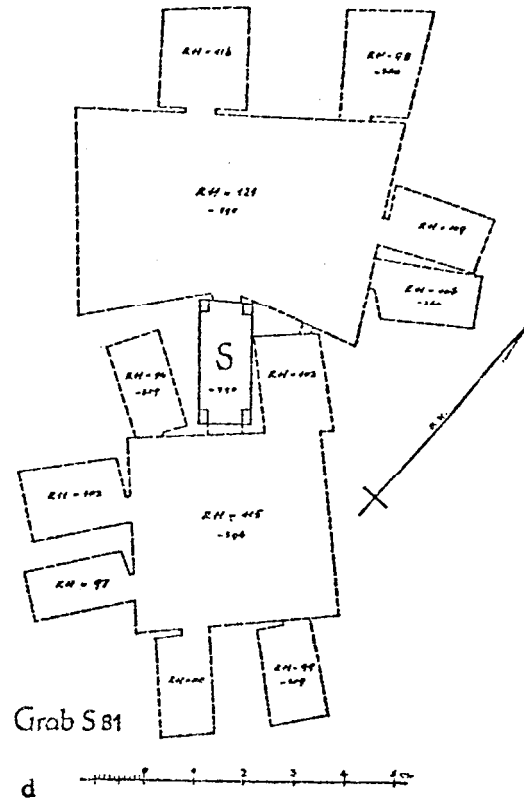
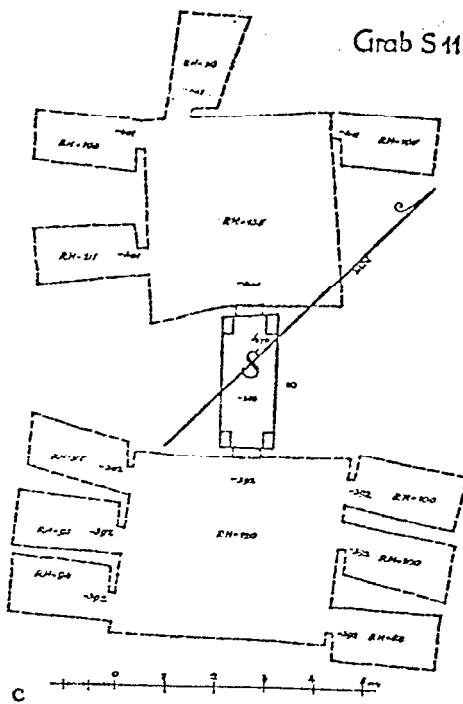
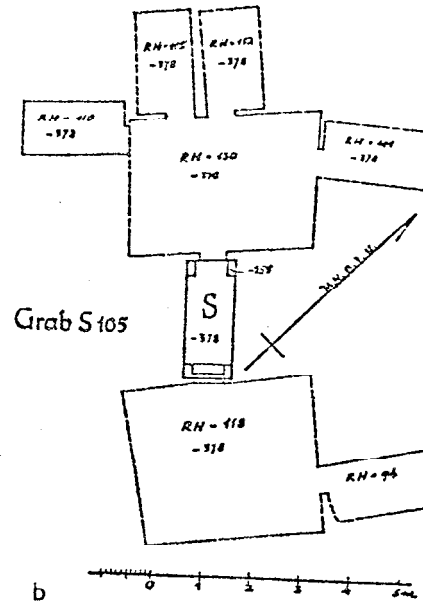
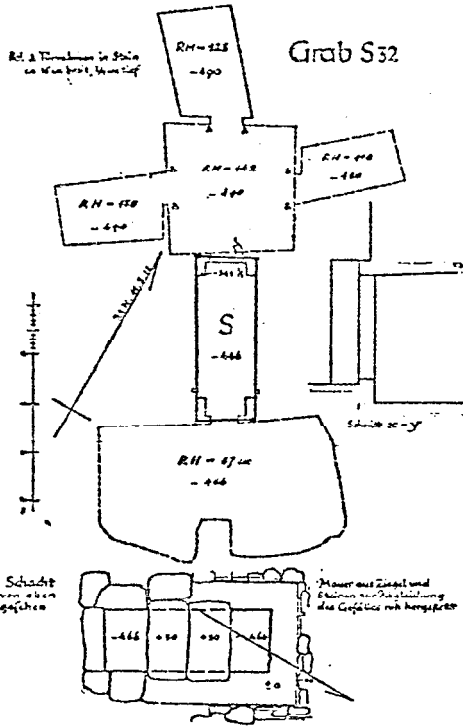

Fig. 240.--Aniba: Shaft Tombs with Two Sets of Chambers

Steindorff, Aniba: Zweiter Band.

a. S 32 Plan 18

b. S105 Plan 35

c. S 11 Plan 13

d. S 81 Plan 31

