

THE UNIVERSITY OF CHICAGO

ARCHAEOLOGY AND HISTORICAL PROBLEMS OF THE
SECOND INTERMEDIATE PERIOD
VOLUME VI

A DISSERTATION SUBMITTED TO
THE FACULTY OF THE DIVISION OF THE HUMANITIES
IN CANDIDACY FOR THE DEGREE OF
DOCTOR OF PHILOSOPHY
DEPARTMENT OF NEAR EASTERN LANGUAGES
AND CIVILIZATIONS

BY
BRUCE WILLIAMS

CHICAGO, ILLINOIS

DECEMBER 1975

Fig. 394.--Jericho: Pottery from Tomb K3 at MB II C Date
Kenyon, Jericho II.

- a. Fig. 93, No. 1
- b. Fig. 93, No. 3
- c. Fig. 93, No. 9
- d. Fig. 93, No. 7
- e. Fig. 93, No. 2
- f. Fig. 93, No. 7
- g. Fig. 93, No. 5
- h. Fig. 93, No. 8
- i. Fig. 93, No. 6
- j. Fig. 93, No. 17
- k. Fig. 93, No. 16
- l. Fig. 93, No. 10
- m. Fig. 93, No. 12

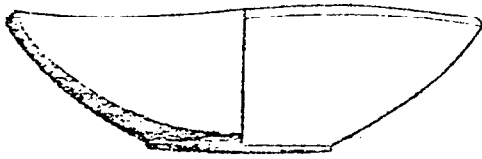

a

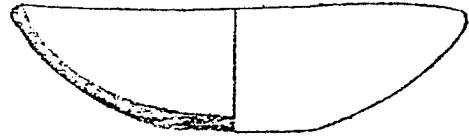

b



c

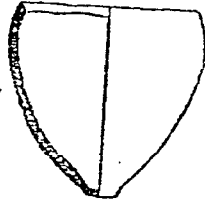

d

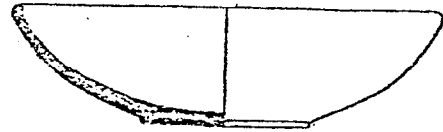

e

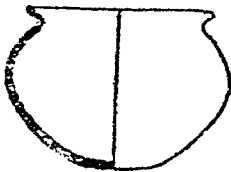

f

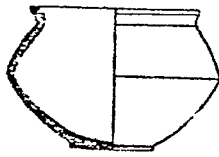

g

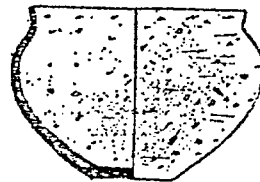

h

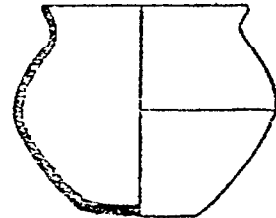

i

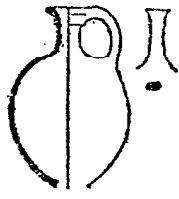

j

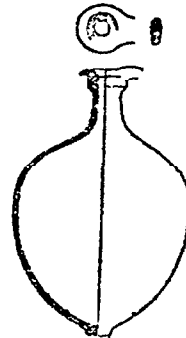

k

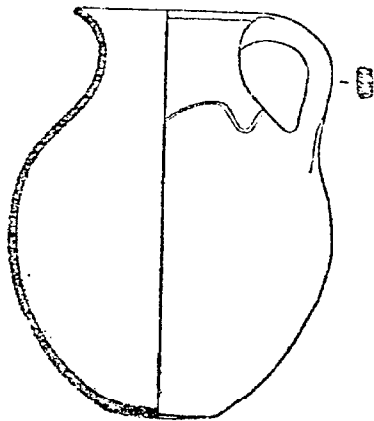

l

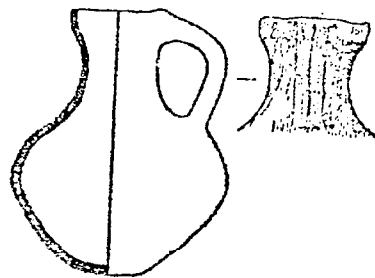

m

Fig. 395.--Jericho: Pottery from Tomb K3 at MB II C Date (Cont.)

Kenyon, Jericho II.

a. Fig. 93, No. 11

b. Fig. 93, No. 14

c. Fig. 93, No. 13

d. Fig. 93, No. 15

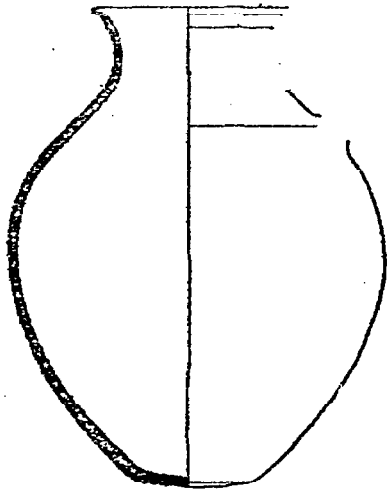

a

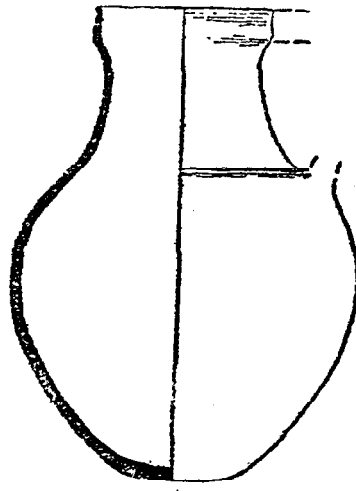

b

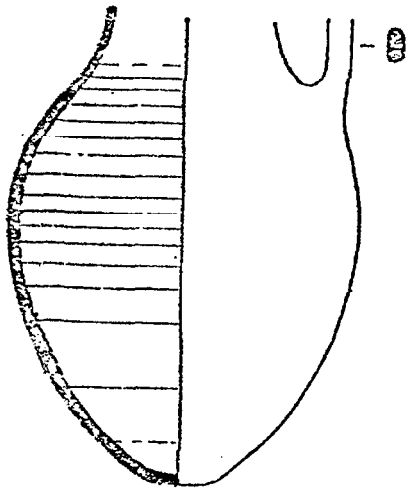

c

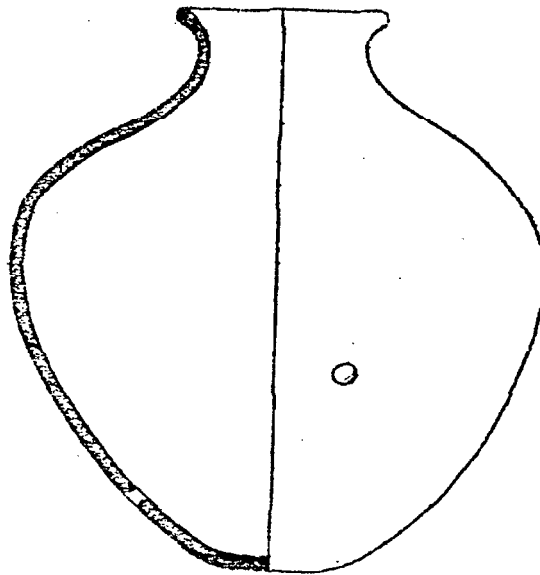

d

Fig. 396.--Jericho: Selected Pottery from Group i

- a. Kenyon, Jericho II, Fig. 95, No. 5
- b. Ibid., No. 2
- c. Kenyon, Jericho I, Fig. 112, No. 2
- d. Kenyon, Jericho II, Fig. 94, No. 4
- e. Ibid., No. 1
- f. Ibid., No. 6
- g. Kenyon, Jericho I, Fig. 115, No. 3
- h. Kenyon, Jericho II, Fig. 95, No. 3
- i. Kenyon, Jericho I, Fig. 115, No. 1
- j. Ibid., Fig. 112, No. 1
- k. Kenyon, Jericho II, Fig. 95, No. 9

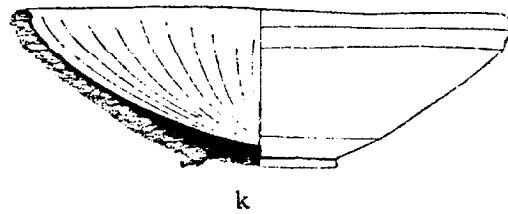
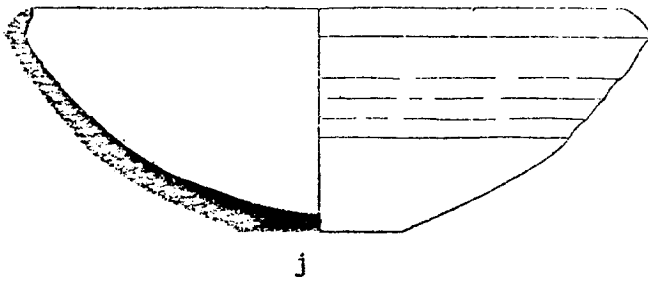
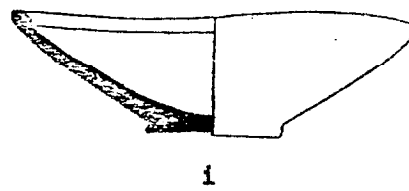
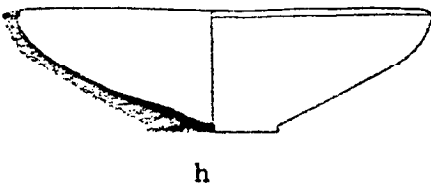
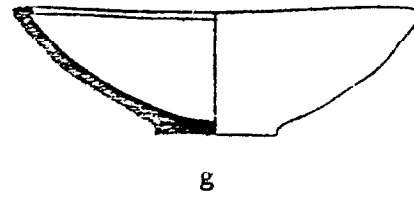
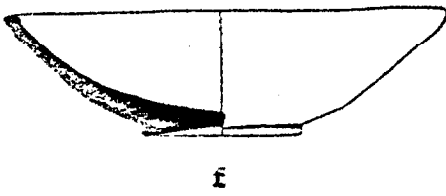
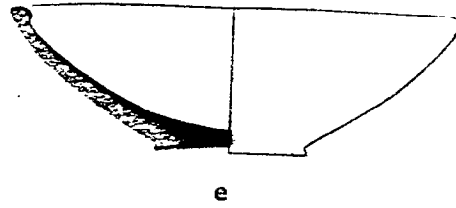
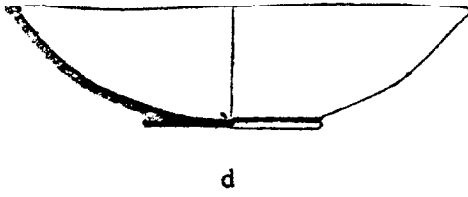
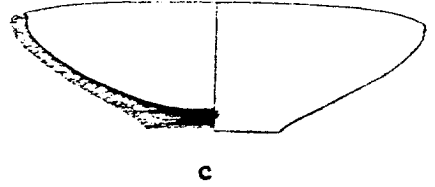
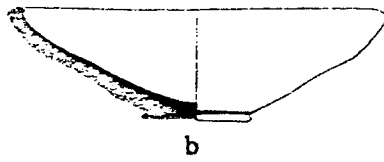
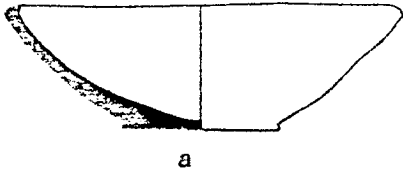

Fig. 397.--Jericho: Selected Pottery from Group i (Cont.)

- a. Kenyon, Jericho I, Fig. 115, No. 6
- b. Ibid., No. 5
- c. Ibid., Fig. 112, No. 5
- d. Kenyon, Jericho II, Fig. 96, No. 4
- e. Ibid., Fig. 95, No. 11
- f. Kenyon, Jericho I, Fig. 112, No. 6
- g. Kenyon, Jericho II, Fig. 96, No. 12
- h. Kenyon, Jericho I, Fig. 112, No. 2
- i. Ibid., Fig. 116, No. 3
- j. Ibid., Fig. 112, No. 11
- k. Kenyon, Jericho II, Fig. 95, No. 19
- l. Ibid., Fig. 96, No. 2

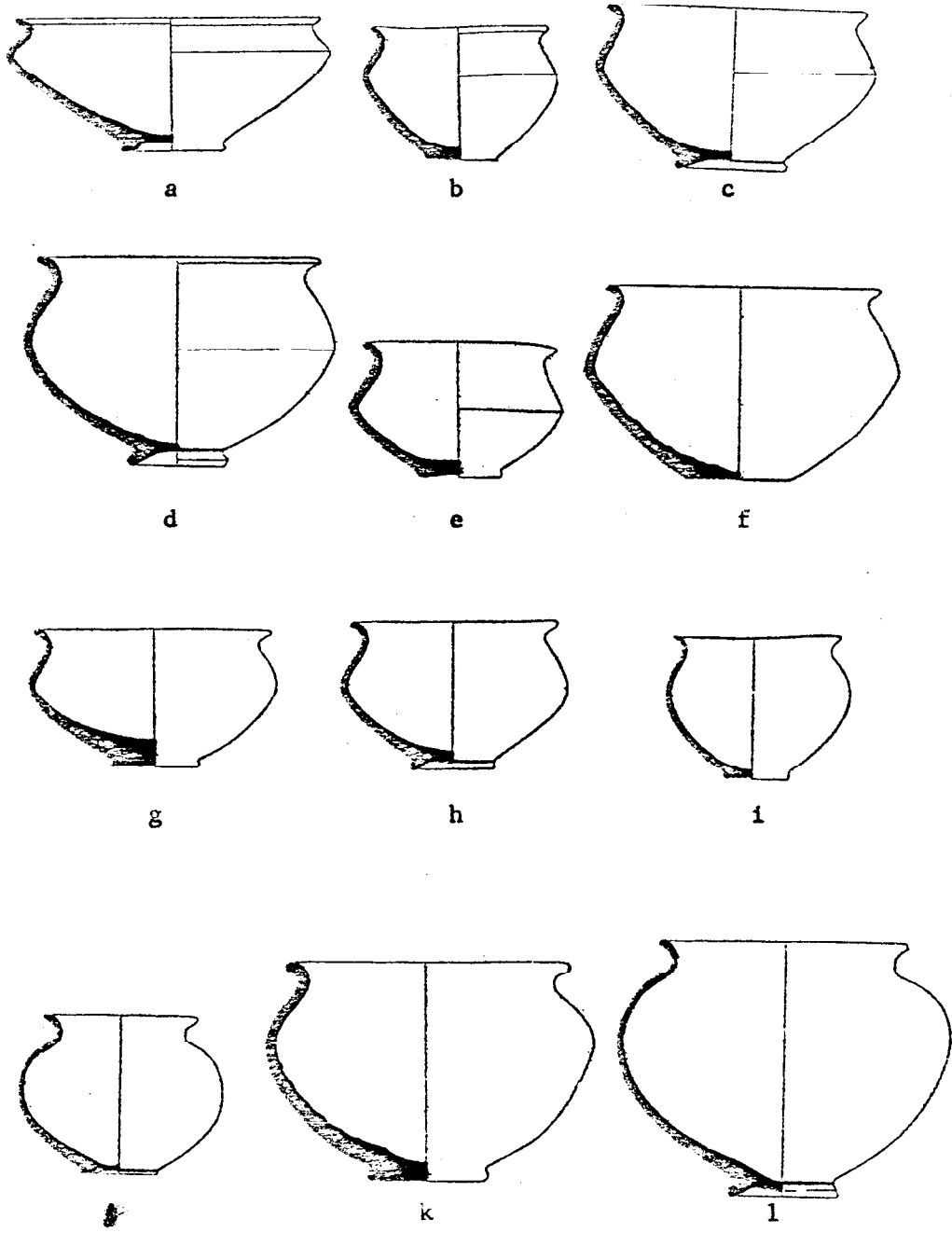
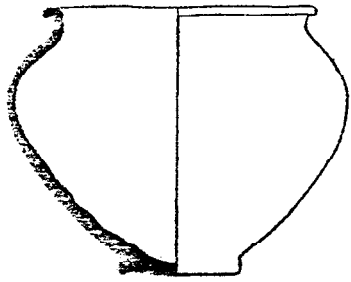
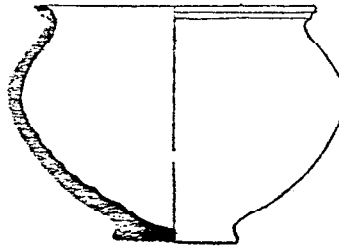

Fig. 398.--Jericho: Selected Pottery from Group i (Cont.)

- a. Kenyon, Jericho I, Fig. 115, No. 7
- b. Ibid., Fig. 112, No. 7
- c. Ibid., Fig. 115, No. 8
- d. Ibid., Fig. 116, No. 5
- e. Ibid., Fig. 112, No. 12
- f. Ibid., Fig. 112, No. 13
- g. Kenyon, Jericho II, Fig. 96, No. 7
- h. Ibid., No. 3
- i. Ibid., No. 4
- j. Ibid., No. 8
- k. Kenyon, Jericho I, Fig. 112, No. 9
- l. Kenyon, Jericho II, Fig. 96, No. 1
- m. Kenyon, Jericho I, Fig. 115, No. 10



a



b

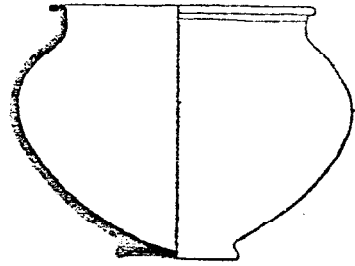

c

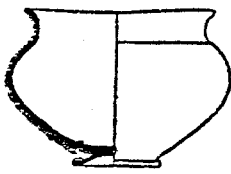

d

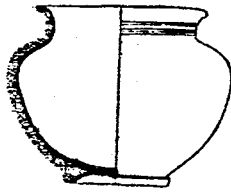

e

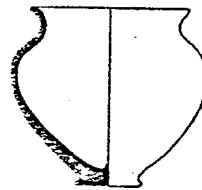

f

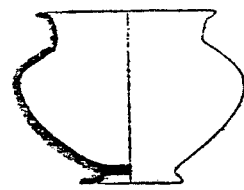

g

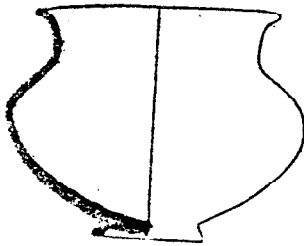

h

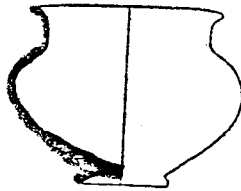

i

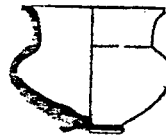

j

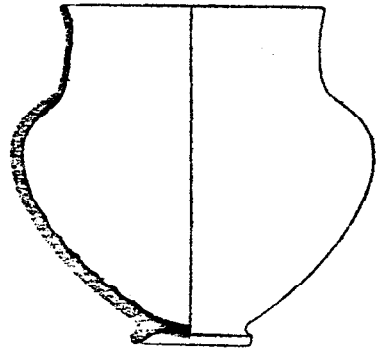

k

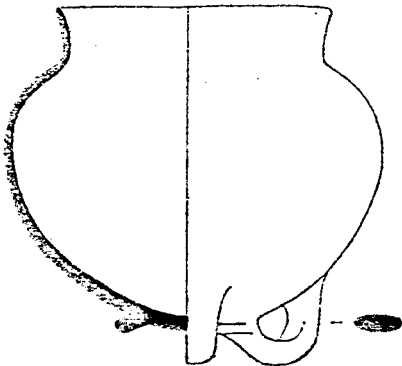

l

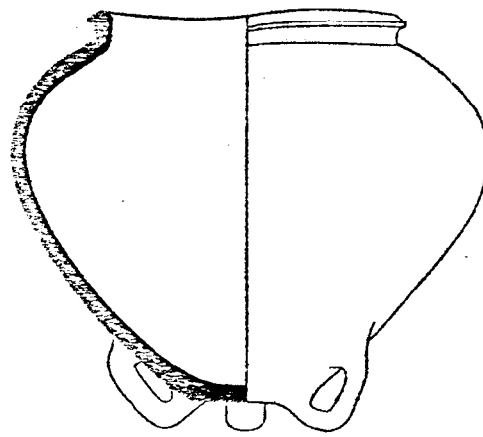

m

Fig. 399.--Jericho: Selected Pottery from Group i (Cont.)

- a. Kenyon, Jericho I, Fig. 113, No. 9
- b. Kenyon, Jericho II, Fig. 97, No. 17
- c. Kenyon, Jericho I, Fig. 113, No. 4
- d. Kenyon, Jericho II, Fig. 98, No. 2
- e. Kenyon, Jericho I, Fig, 113, No. 12
- f. Ibid., No. 6.
- g. Kenyon, Jericho II, Fig. 97, No. 14
- h. Ibid., No. 12
- i. Kenyon, Jericho I, Fig. 113, No. 5
- j. Ibid., No. 8
- k. Kenyon, Jericho II, Fig. 97, No. 11
- l. Kenyon, Jericho I, Fig. 116, No. 11
- m. Kenyon, Jericho II, Fig. 97, No. 9
- n. Kenyon, Jericho I, Fig. 116, No. 10
- o. Kenyon, Jericho II, Fig. 97, No. 8
- p. Ibid., No. 7
- q. Ibid., No. 4
- r. Ibid., No. 6
- s. Ibid., No. 5
- t. Ibid., Fig. 98, No. 9
- u. Kenyon, Jericho I, Fig. 113, No. 11

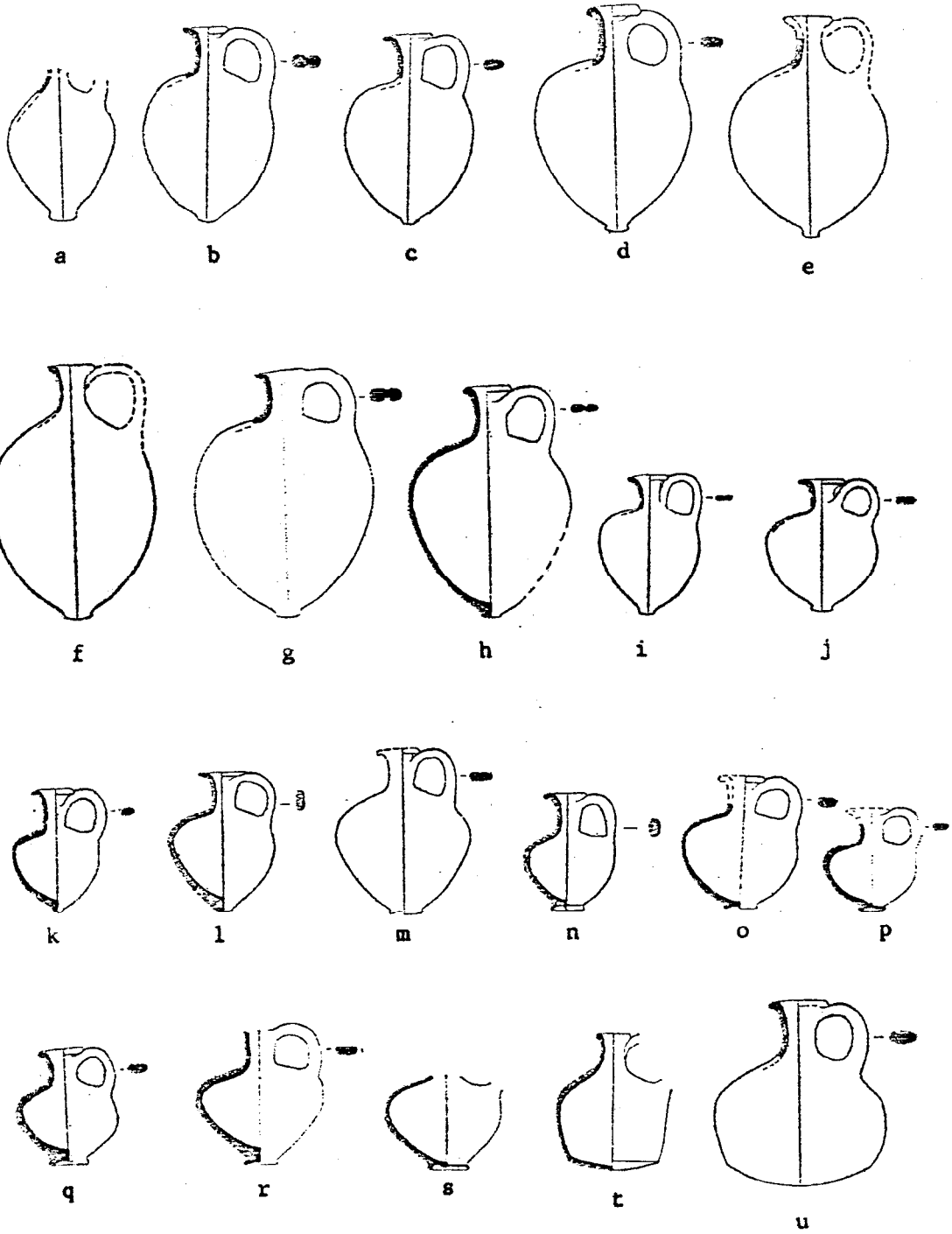

Fig. 400.--Jericho: Selected Pottery from Group i (Cont.)

- a. Kenyon, Jericho I, Fig. 116, No. 8
- b. Ibid., Fig. 112, No. 17
- c. Ibid., Fig. 117, No. 1
- d. Kenyon, Jericho II, Fig. 97, No. 3
- e. Kenyon, Jericho I, Fig. 113, No. 12
- f. Kenyon, Jericho II, Fig. 99, No. 2

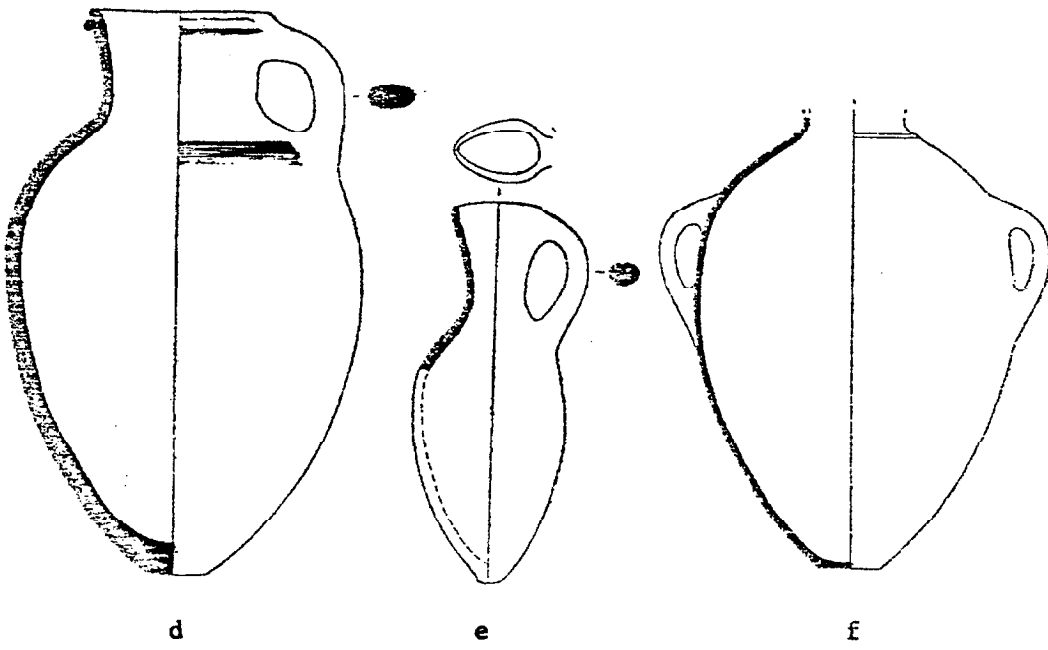
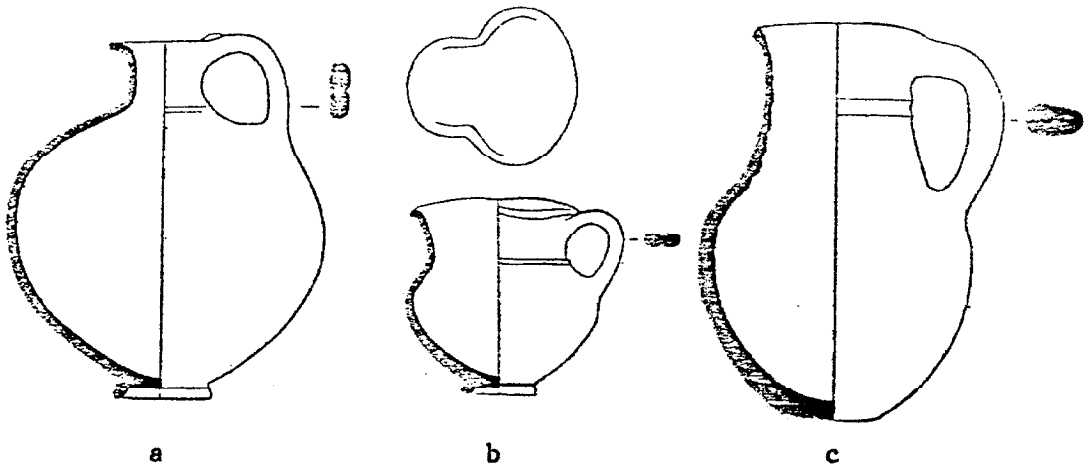

Fig. 401.--Jericho: Selected Pottery from Group i (Cont.)

- a. Kenyon, Jericho I, Fig. 116, No. 7
- b. Ibid., Fig. 113, No. 13
- c. Ibid., Fig. 116, No. 6
- d. Ibid., Fig. 116, 12
- e. Kenyon, Jericho II, Fig. 100, No. 2
- f. Ibid., No. 2
- g. Kenyon, Jericho I, Fig. 118, No. 1
- h. Ibid., No. 2

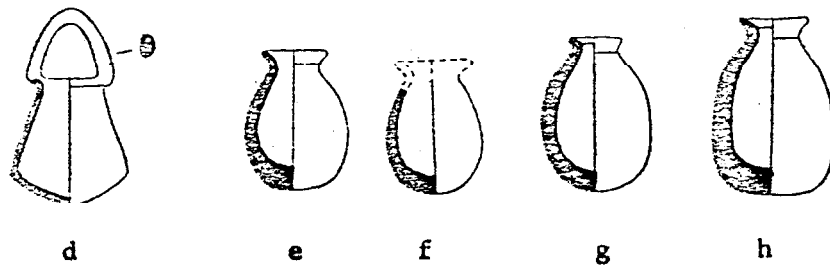
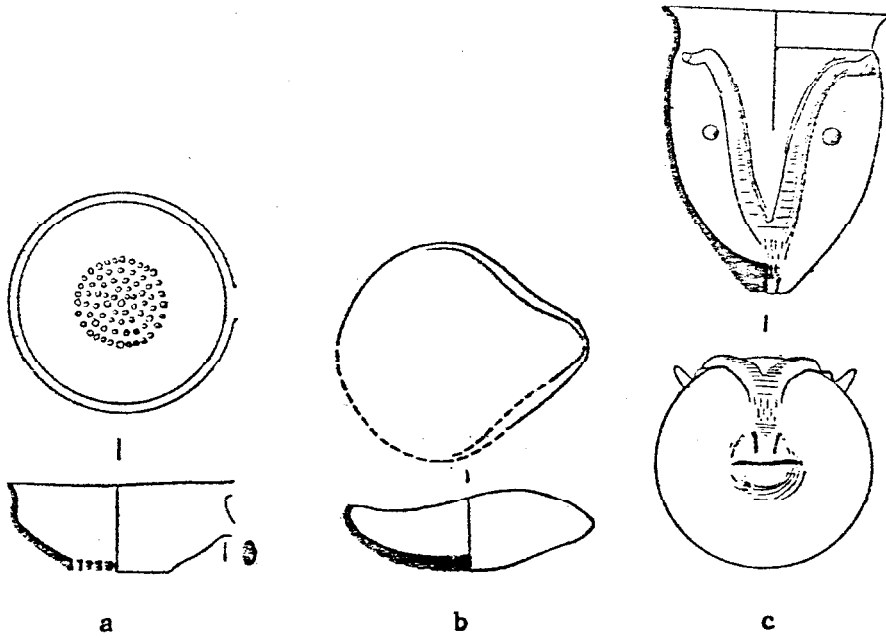
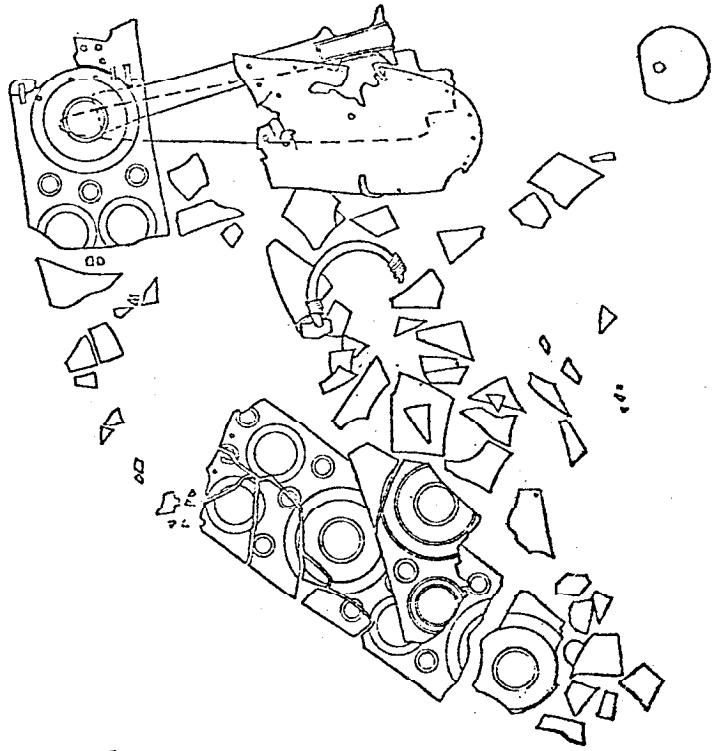
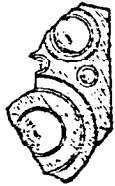
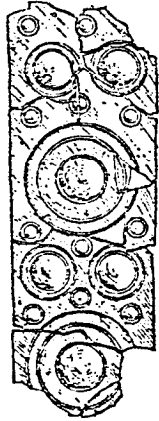
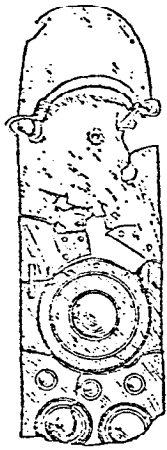
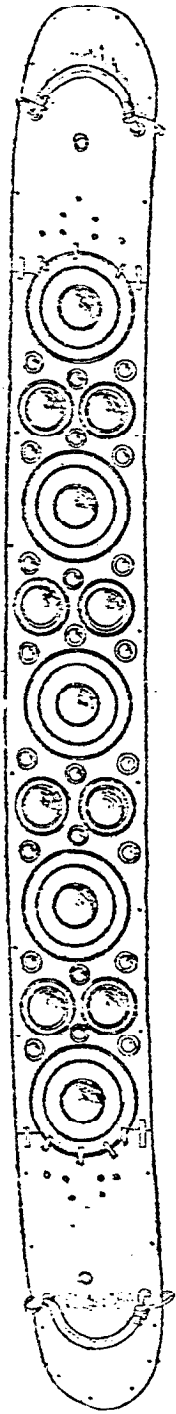

Fig. 402.--Jericho: Metal Objects from Group i

Kenyon, Jericho I.

- a. Fig. 117, No. 1
- b. Fig. 117, No. 6 Axe
- c. Fig. 117, No. 2
- d. Fig. 117, No. 3 Bands
- e. Fig. 117, No. 5 Dagger



a

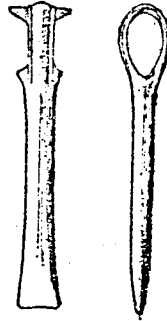

b



c



d

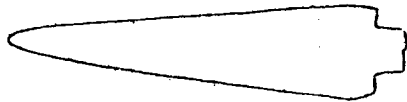

e



Fig. 403.--Jericho: Selected Pottery from Group ii Early, Tomb D22

Kenyon, Jericho II, Fig.116.

a. No. 9

b. No. 10

c. No. 1

d. No. 5

e. No. 8

f. No. 20

g. No. 24

h. No. 25

i. No. 22

j. No. 15

k. No. 18

l. No. 19

m. No. 26

n. No. 27

o. No. 28

p. No. 12

q. No. 14

r. No. 4

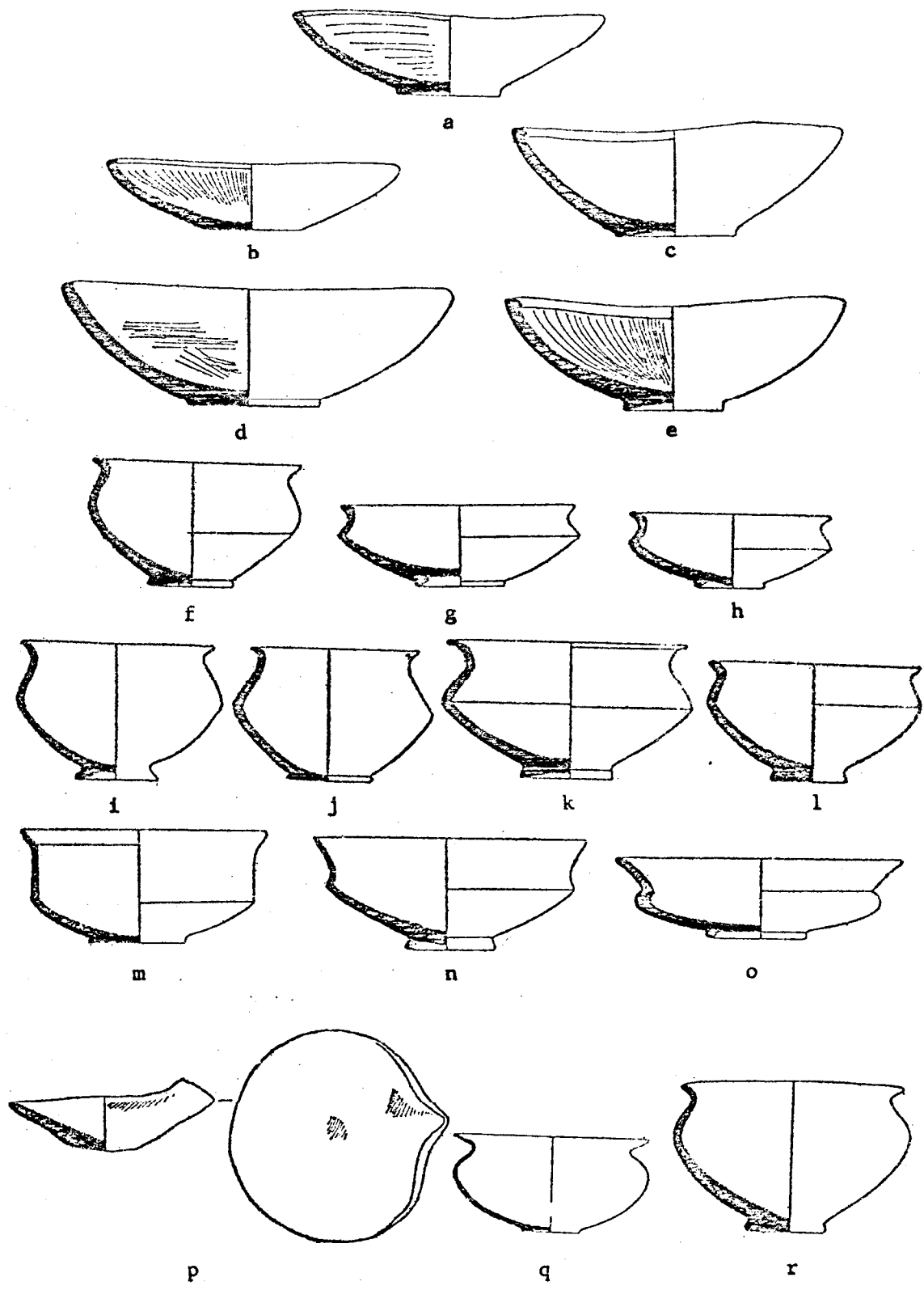

Fig. 404.--Jericho: Selected Pottery from Group ii Early, Tomb D22
(Cont.)

Kenyon, Jericho II.

Fig. 120:

- a. No. 10
- b. No. 1
- c. No. 4
- d. No. 6
- e. No. 5
- f. No. 8
- g. No. 15
- h. No. 14
- i. No. 21
- j. No. 13
- k. No. 20

Fig. 121:

- l. No. 8
- m. No. 5
- n. No. 6
- o. No. 3

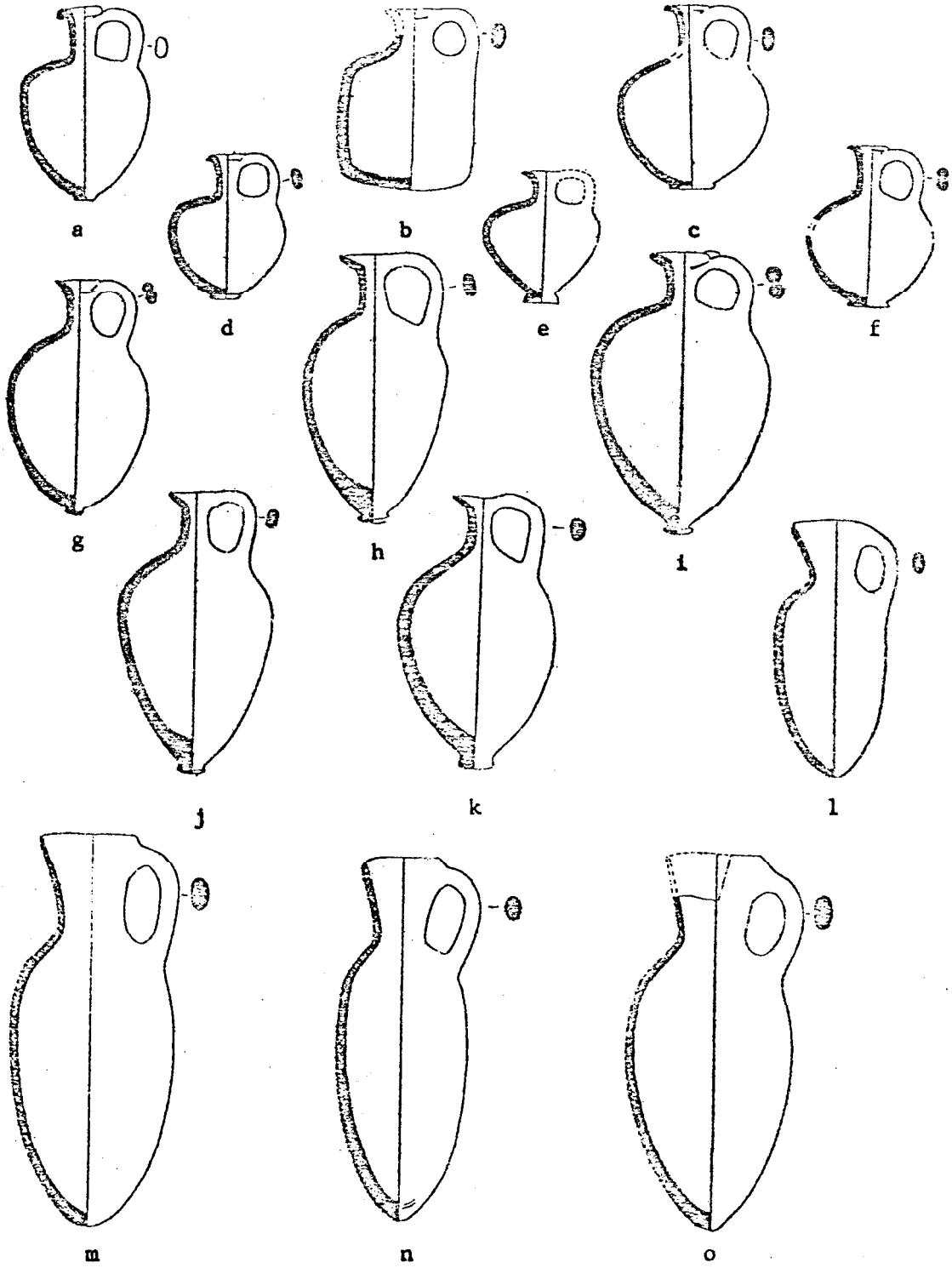

(Cont.) Fig. 405.--Jericho: Selected Pottery from Group ii Early, Tomb D22

Kenyon, Jericho II.

- a. Fig. 119, No. 11
- b. Fig. 119, No. 15
- c. Fig. 118, No. 11
- d. Fig. 119, No. 17
- e. Fig. 118, No. 13
- f. Fig. 118, No. 4
- g. Fig. 118, No. 6
- h. Fig. 119, No. 1
- i. Fig. 119, No. 3
- j. Fig. 117, No. 3
- k. Fig. 118, No. 1

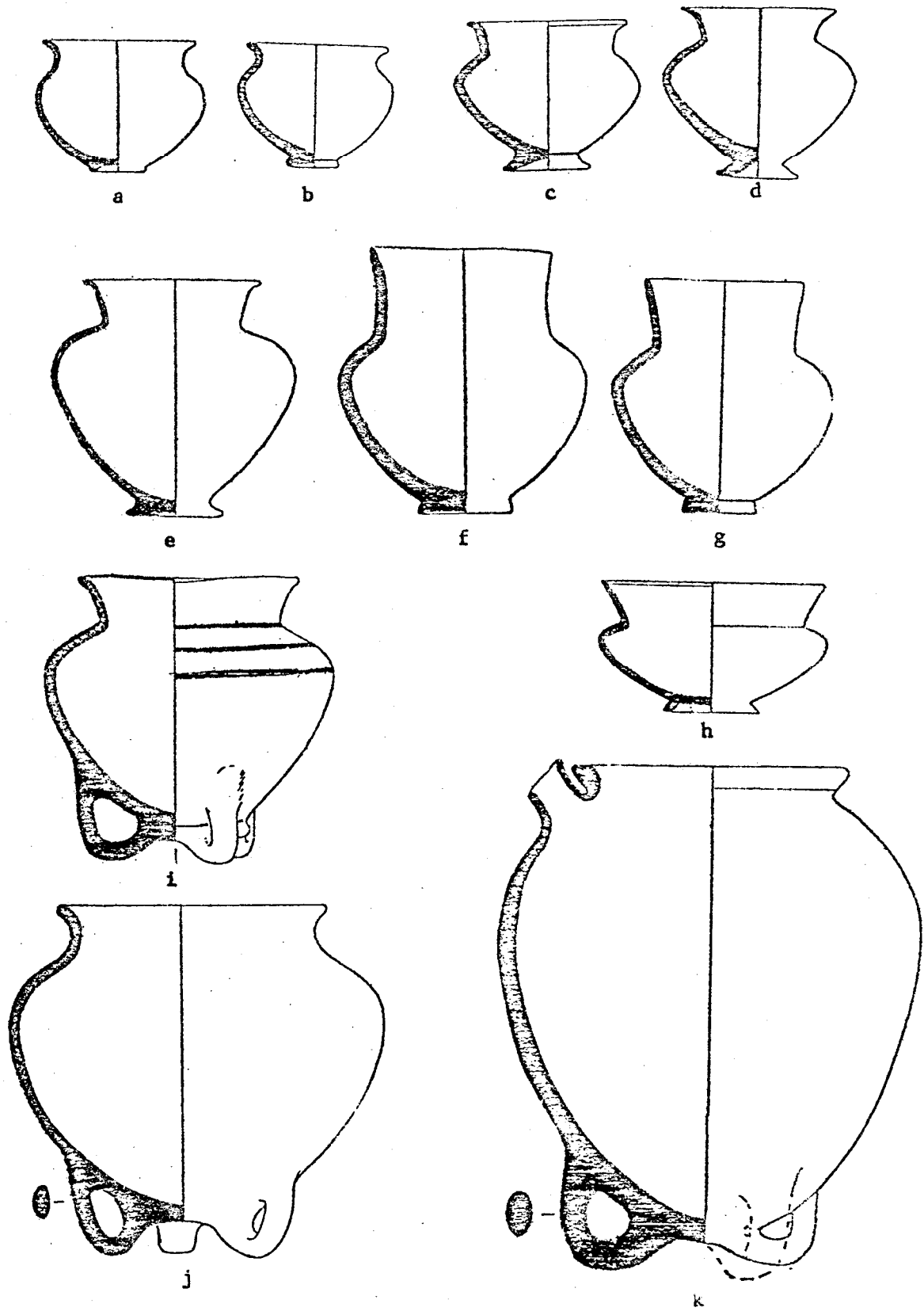

(Cont.) Fig. 406.--Jericho: Selected Pottery from Group ii Early, Tomb D22

Kenyon, Jericho II.

a. Fig. 122, No. 1

b. Fig. 120, No. 3

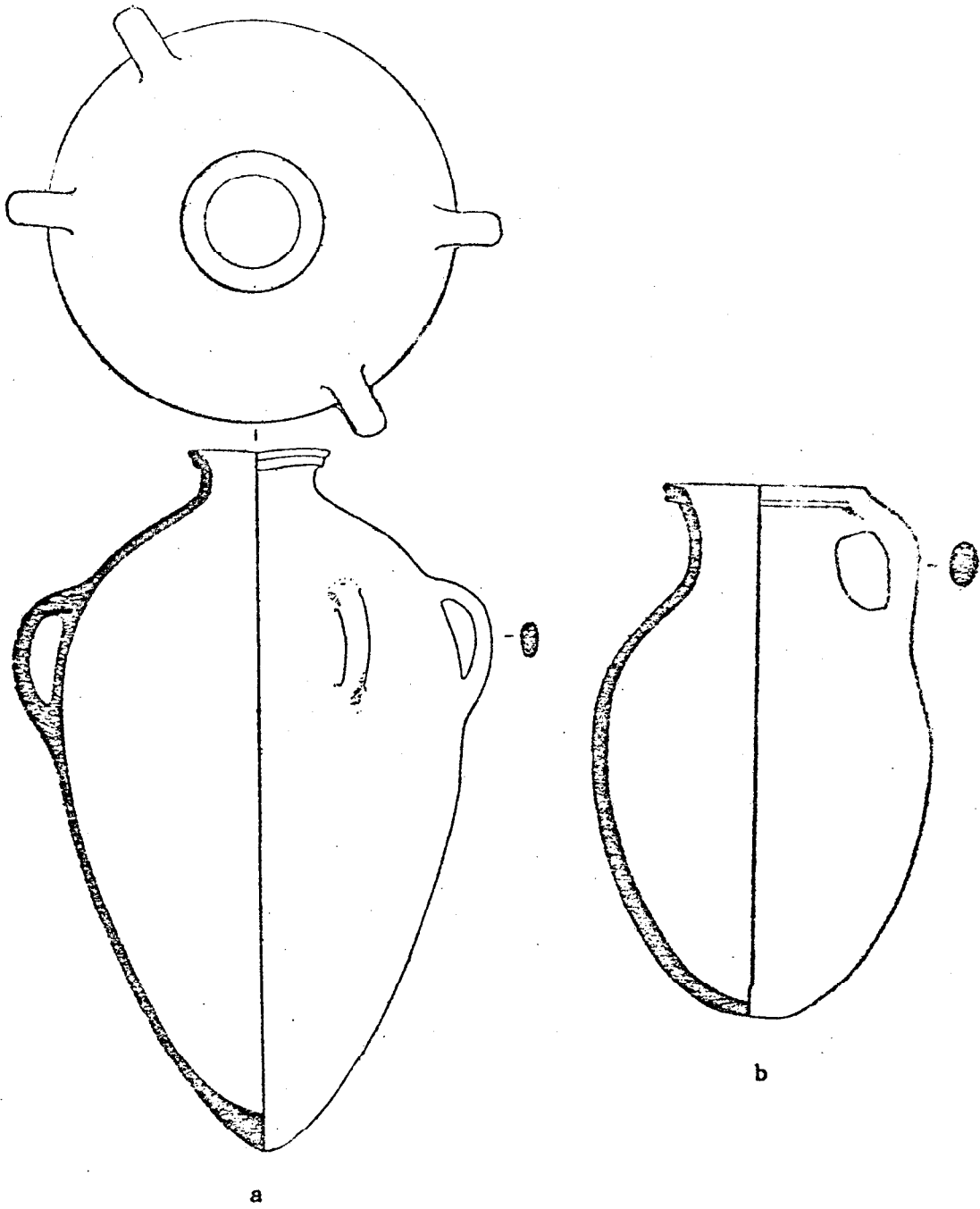

Fig. 407.--Jericho: Selected Pottery from Tomb B48, Second Stage:
Group ii Mid to Late

Kenyon, Jericho II.

- a. Fig. 95, No. 10
- b. Fig. 95, No. 14
- c. Fig. 95, No. 7
- d. Fig. 96, No. 11
- e. Fig. 95, No. 13
- f. Fig. 95, No. 12
- g. Fig. 95, No. 16
- h. Fig. 95, No. 15
- i. Fig. 96, No. 10
- j. Fig. 95, No. 18
- k. Fig. 95, No. 17
- l. Fig. 96, No. 13
- m. Fig. 96, No. 19
- n. Fig. 96, No. 18
- o. Fig. 96, No. 14
- p. Fig. 96, No. 17
- q. Fig. 96, No. 16

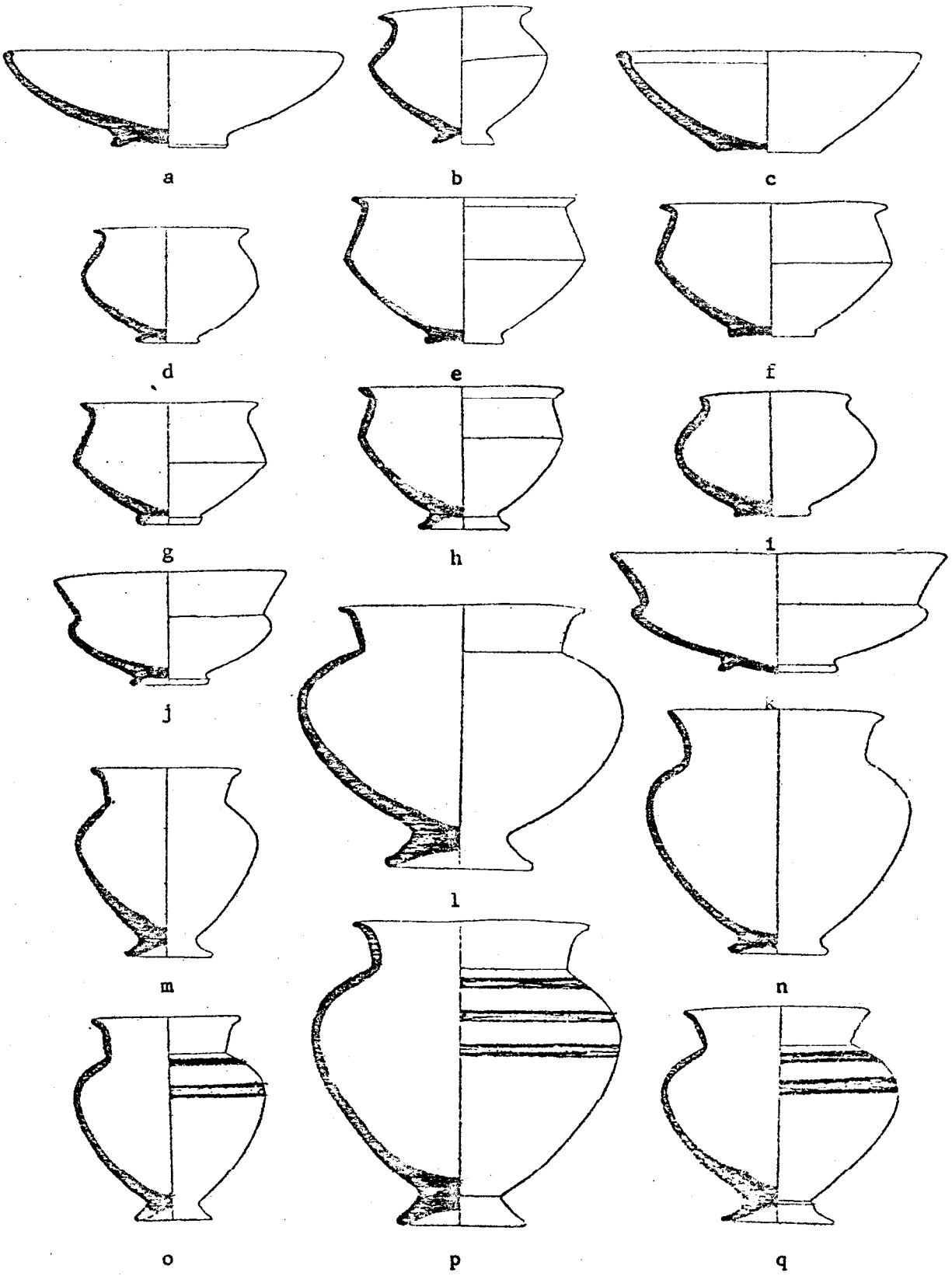

Fig. 408.--Jericho: Selected Pottery from Tomb B48, Second Stage:
Group ii Mid to Late (Cont.)

Kenyon, Jericho II.

- a. Fig. 97, No. 10
- b. Fig. 98, No. 4
- c. Fig. 98, No. 1
- d. Fig. 98, No. 5
- e. Fig. 97, No. 16
- f. Fig. 98, No. 3
- g. Fig. 98, No. 10
- h. Fig. 98, No. 12
- i. Fig. 97, No. 1
- j. Fig. 95, No. 20
- k. Fig. 97, No. 2

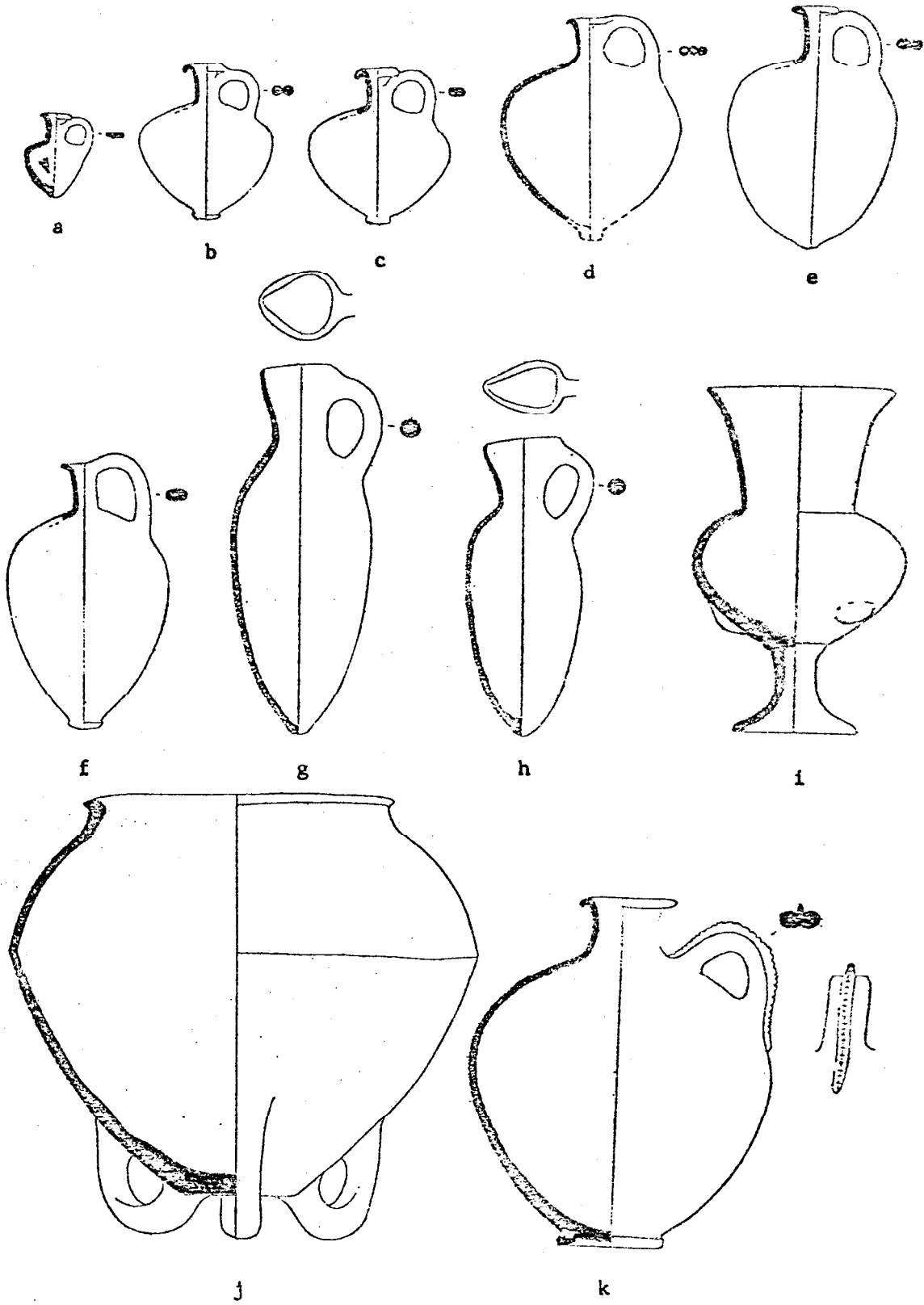
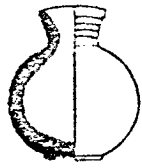

Fig. 409.--Jericho: Selected Pottery and Stone Vessels from Tomb
B48, Second Stage: Group ii Mid to Late

Kenyon, Jericho II.

- a. Fig. 100, No. 4
- b. Fig. 100, No. 3
- c. Fig. 99, No. 1



a



b

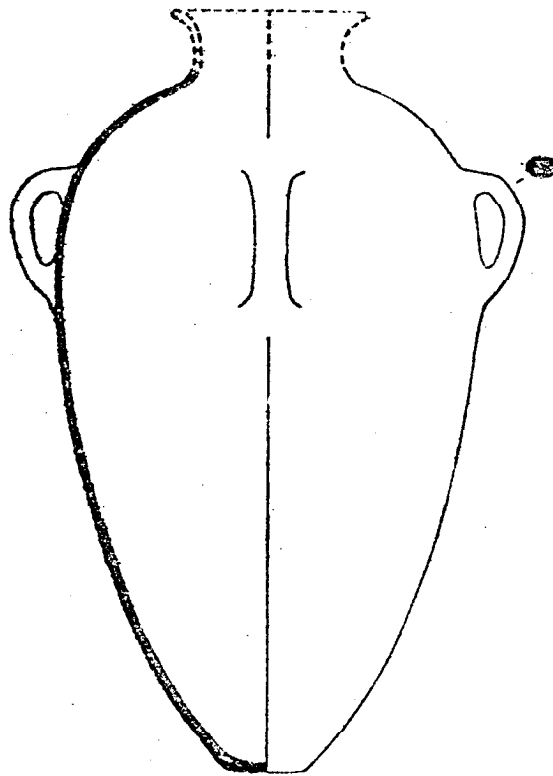

c

Fig. 410.--Jericho: Selected Pottery from Group ii Middle

Kenyon, Jericho II.

- a. Fig. 147, No. 1
- b. Fig. 133, No. 4
- c. Fig. 133, No. 2
- d. Fig. 133, No. 1
- e. Fig. 133, No. 6
- f. Fig. 133, No. 9
- g. Fig. 133, No. 11
- h. Fig. 133, No. 10
- i. Fig. 131, No. 1
- j. Fig. 133, No. 5
- k. Fig. 147, No. 3



a

b

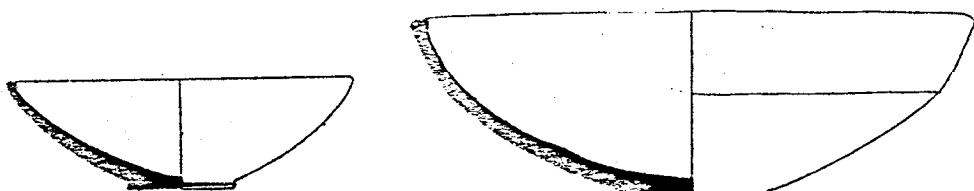

c

d

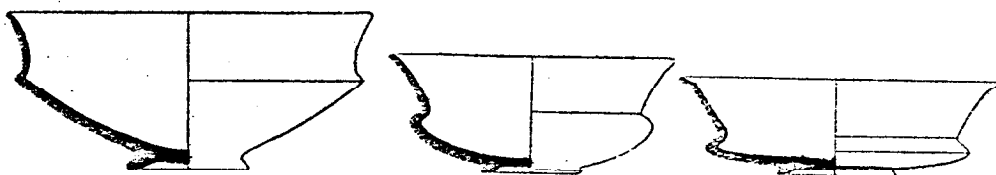

e

f

g

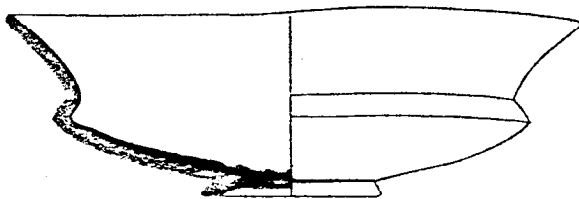

h

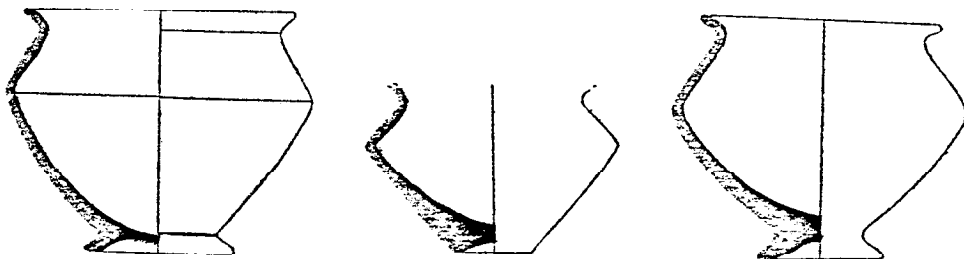

i

j

k

Fig. 411.--Jericho: Selected Pottery from Group ii Middle (Cont.)

Kenyon, Jericho II.

- a. Fig. 147, No. 2
- b. Fig. 147, No. 6
- c. Fig. 134, No. 10
- d. Fig. 134, No. 9
- e. Fig. 147, No. 10
- f. Fig. 134, No. 8
- g. Fig. 131, No. 4
- h. Fig. 147, No. 9
- i. Fig. 133, No. 12
- j. Fig. 134, No. 3
- k. Fig. 134, No. 1

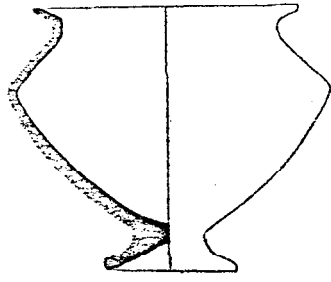

a

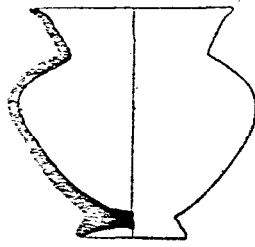

b

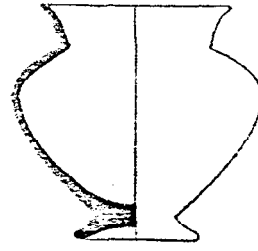

c

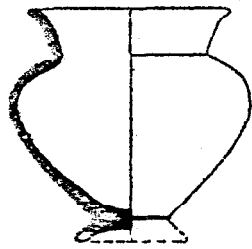

d

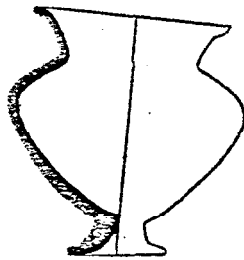

e

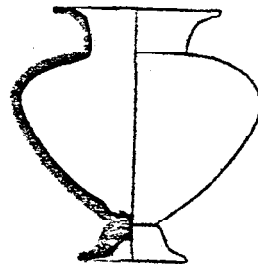

f

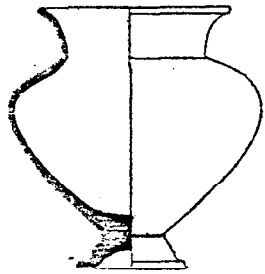

g

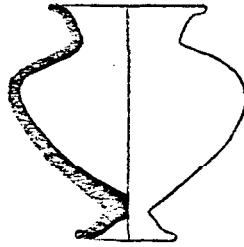

h

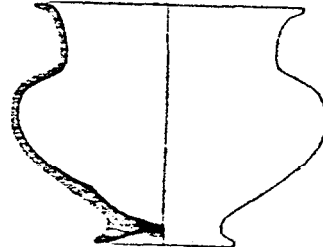

i

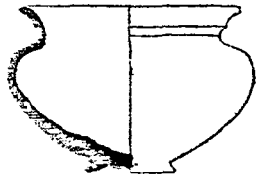

j

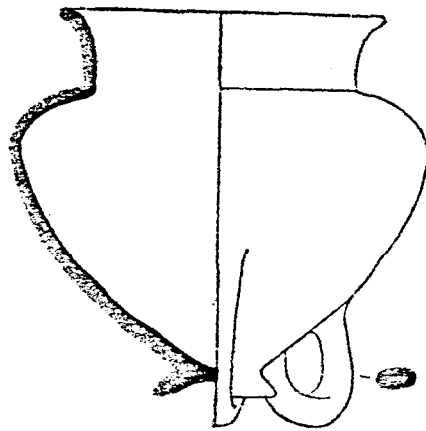

k

Fig. 412.--Jericho: Selected Pottery from Group ii Middle (Cont
Kenyon, Jericho II.

- a. Fig. 131, No. 8
- b. Fig. 147, No. 15
- c. Fig. 147, No. 16
- d. Fig. 134, No. 19
- e. Fig. 131, No. 5
- f. Fig. 134, No. 11
- g. Fig. 134, No. 14
- h. Fig. 134, No. 20
- i. Fig. 131, No. 7
- j. Fig. 147, No. 18
- k. Fig. 134, No. 16
- l. Fig. 136, No. 1

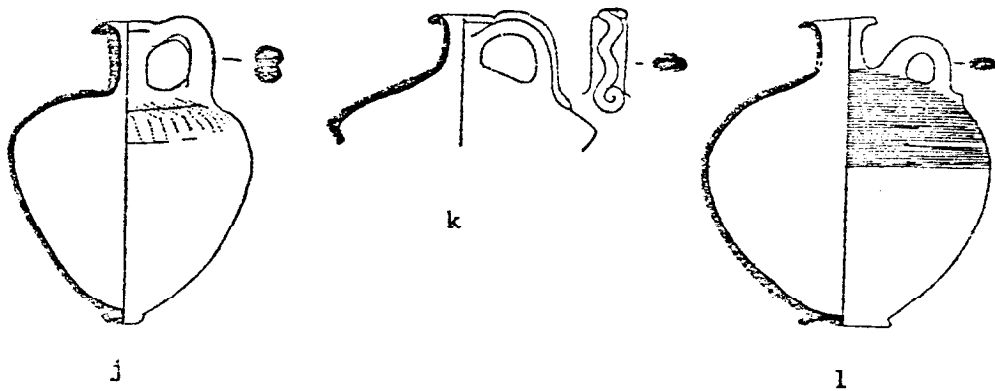
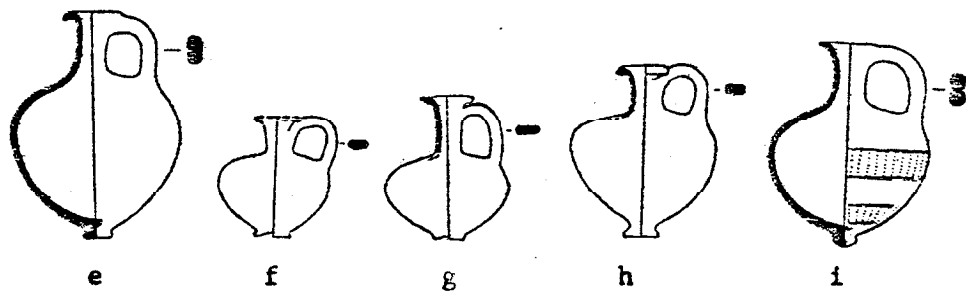
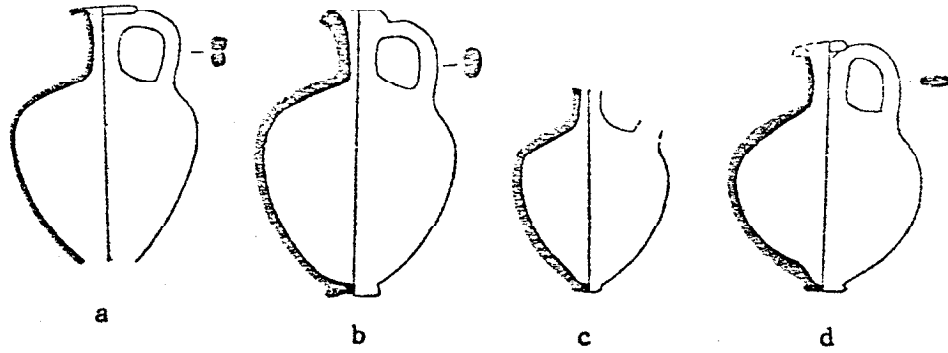

Fig. 413.--Jericho: Selected Pottery from Group ii Middle (Cont.)

Kenyon, Jericho II.

- a. Fig. 135, No. 4
- b. Fig. 135, No. 3
- c. Fig. 148, No. 6
- d. Fig. 148, No. 2
- e. Fig. 148, No. 3
- f. Fig. 149, No. 3
- g. Fig. 135, No. 1

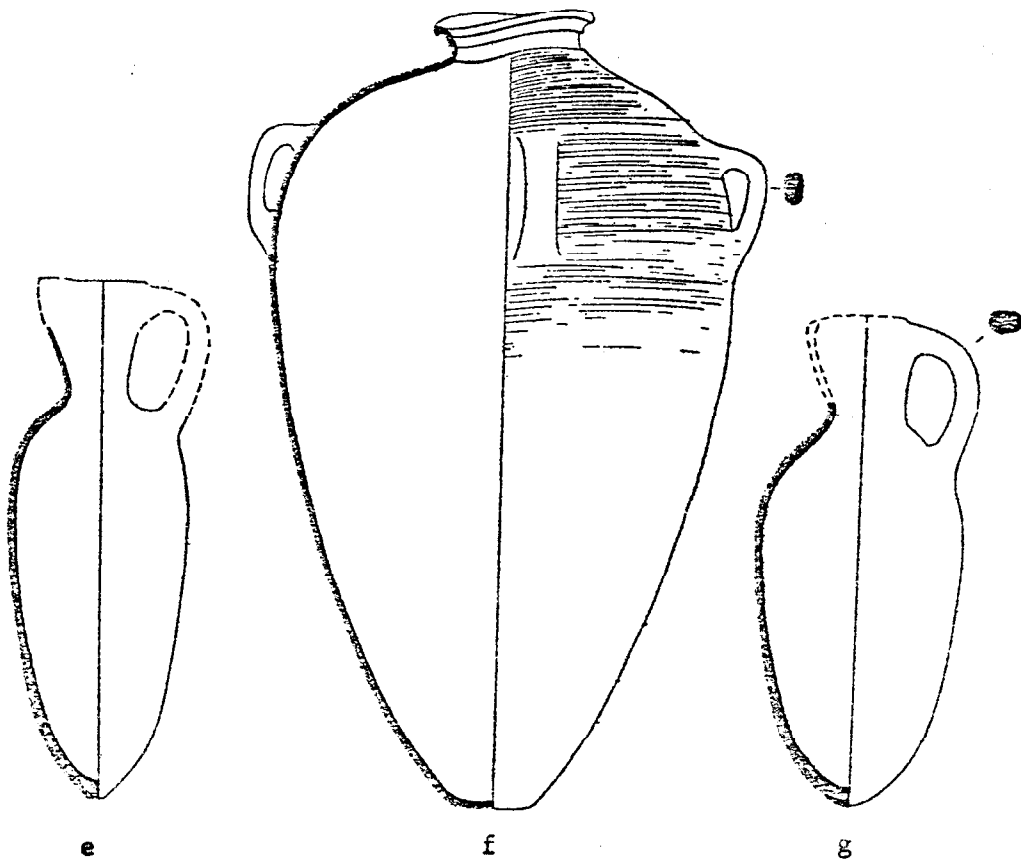
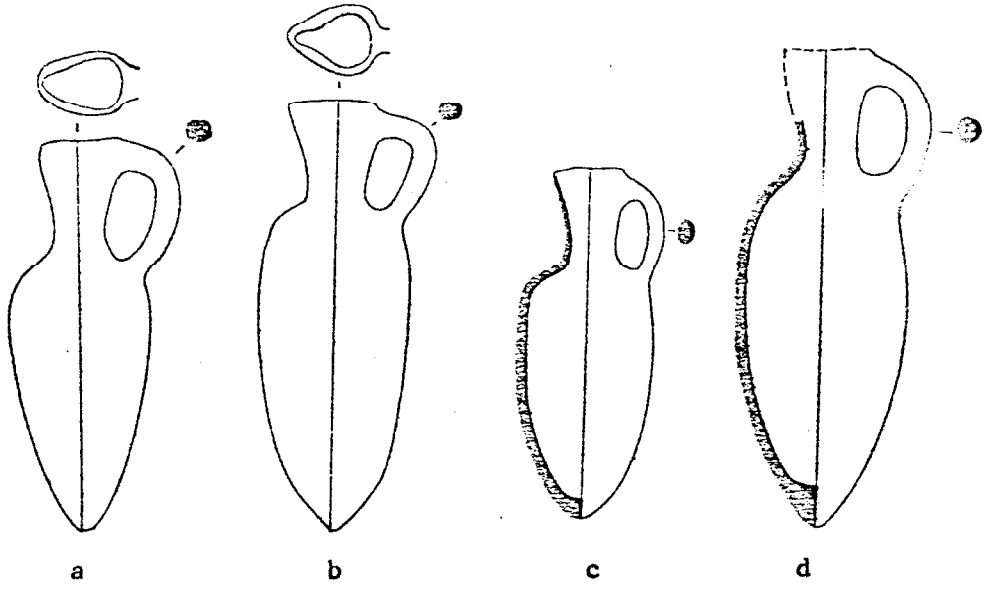

Fig. 414.--Jericho: Selected Pottery from Group ii Middle (Cont.)

Kenyon, Jericho II.

a. Fig. 149, No. 4

b. Fig. 136, No. 3

c. Fig. 131, No. 12

d. Fig. 135, No. 7

e. Fig. 148, No. 7

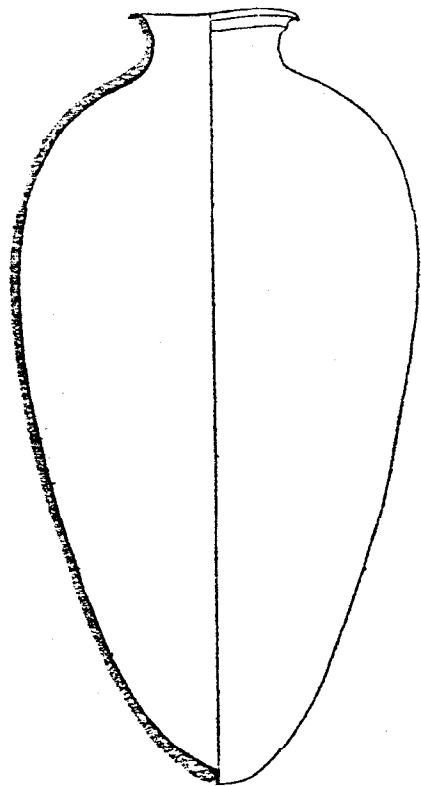

a

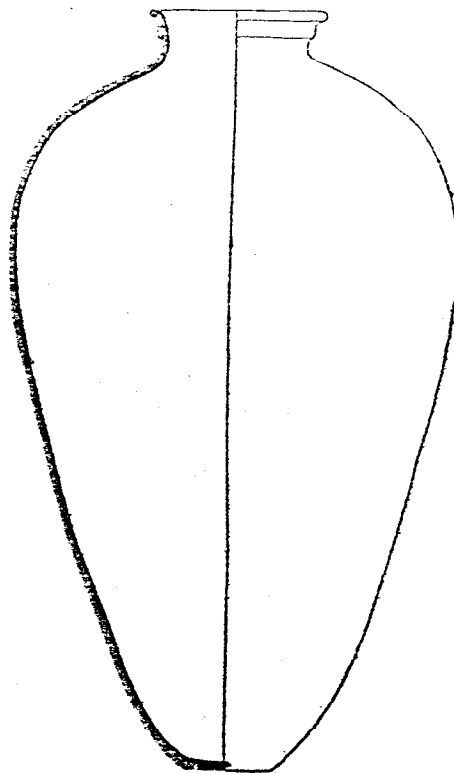

b

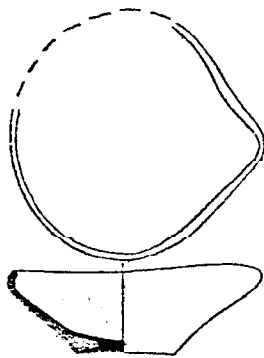

c

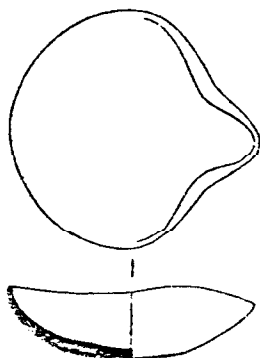

d

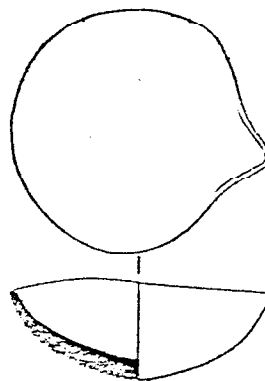

e

Fig. 415.--Jericho: Selected Pottery of Group ii Late, Tomb J14,
Phase I

Kenyon, Jericho II.

- a. Fig. 152, No. 6
- b. Fig. 152, No. 2
- c. Fig. 152, No. 7
- d. Fig. 152, No. 3
- e. Fig. 152, No. 10
- f. Fig. 152, No. 6
- g. Fig. 152, No. 11
- h. Fig. 153, No. 1
- i. Fig. 152, No. 13
- j. Fig. 153, No. 2
- k. Fig. 153, No. 4
- l. Fig. 153, No. 7
- m. Fig. 153, No. 9
- n. Fig. 153, No. 8
- o. Fig. 153, No. 3
- p. Fig. 153, No. 11

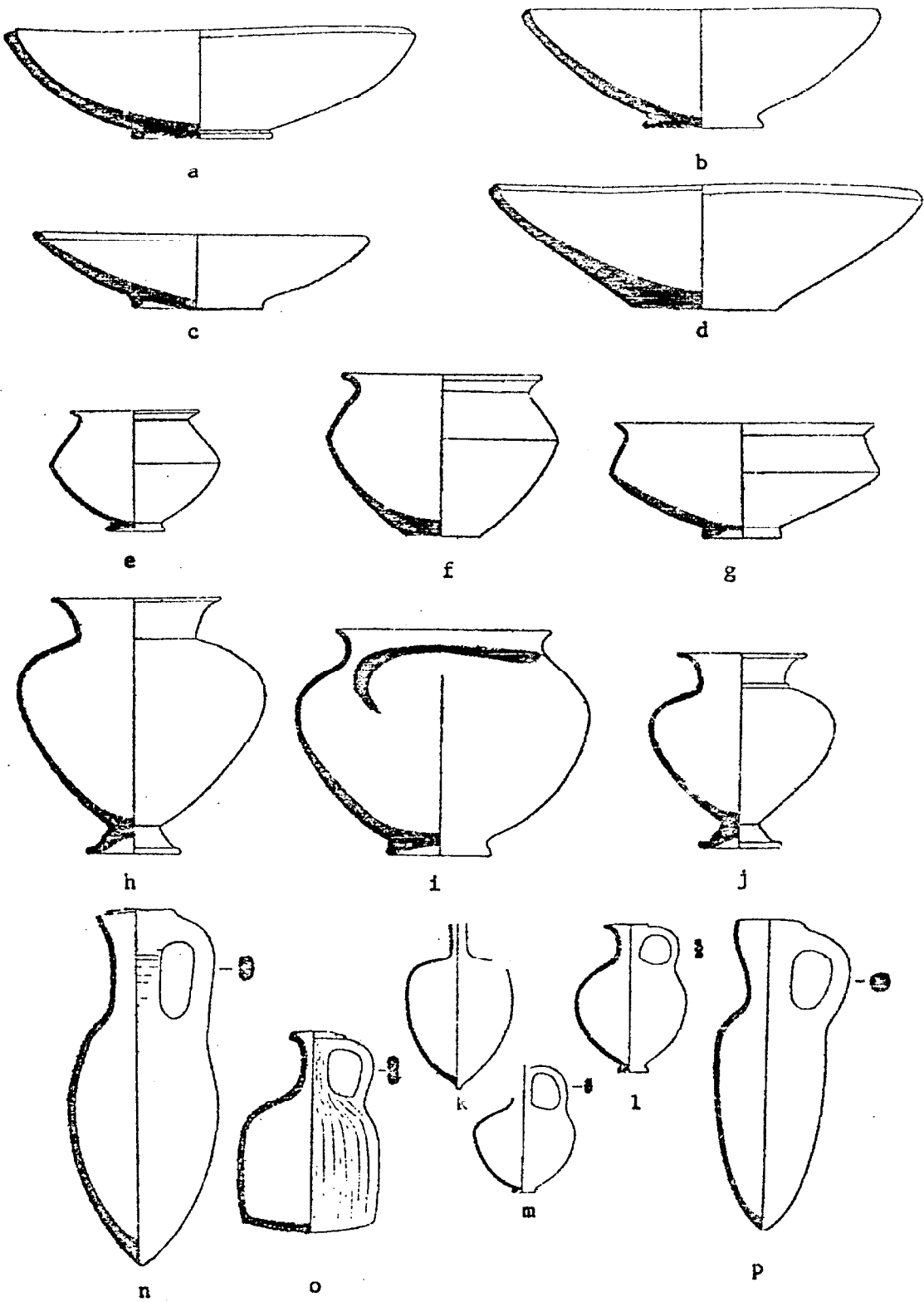

Fig. 416.--Jericho: Selected Pottery and Stone Vessels of Group ii
Late, Tomb J14, Phase I

Kenyon, Jericho II.

- a. Fig. 154, No. 12
- b. Fig. 154, No. 5
- c. Fig. 154, No. 8
- d. Fig. 154, No. 4
- e. Fig. 154, No. 14
- f. Fig. 154, No. 1
- g. Fig. 154, No. 3
- h. Fig. 154, No. 2
- i. Fig. 154, No. 10
- j. Fig. 154, No. 17
- k. Fig. 157, No. 13



a



b

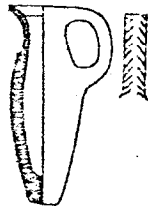

c



d

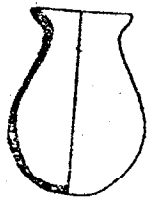

e

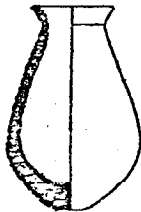

f

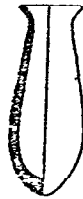

g

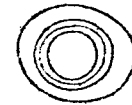

h



i

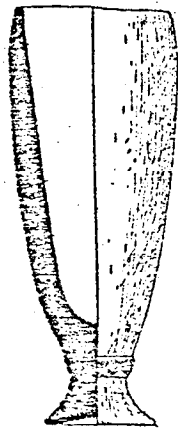

j

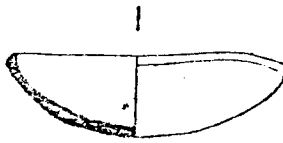
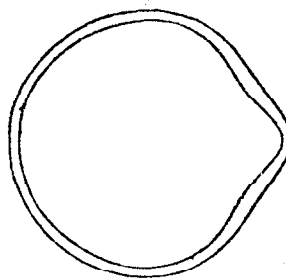

k

Fig. 417.--Jericho: Selected Pottery from Group ii Late, Tomb G33

Kenyon, Jericho I.

- a. Fig. 122, No. 4
- b. Fig. 122, No. 5
- c. Fig. 122, No. 8
- d. Fig. 122, No. 7
- c. Fig. 122, No. 6
- f. Fig. 122, No. 1
- g. Fig. 122, No. 15
- h. Fig. 122, No. 14
- i. Fig. 122, No. 16
- j. Fig. 122, No. 3
- k. Fig. 122, No. 10
- l. Fig. 122, No. 17

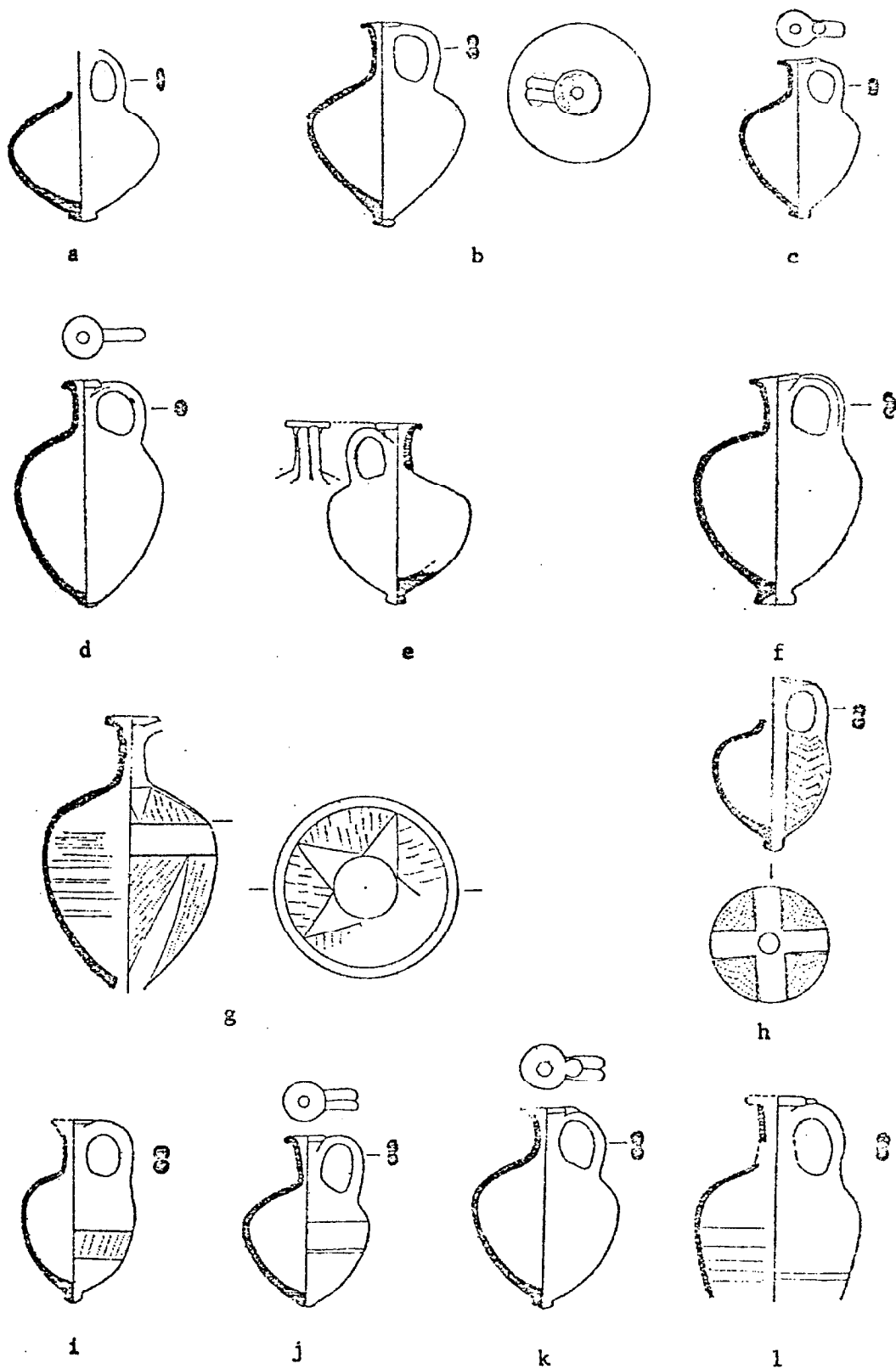

Fig. 418.--Jericho: Selected Stone Vessels from Group ii Late,
Tomb G33

Kenyon, Jericho I, Fig. 118.

a. No. 4

b. No. 7

c. No. 3

d. No. 5

e. No. 6

f. No. 7

g. No. 8

h. No. 10

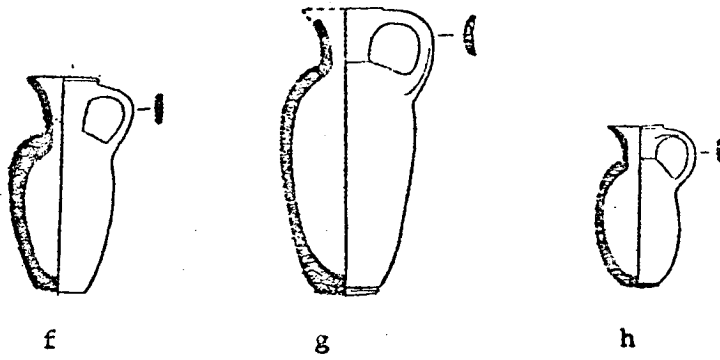
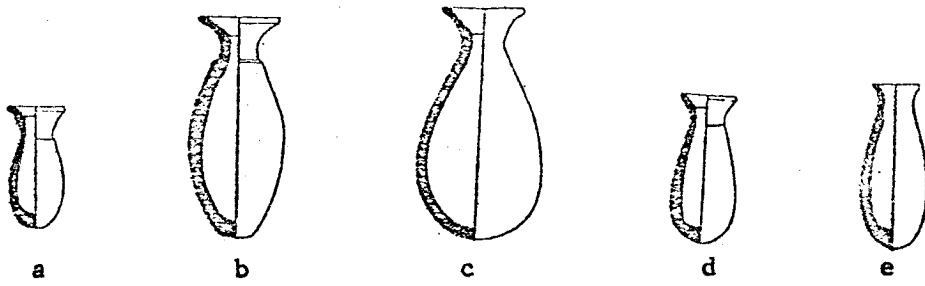

Fig. 419.--Jericho: Selected Juglets from Tomb A34, Group iii,
Early-Main

Kenyon, Jericho I, Fig. 142.

a. No. 10

b. No. 9

c. No. 8

d. No. 7

e. No. 1

f. No. 5

g. No. 6

h. No. 3

i. No. 18

j. No. 19

k. No. 16

l. No. 14

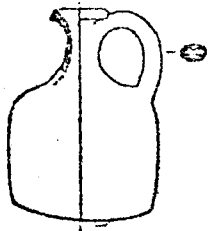

a

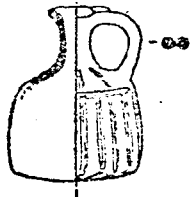

b

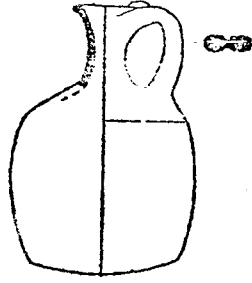

c

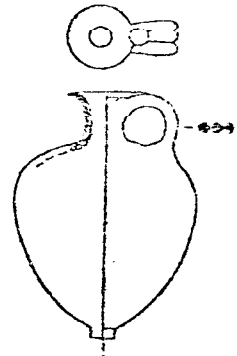

d

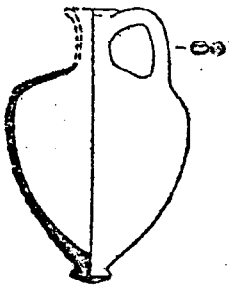

e

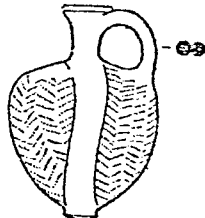

f

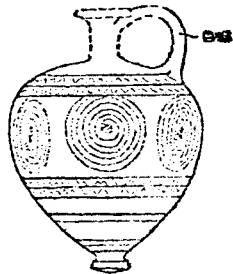

g

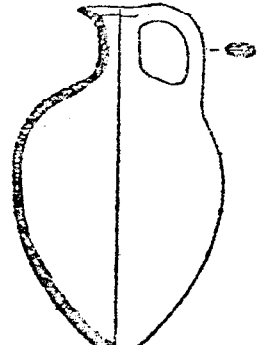

h

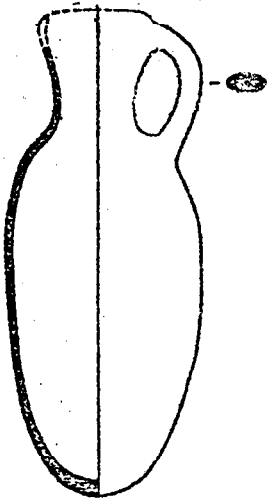

i

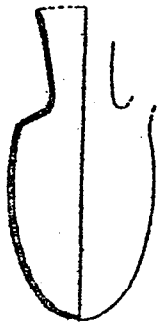

j

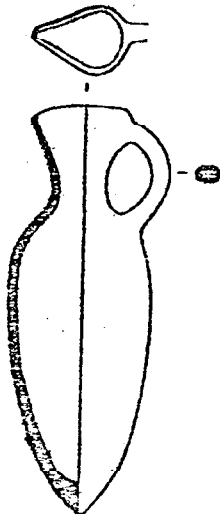

k

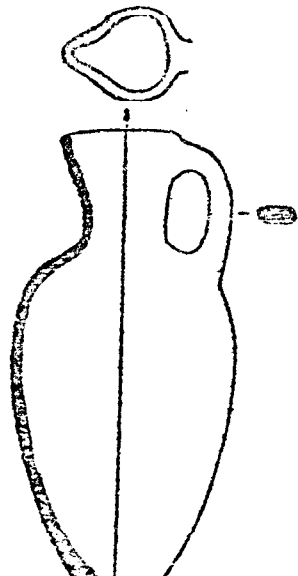

l

Fig. 420.--Jericho: Selected Pottery from Group iii, Early
Kenyon, Jericho II.

- a. Fig. 164, No. 1
- b. Fig. 164, No. 15
- c. Fig. 164, No. 8
- d. Fig. 165, No. 9
- e. Fig. 164, No. 18
- f. Fig. 164, No. 17
- g. Fig. 164, No. 25
- h. Fig. 165, No. 5
- i. Fig. 165, No. 4
- j. Fig. 165, No. 7
- k. Fig. 166, No. 5
- l. Fig. 165, No. 15
- m. Fig. 165, No. 14
- n. Fig. 166, No. 21

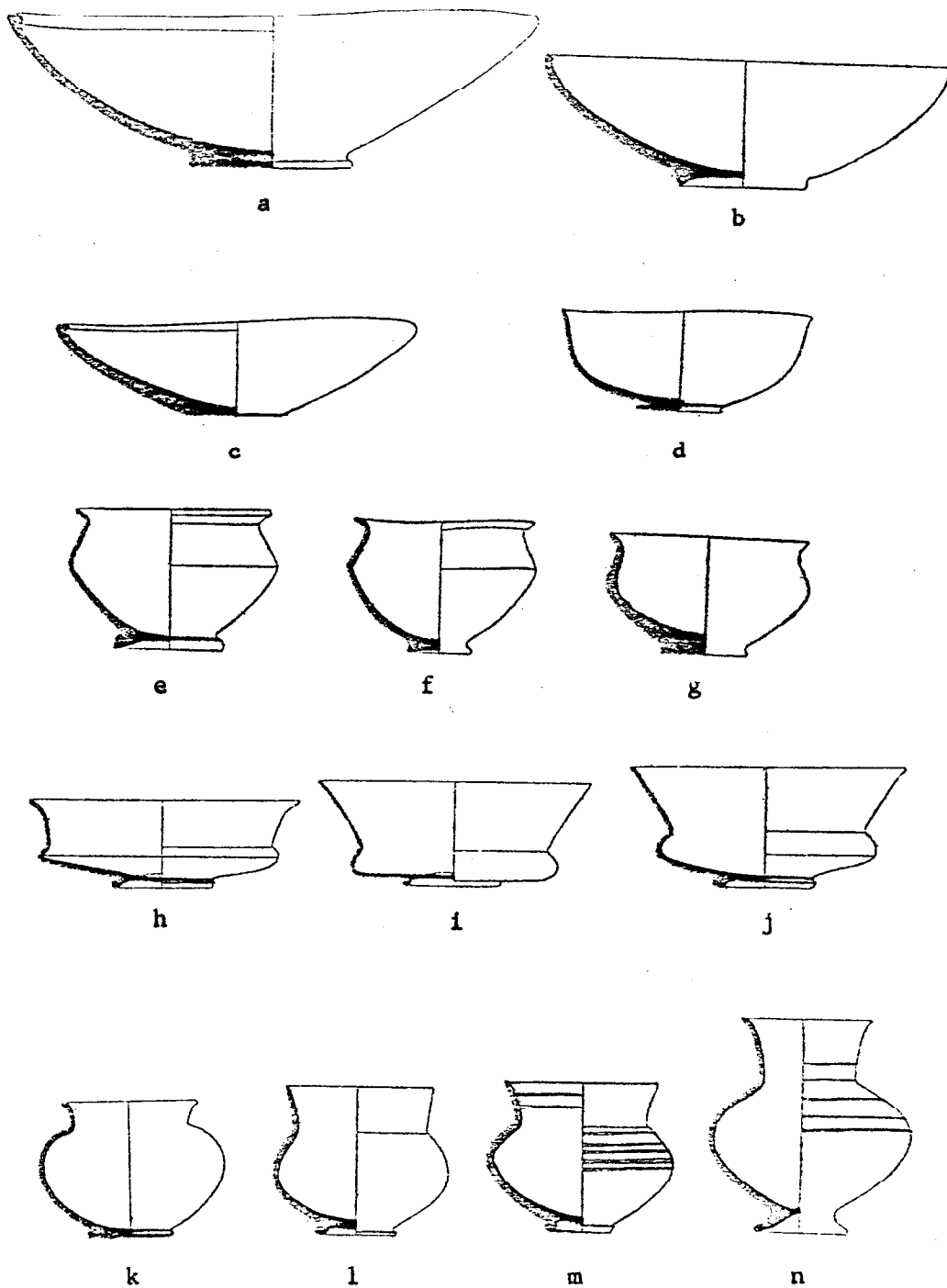

Fig. 421.--Jericho: Selected Pottery from Group iii, Early (Cont.)

Kenyon, Jericho II.

- a. Fig. 176, No. 4
- b. Fig. 166, No. 17
- c. Fig. 166, No. 12
- d. Fig. 166, No. 16
- e. Fig. 166, No. 18
- f. Fig. 176, No. 3
- g. Fig. 166, No. 11
- h. Fig. 166, No. 9
- i. Fig. 176, No. 7

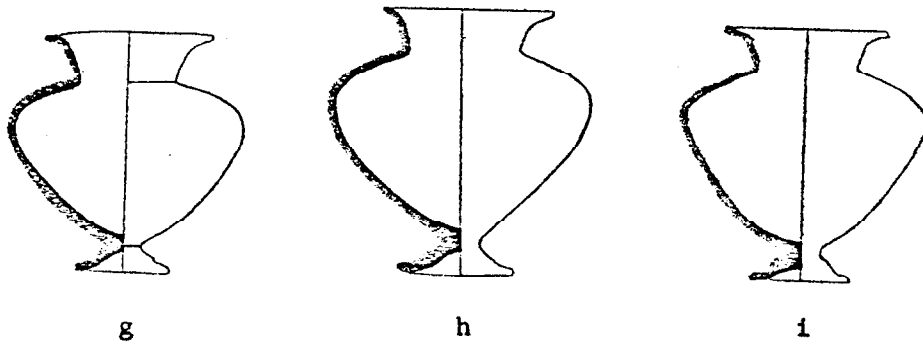
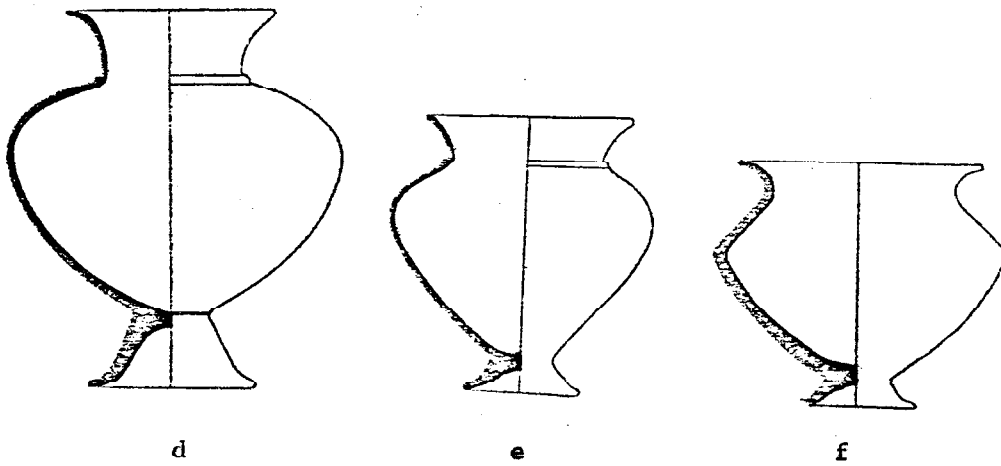
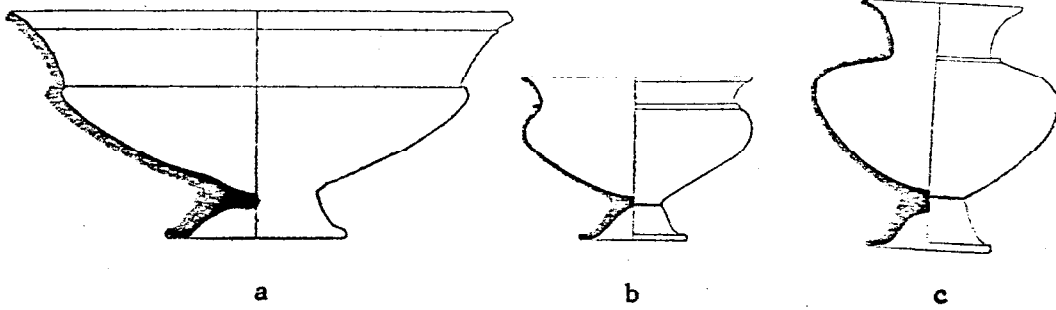
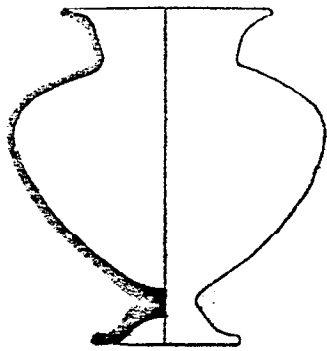

Fig. 422.--Jericho: Selected Pottery from Group iii, Early (Cont.)

Kenyon, Jericho II.

- a. Fig. 176, No. 8
- b. Fig. 165, No. 18
- c. Fig. 165, No. 19
- d. Fig. 165, No. 16
- e. Fig. 166, No. 1
- f. Fig. 166, No. 20
- g. Fig. 166, No. 19
- h. Fig. 165, No. 11



a

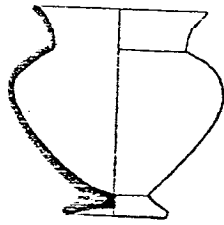

b

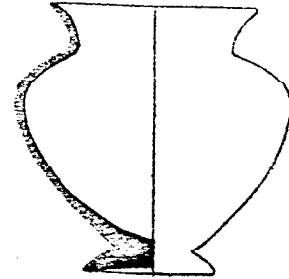

c

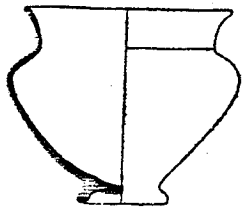

d

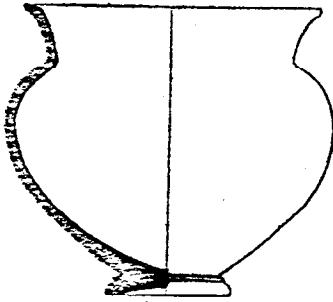

e

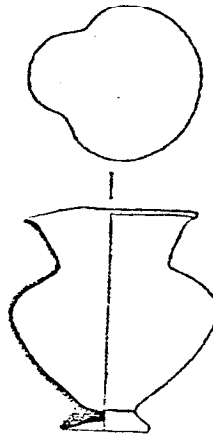

f

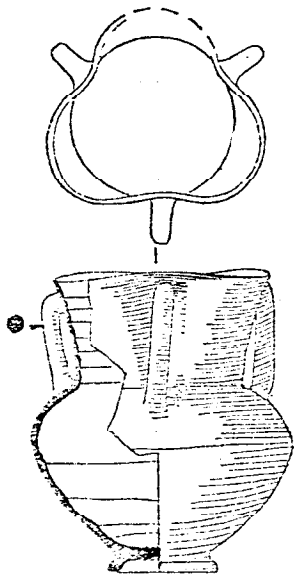

g

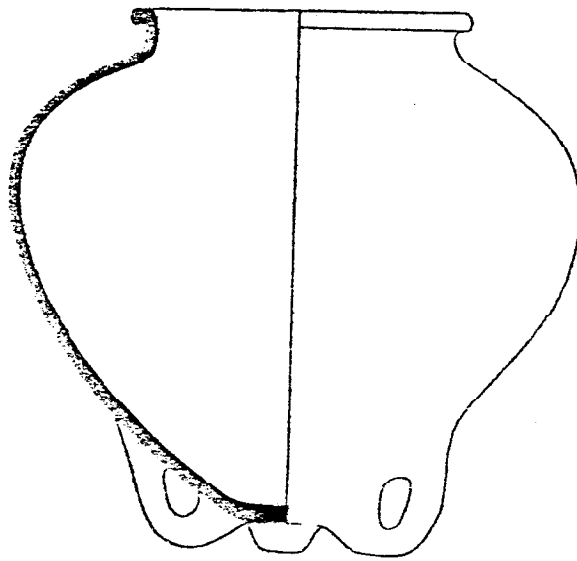

h

Fig. 423.--Jericho: Selected Pottery from Group iii, Early (Cont.)

Kenyon, Jericho II.

- a. Fig. 168, No. 16
- b. Fig. 177, No. 3
- c. Fig. 168, No. 19
- d. Fig. 168, No. 15
- e. Fig. 177, No. 4
- f. Fig. 168, No. 10
- g. Fig. 177, No. 1
- h. Fig. 168, No. 24
- i. Fig. 177, No. 6
- j. Fig. 177, No. 5
- k. Fig. 168, No. 25
- l. Fig. 168, No. 27

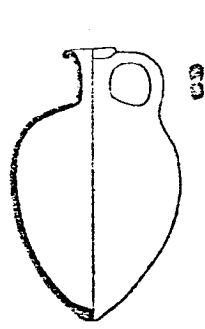

a

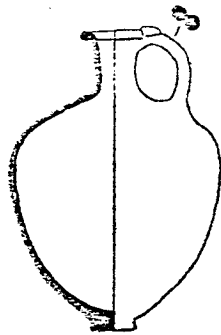

b

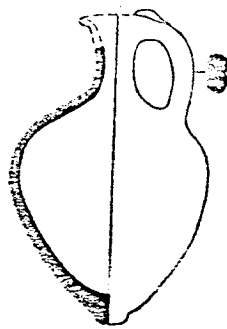

c

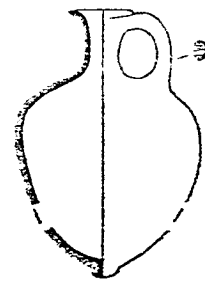

d

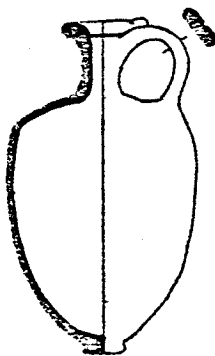

e

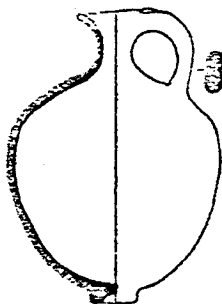

f

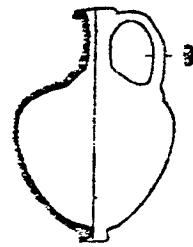

g

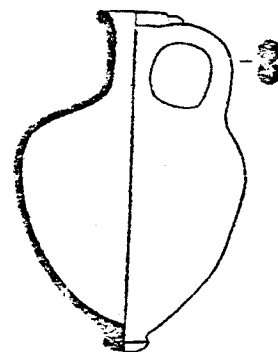

h

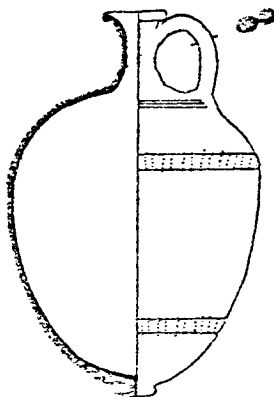

i

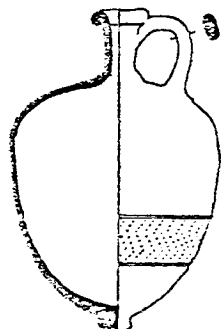

j

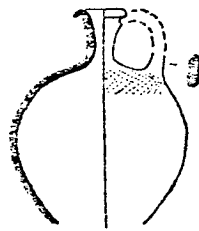

k

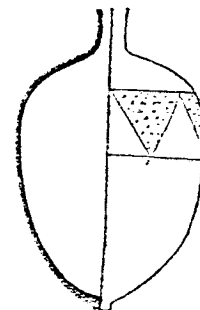

l

Fig. 424.--Jericho: Selected Pottery from Group iii, Early (Cont.)

Kenyon, Jericho II.

- a. Fig. 168, No. 26
- b. Fig. 168, No. 4
- c. Fig. 168, No. 3
- d. Fig. 168, No. 22
- e. Fig. 168, No. 29
- f. Fig. 169, No. 1
- g. Fig. 177, No. 7
- h. Fig. 169, No. 2
- i. Fig. 168, No. 32
- j. Fig. 168, No. 30
- k. Fig. 169, No. 7
- l. Fig. 177, No. 9
- m. Fig. 169, No. 10

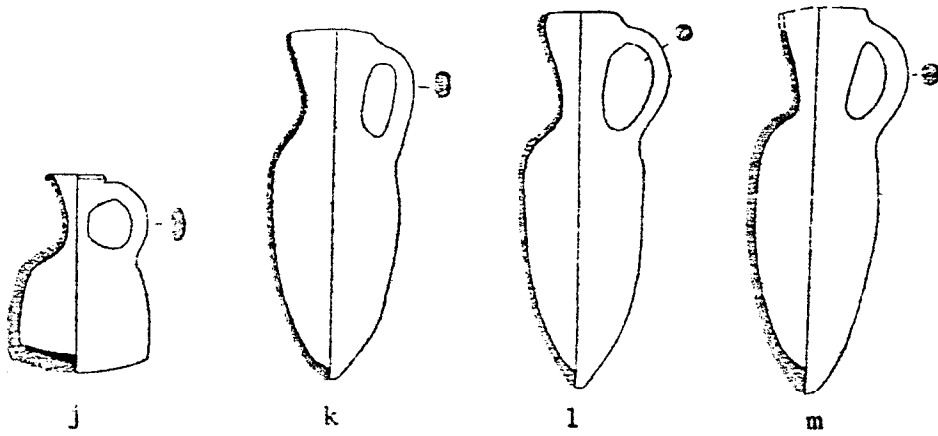
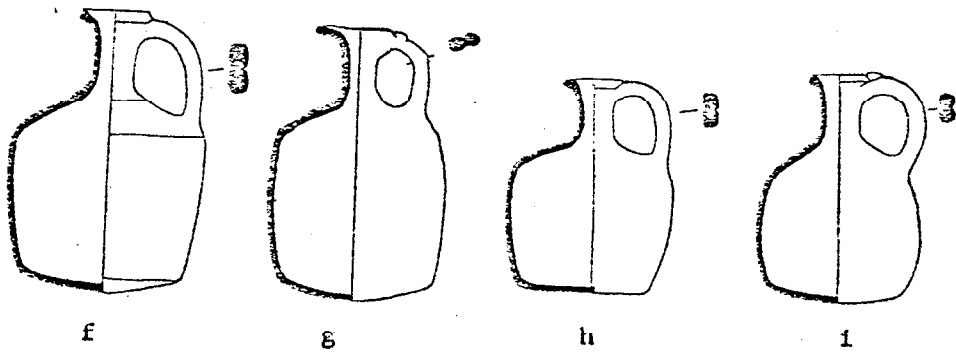
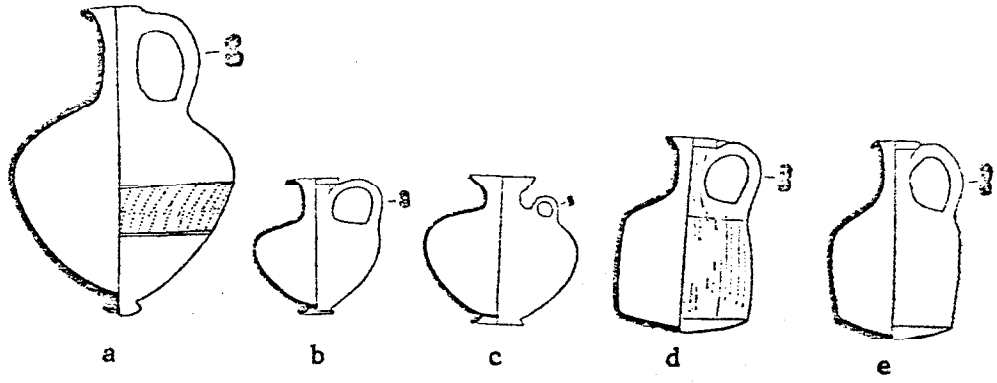

Fig. 425.--Jericho: Selected Pottery from Group iii, Early (Cont.)

Kenyon, Jericho II.

a. Fig. 169, No. 8

b. Fig. 169, No. 5

c. Fig. 167, No. 3

d. Fig. 176, No. 11

e. Fig. 176, No. 10

f. Fig. 176, No. 9

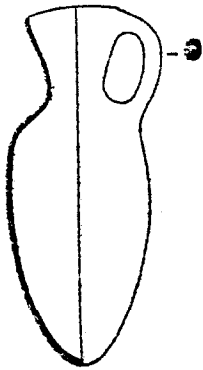

a

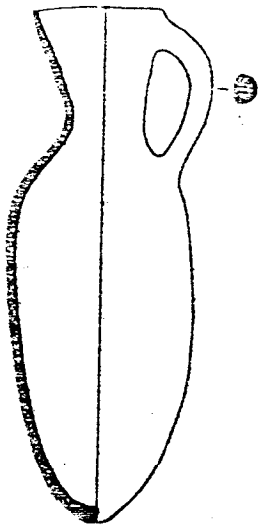

b

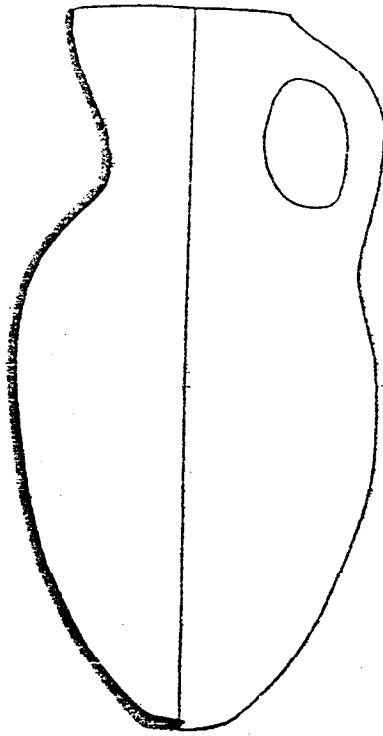

c

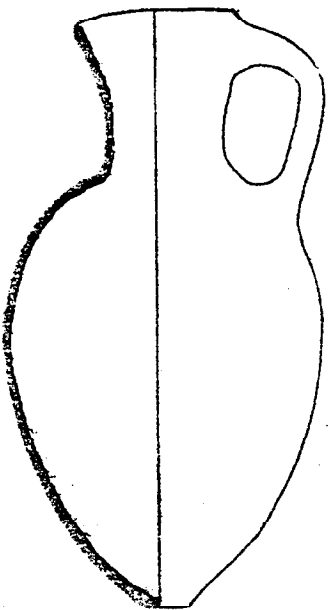

d

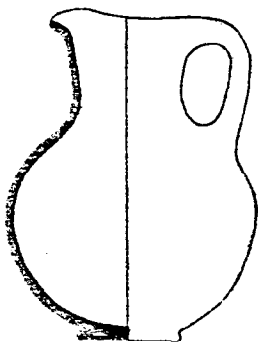

e

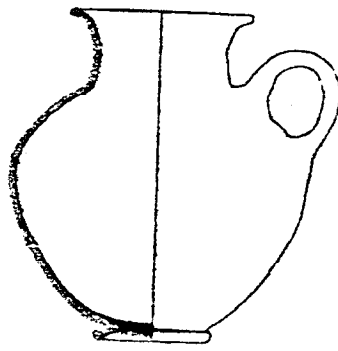

f

Fig. 426.--Jericho: Selected Pottery from Group iii, Early (Cont.)

Kenyon, Jericho II.

a. Fig. 165, No. 12

b. Fig. 167, No. 2

c. Fig. 167, No. 1

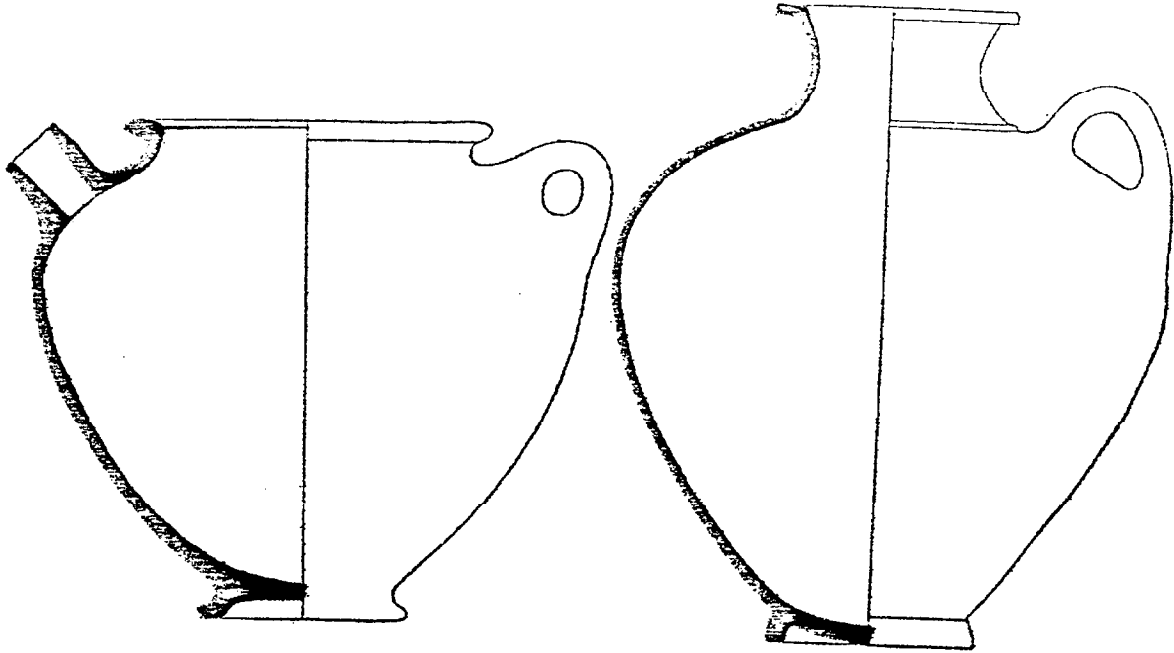

a

b

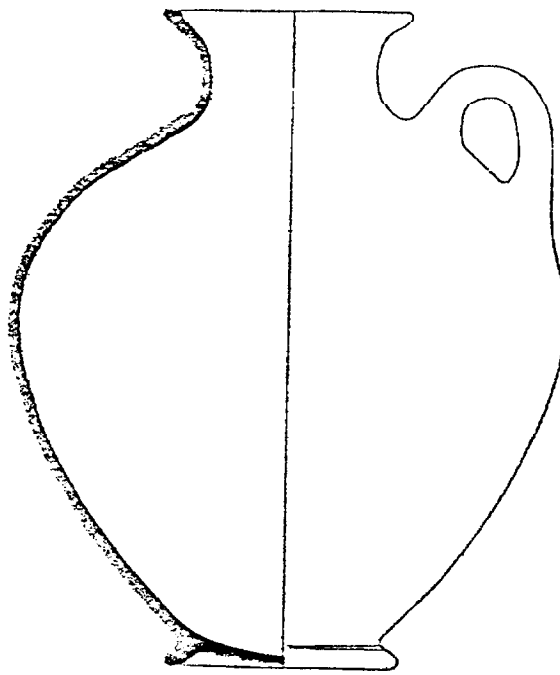

c

Fig. 427.--Jericho: Selected Pottery and Stone Vessels from
Group iii Early

Kenyon, Jericho II.

- a. Fig. 166, No. 8
- b. Fig. 177, No. 10
- c. Fig. 169, No. 20
- d. Fig. 171, No. 9
- e. Fig. 171, No. 2
- f. Fig. 171, No. 6
- g. Fig. 171, No. 5
- h. Fig. 171, No. 8
- i. Fig. 171, No. 13
- j. Fig. 171, No. 15
- k. Fig. 171, No. 11
- l. Fig. 179, No. 8
- m. Fig. 171, No. 1

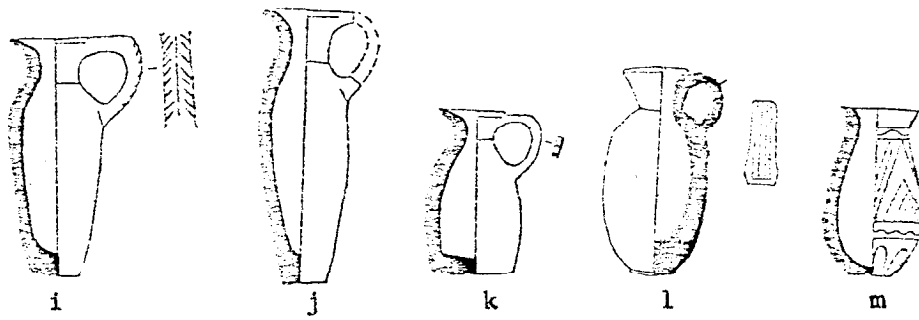
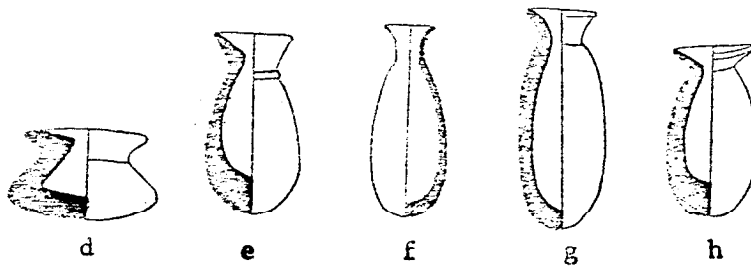
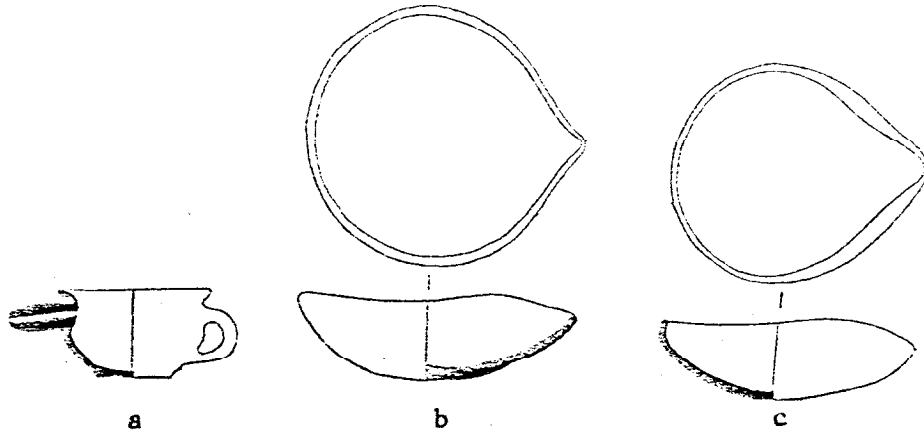

Fig. 428.--Jericho: Selected Pottery from Group iii Main

Kenyon, Jericho II.

a. Fig. 194, No. 8

b. Fig. 194, No. 7

c. Fig. 194, No. 4

1652

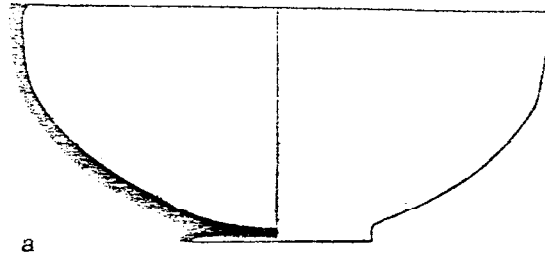

a

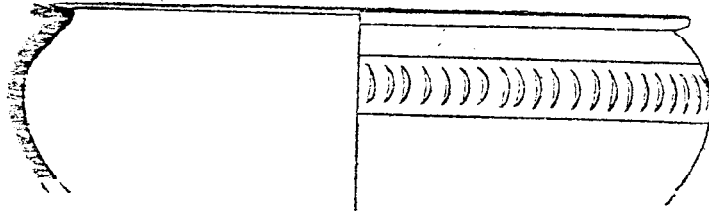

b

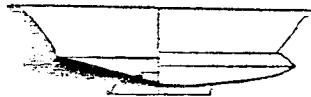

c

Fig. 429.--Jericho: Selected Pottery from Jericho Group iii Main
Kenyon, Jericho II

- a. Fig. 194, No. 2
- b. Fig. 196, No. 10
- c. Fig. 196, No. 11

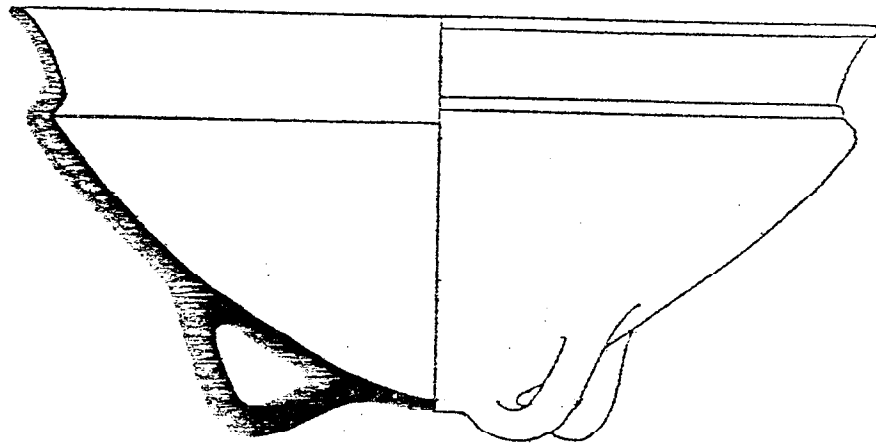

a

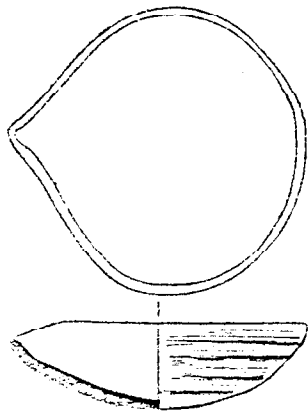

b

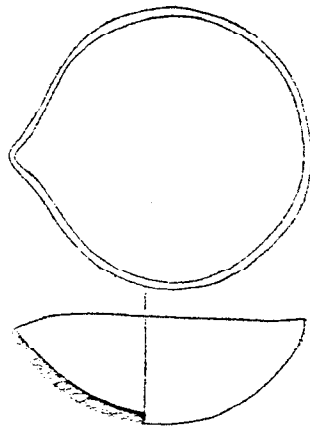

c

Fig. 430.--Jericho: Selected Pottery from Jericho Group iii Main
(Cont.)

Kenyon, Jericho II

- a. Fig. 213, No. 12
- b. Fig. 195, No. 9
- c. Fig. 213, No. 2
- d. Fig. 195, No. 2
- e. Fig. 195, No. 7

1656

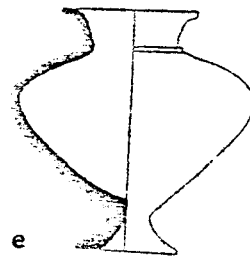
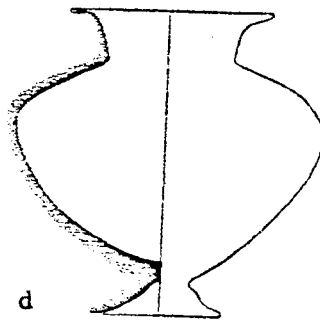
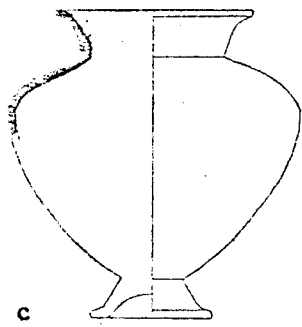
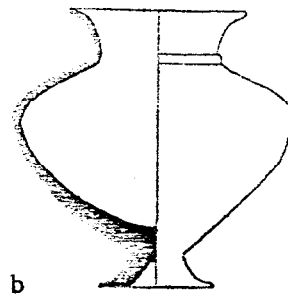
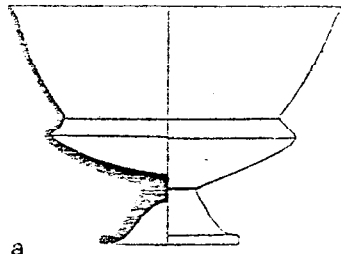

Fig. 431.--Jericho: Selected Pottery from Jericho Group iii Main
(Cont.)

Kenyon, Jericho II.

- a. Fig. 213, No. 9
- b. Fig. 213, No. 10
- c. Fig. 195, No. 11
- d. Fig. 213, No. 7
- e. Fig. 213, No. 6
- f. Fig. 213, No. 4

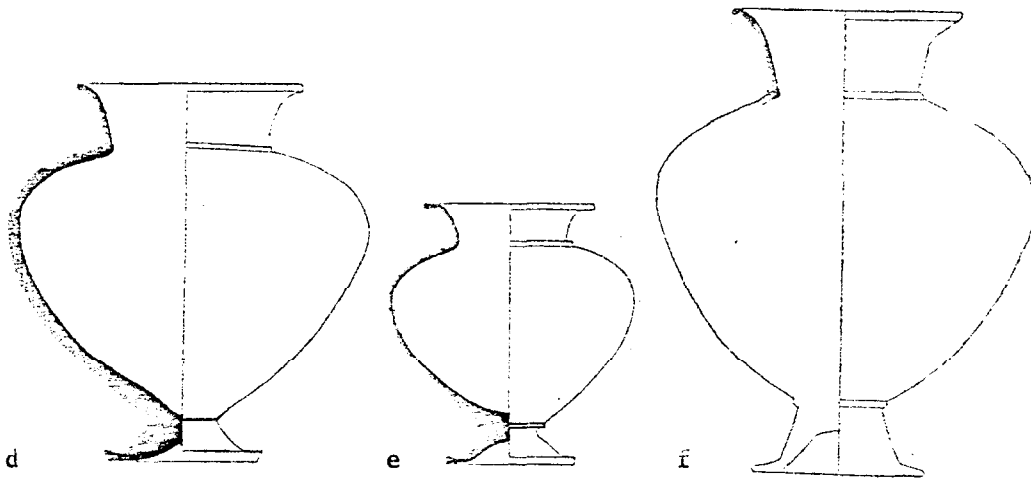
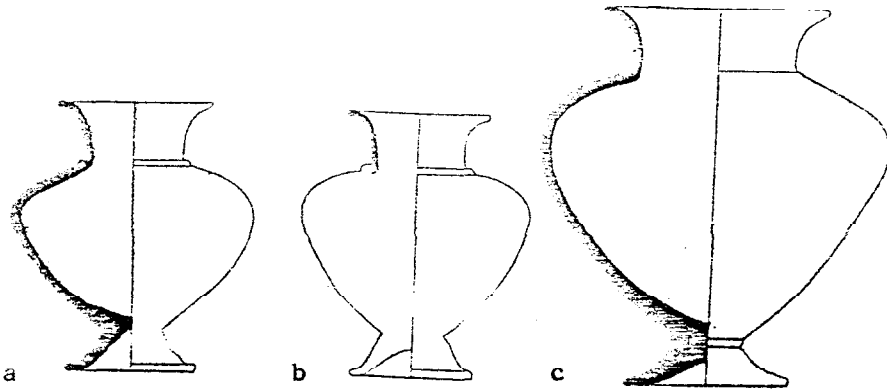

Fig. 432.--Jericho: Selected Pottery from Group iii Main (Cont.)

Kenyon, Jericho II.

a. Fig. 150, No. 2

b. Fig. 150, No. 3

c. Fig. 212, No. 1

d. Fig. 150, No. 1

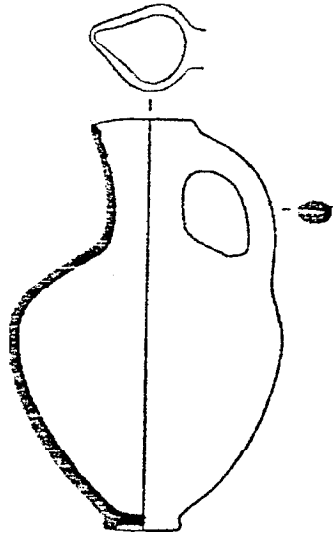

a

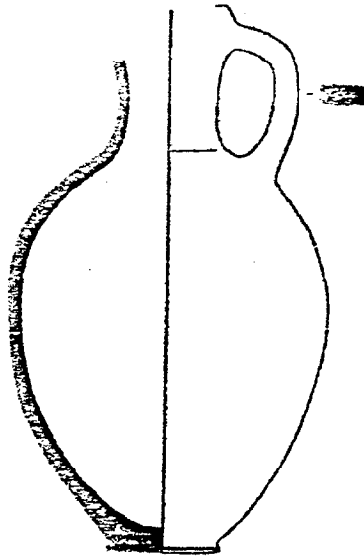

b

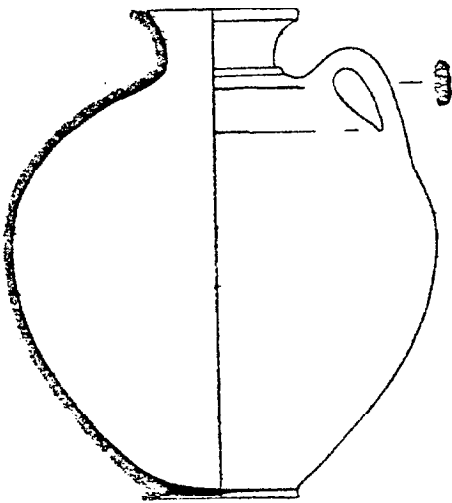

c

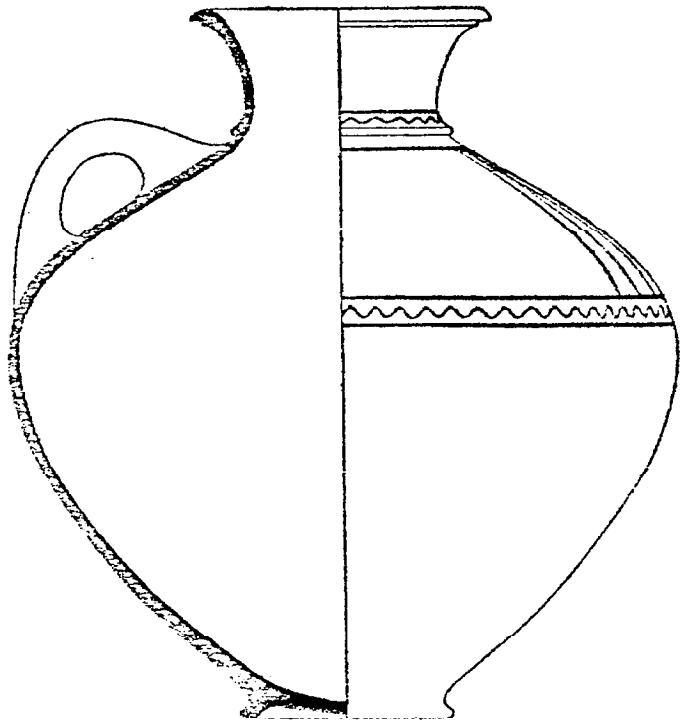

d

Fig. 433.--Jericho: Selected Pottery from Group iii Main (Cont.)

Kenyon, Jericho II.

- a. Fig. 150, No. 22
- b. Fig. 150, No. 21
- c. Fig. 150, No. 23
- d. Fig. 150, No. 7
- e. Fig. 150, No. 14
- f. Fig. 214, No. 1
- g. Fig. 196, No. 1
- h. Fig. 214, No. 5
- i. Fig. 150, No. 13
- j. Fig. 214, No. 3
- k. Fig. 150, No. 20
- l. Fig. 150, No. 12

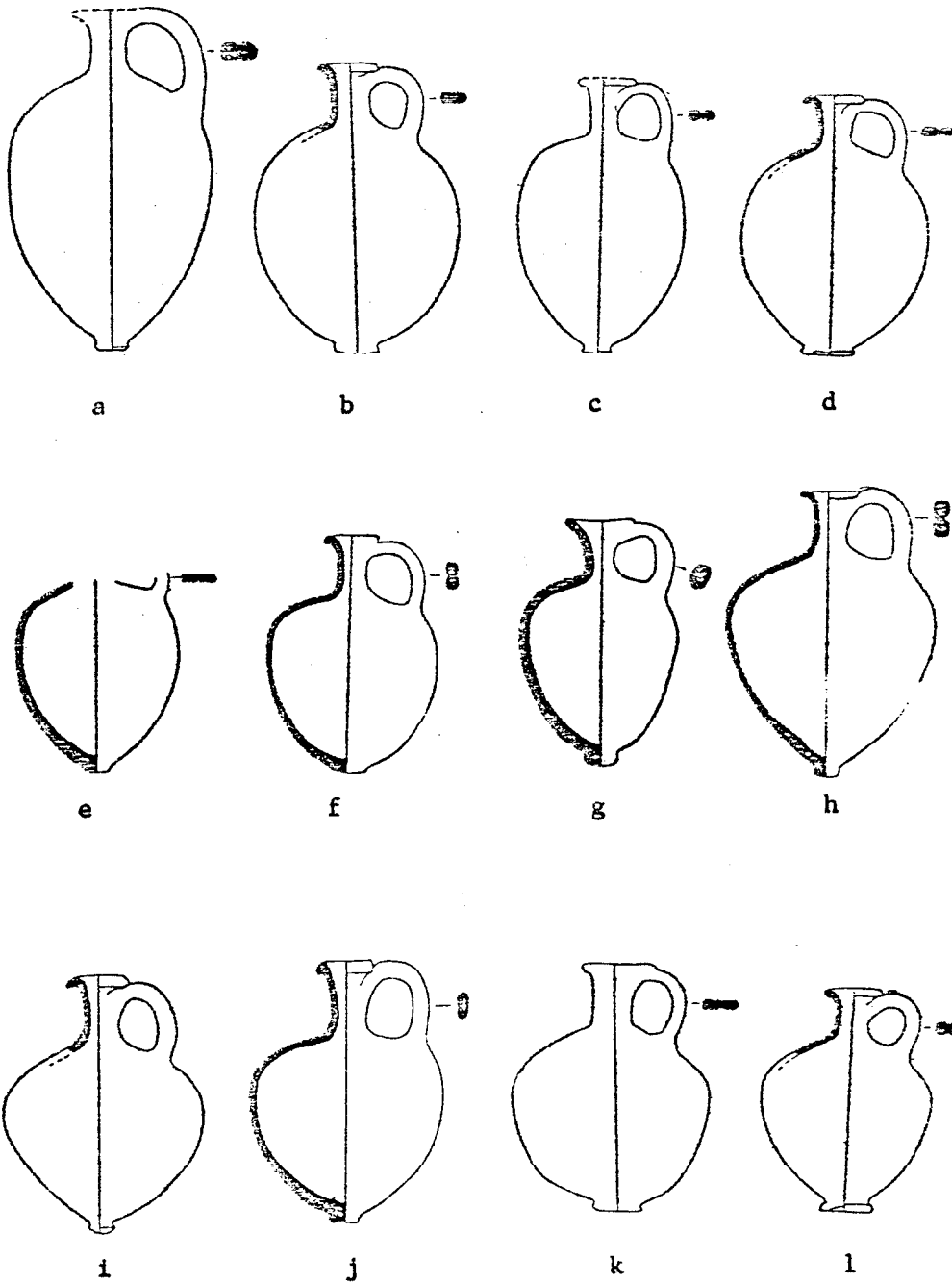

Fig. 434.--Jericho: Selected Pottery from Group iii Main (Cont.)

Kenyon, Jericho II.

- a. Fig. 150, No. 10
- b. Fig. 150, No. 17
- c. Fig. 150, No. 18
- d. Fig. 150, No. 8
- e. Fig. 150, No. 4
- f. Fig. 214, No. 6
- g. Fig. 214, No. 8
- h. Fig. 214, No. 9
- i. Fig. 214, No. 7
- j. Fig. 214, No. 14
- k. Fig. 215, No. 7
- l. Fig. 196, No. 8
- m. Fig. 196, No. 7
- n. Fig. 215, No. 2

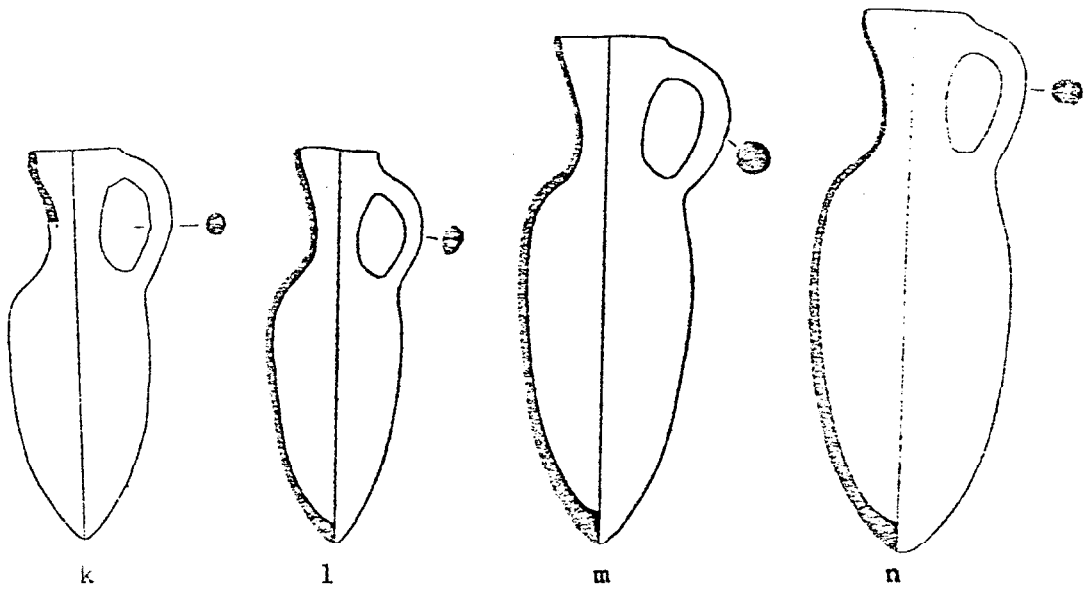
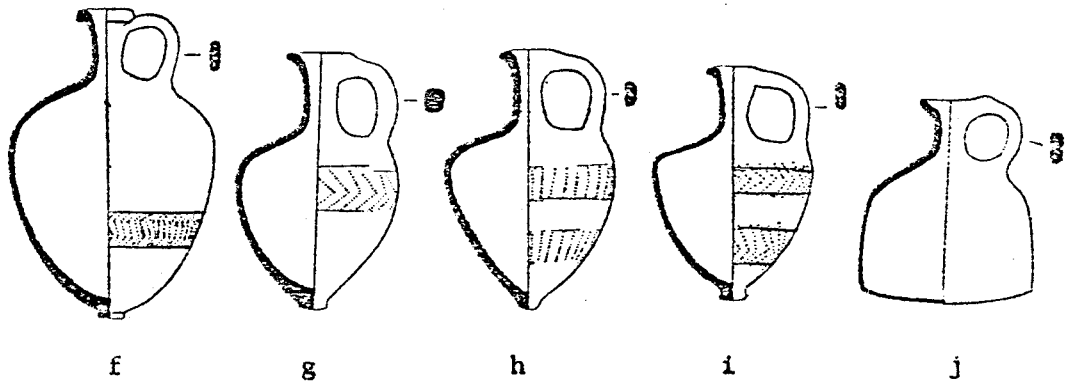
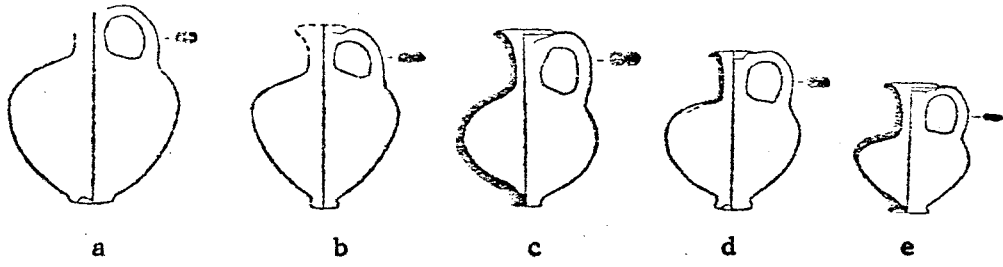

Fig. 435.--Jericho: Selected Pottery from Group iii Main (Cont.)

Kenyon, Jericho II.

a. Fig. 195, No. 1

b. Fig. 216, No. 5

c. Fig. 197, No. 2

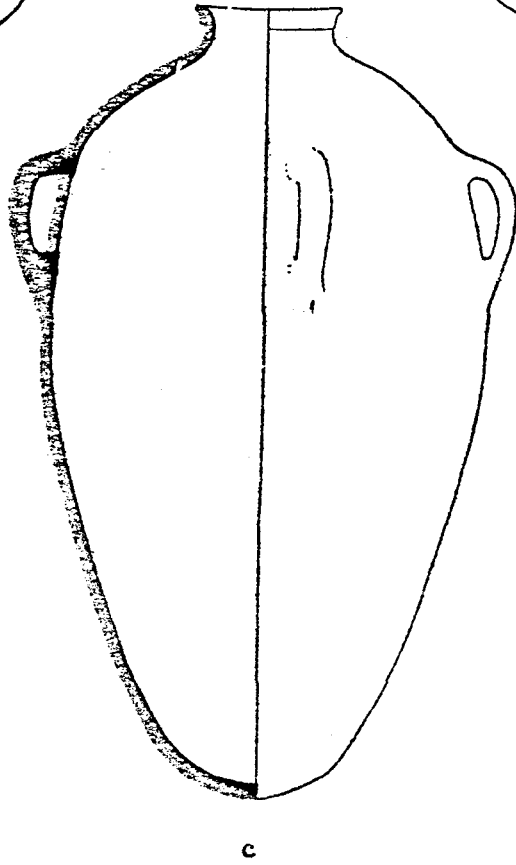
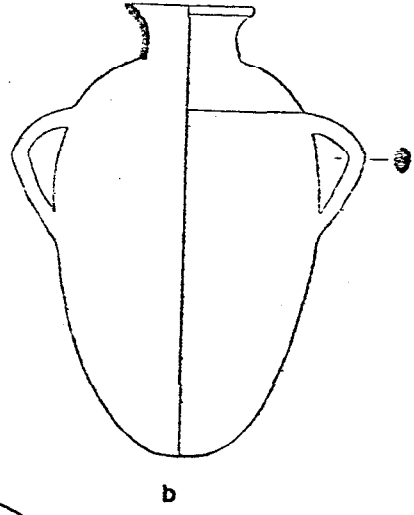
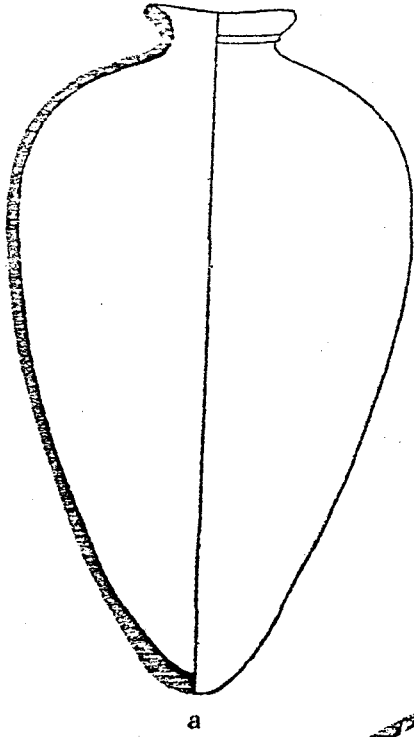

Fig. 436.--Jericho: Selected Stone Vessels from Group iii Main

Kenyon, Jericho II.

a. Fig. 118, No. 12

b. Fig. 118, No. 13

c. Fig. 118, No. 14

d. Fig. 118, No. 15



a

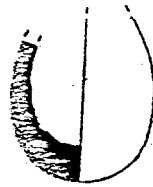

b



c



d

Fig. 437.--Jericho: Selected Pottery from Group iv

- a. Kenyon, Jericho II, Fig. 157, No. 2.
- b. Ibid., Fig. 179, No. 3
- c. Kenyon, Jericho I, Fig. 179, No. 4
- d. Kenyon, Jericho II, Fig. 234, No. 2
- e. Ibid., Fig. 212, No. 17
- f. Ibid., Fig. 234, No. 12
- g. Ibid., Fig. 234, No. 11
- h. Ibid., Fig. 185, No. 4
- i. Ibid., Fig. 185, No. 8

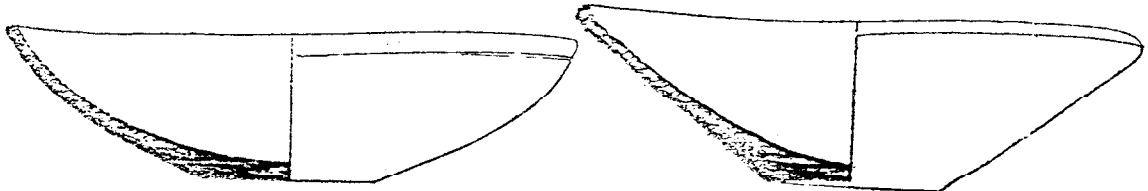

a

b

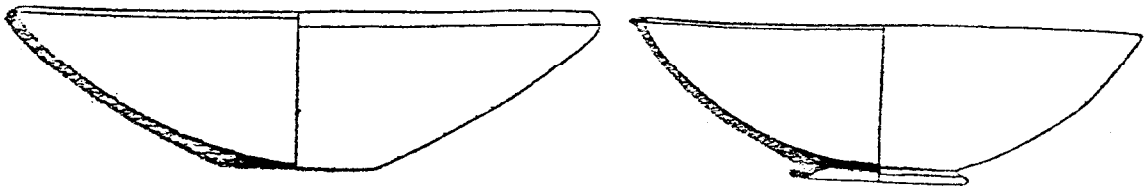

c

d

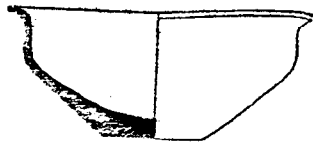

e

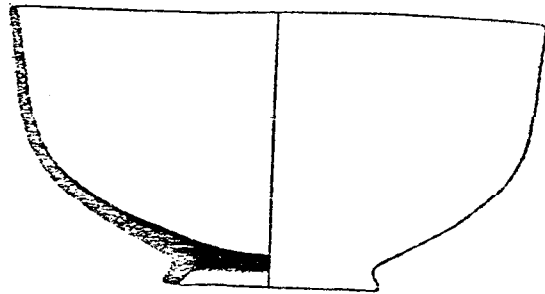

g

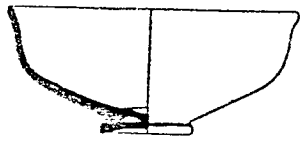

f

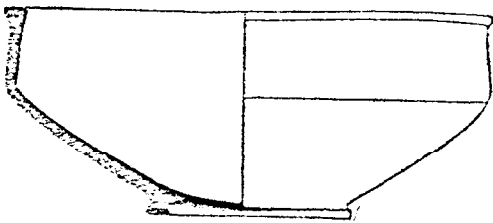

h

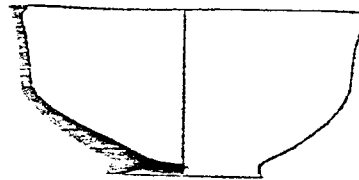

i

Fig. 438.--Jericho: Selected Pottery from Group iv (Cont.)

- a. Kenyon, Jericho II, Fig. 157, No. 3
- b. Ibid., Fig. 185, No. 2
- c. Ibid., Fig. 157, No. 4
- d. Ibid., Fig. 185, No. 1
- e. Kenyon, Jericho I, Fig. 179, No. 8
- f. Kenyon, Jericho II, Fig. 234, No. 7
- g. Ibid., Fig. 234, No. 8
- h. Kenyon, Jericho I, Fig. 179, No. 10
- i. Ibid., No. 9
- j. Kenyon, Jericho II, Fig. 185, No. 6
- k. Ibid., Fig. 212, No. 11

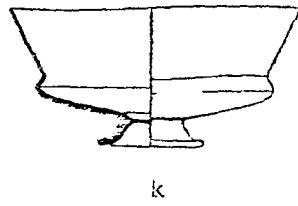
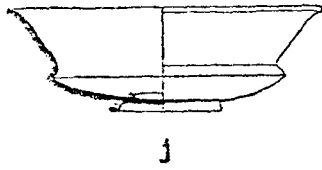
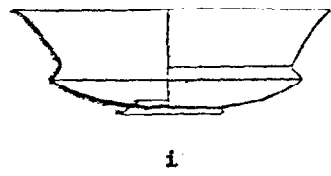
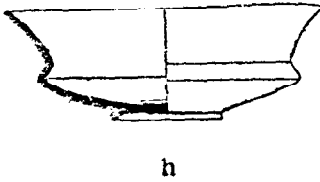
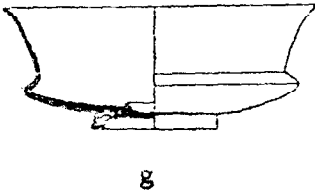
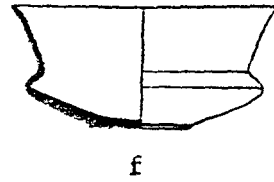
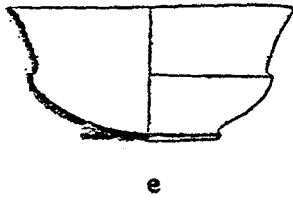
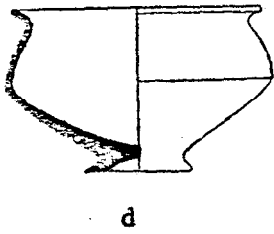
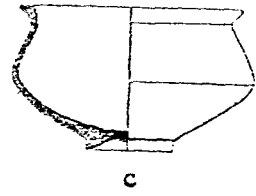
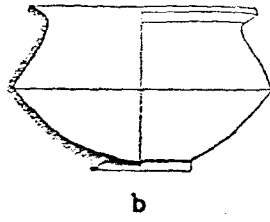
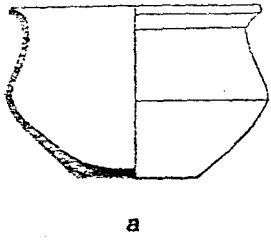
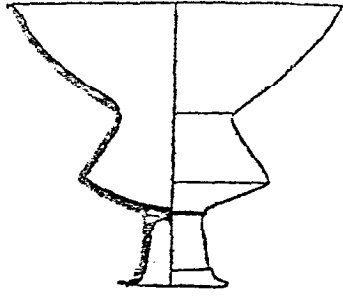
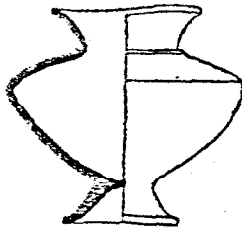

Fig. 439.--Jericho: Selected Pottery from Group iv (Cont.)

- a. Kenyon, Jericho I, Fig. 179, No. 20
- b. Ibid., No. 19
- c. Kenyon, Jericho II, Fig. 157, No. 13
- d. Ibid., Fig. 235, No. 3
- e. Ibid., Fig. 185, No. 11
- f. Kenyon, Jericho I, Fig. 179, No. 16
- g. Ibid., No. 17
- h. Kenyon, Jericho II, Fig. 235, No. 1
- i. Ibid., Fig. 185, No. 10



a



b

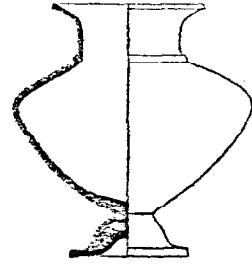

c

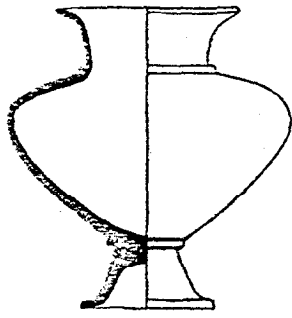

d

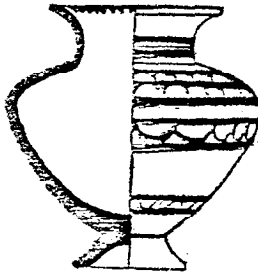

e

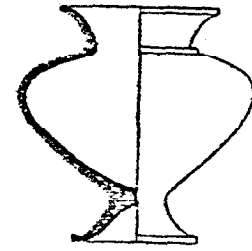

f

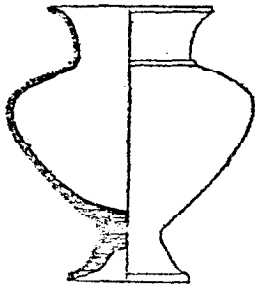

g

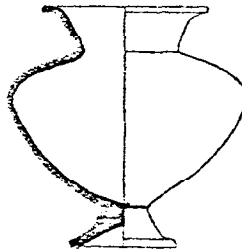

h

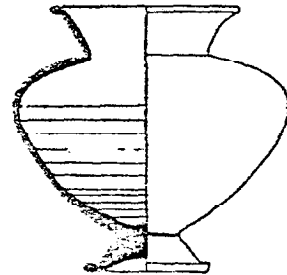

i

Fig. 440.--Jericho: Selected Pottery from Group iv (Cont.)

- a. Kenyon, Jericho II, Fig. 157, No. 9
- b. Ibid., No. 11
- c. Ibid., No. 10
- d. Ibid., Fig. 235, No. 2
- e. Kenyon, Jericho I, Fig. 179, No. 18.
- f. Ibid., No. 14
- g. Kenyon, Jericho II, Fig. 160, No. 8
- h. Ibid., Fig. 236, No. 7
- i. Kenyon, Jericho I, Fig. 181, No. 1

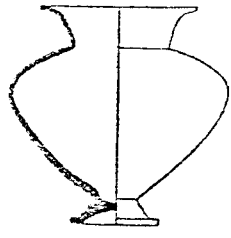

a

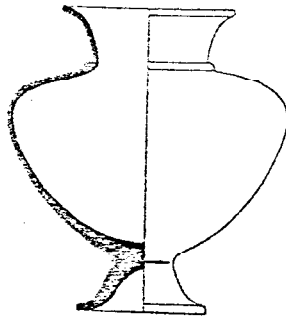

b

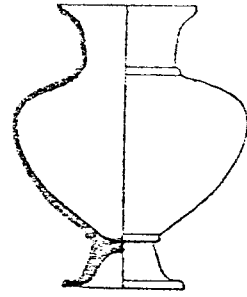

c

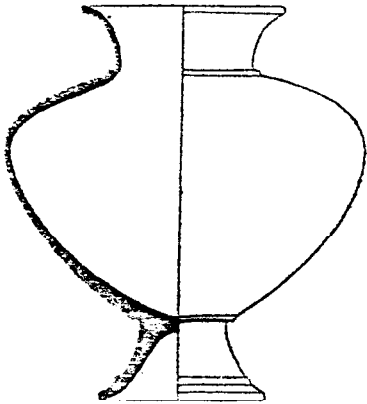

d

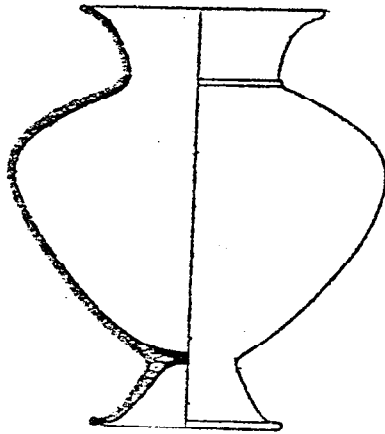

e

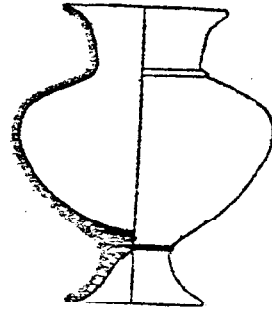

f

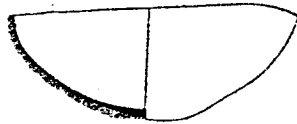
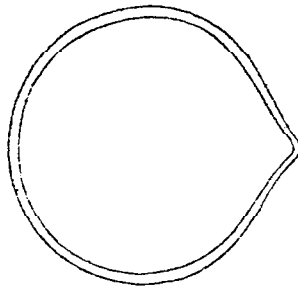

g

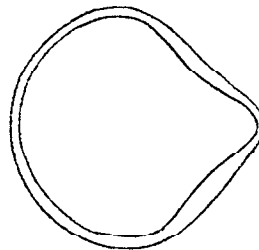

h

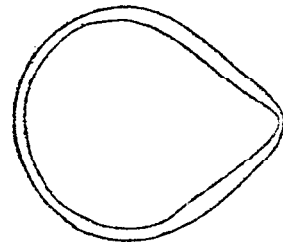

i

Fig. 441.--Jericho: Selected Pottery from Group iv (Cont.)

Kenyon, Jericho II.

- a. Fig. 235, No. 7
- b. Fig. 158, No. 2
- c. Fig. 158, No. 1
- d. Fig. 235, No. 8

1673

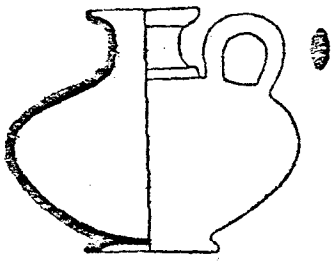

a

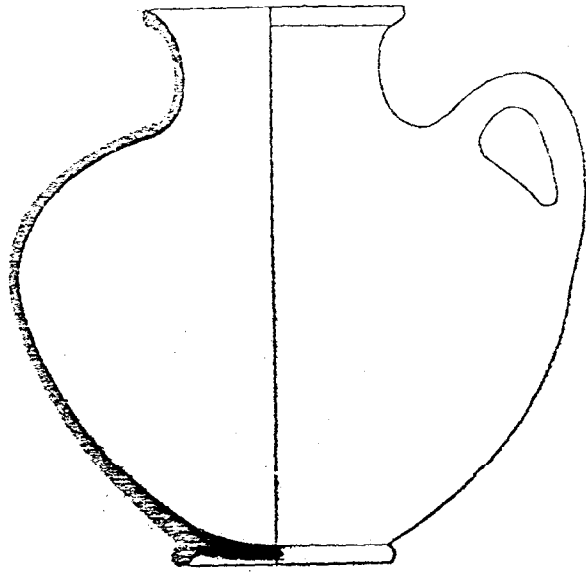

b

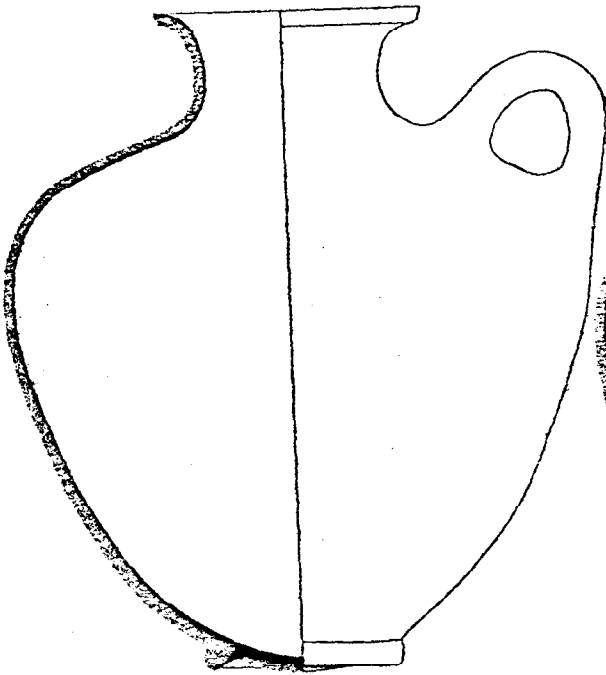

c

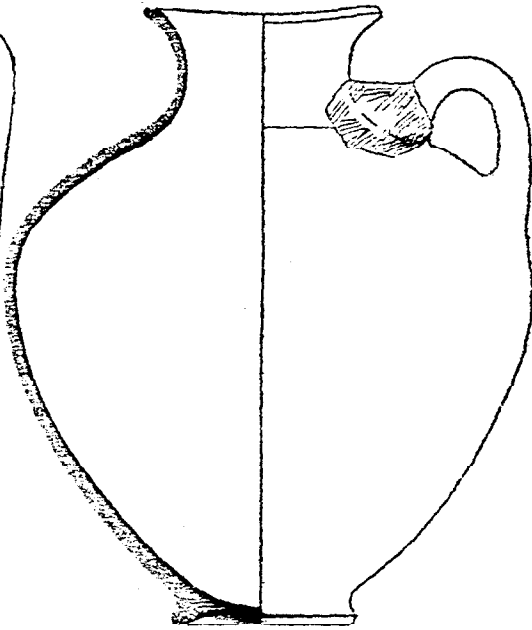

d

Fig. 442,--Jericho: Selected Pottery from Group iv (Cont.)

Kenyon, Jericho II.

- a. Fig. 185, No. 12
- b. Fig. 186, No. 1
- c. Fig. 185, No. 16
- d. Fig. 186, No. 2
- e. Fig. 186, No. 4
- f. Fig. 186, No. 3
- g. Fig. 235, No. 9
- h. Fig. 159, No. 9
- i. Fig. 159, No. 8
- j. Fig. 186, No. 6
- k. Fig. 235, No. 12
- l. Fig. 235, No. 4

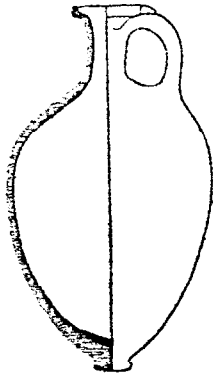

a

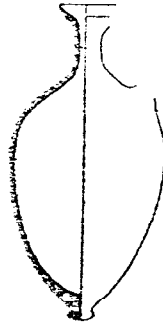

b

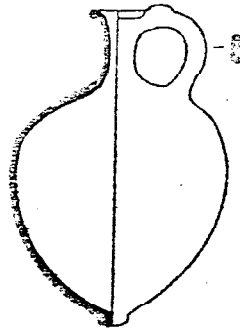

c

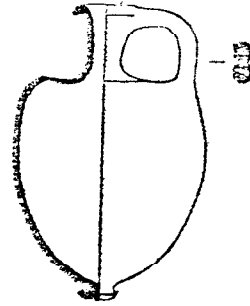

d

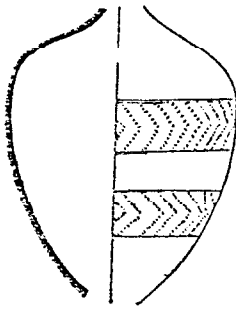

e

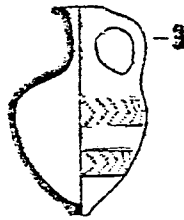

f

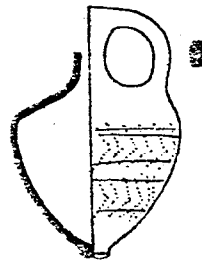

g

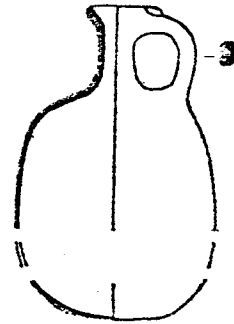

h

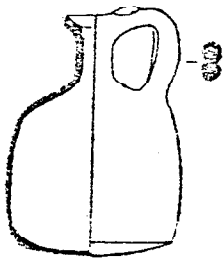

i

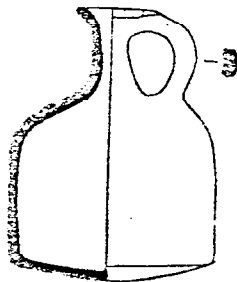

j

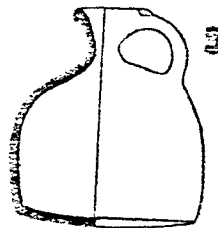

k

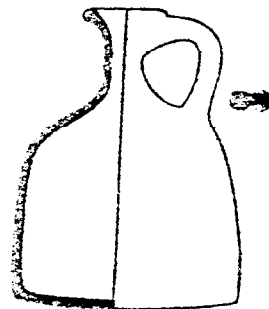

l

Fig. 443.--Jericho: Selected Pottery from Group iv (Cont.)

Kenyon, Jericho II.

- a. Fig. 235, No. 14
- b. Fig. 186, No. 7
- c. Fig. 186, No. 5
- d. Fig. 237, No. 1
- e. Fig. 160, No. 1
- f. Fig. 236, No. 1
- g. Fig. 186, No. 9
- h. Fig. 236, No. 5
- i. Fig. 160, No. 3

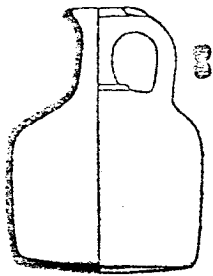

a

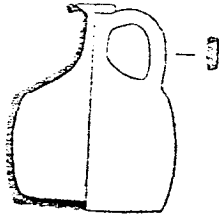

b

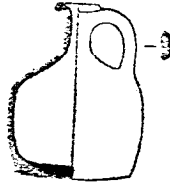

c

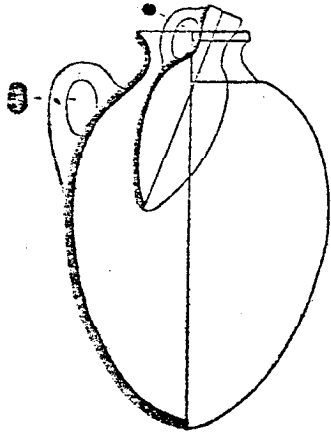

d

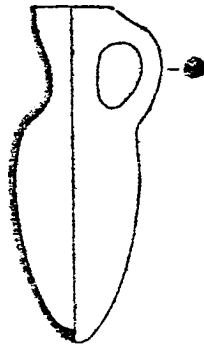

e

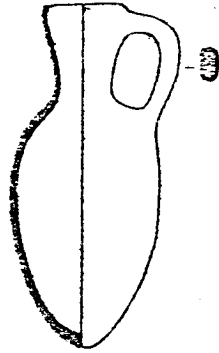

f

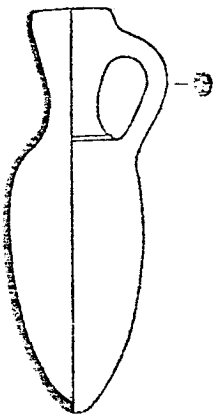

g

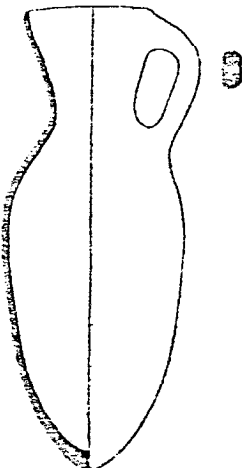

h

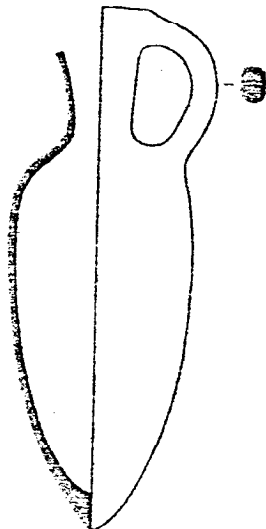

i

Fig. 444.--Jericho: Selected Pottery from Group iv (Cont.)

Kenyon, Jericho II.

a. Fig. 159, No. 4

b. Fig. 159, No. 2

c. Fig. 161, No. 5

d. Fig. 161, No. 1

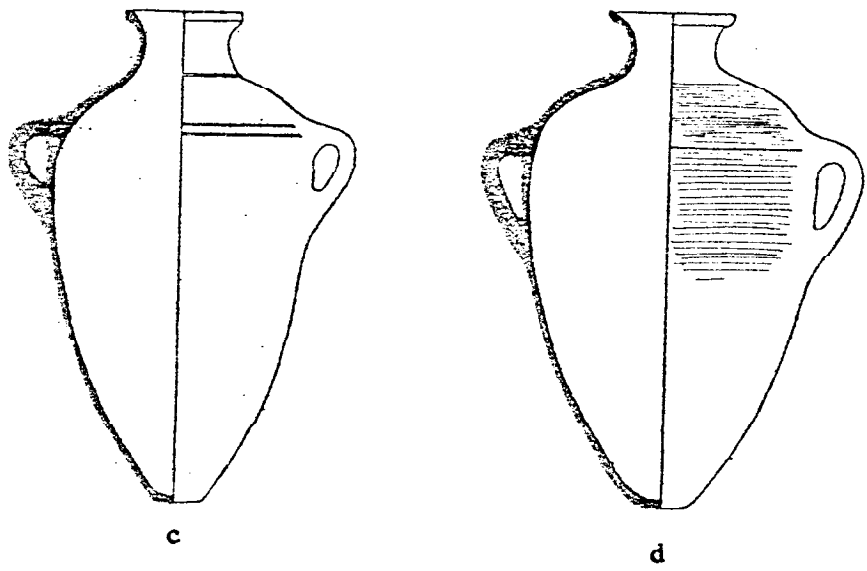
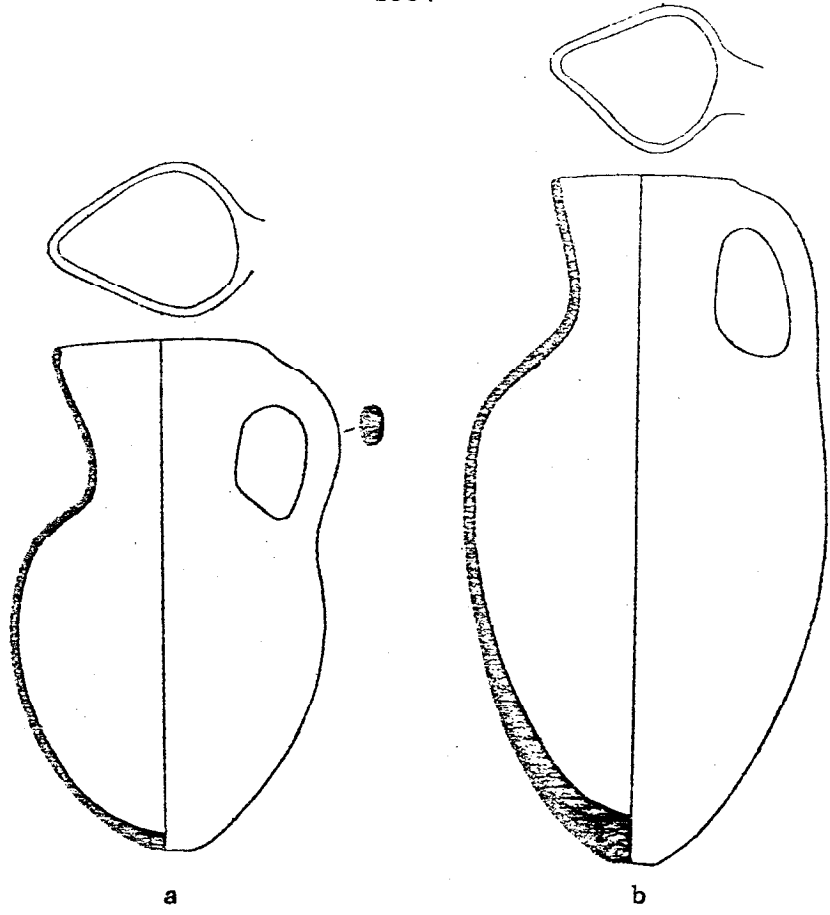

Fig. 445.--Jericho: Stone and Faience Vessels from Group iv

a. Kenyon, Jericho II, Fig. 238, No. 2

b. Ibid., No. 1

c. Kenyon, Jericho I, Fig. 181, No. 8

d. Ibid., No. 5

e. Ibid., No. 6

f. Ibid., No. 7



a



b

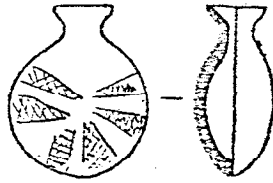

c



d



e



f

Fig. 446,--Jericho: Selected Pottery from Group v

Kenyon, Jericho II.

a. Fig. 247, No. 1

b. Fig. 247, No. 8

c. Fig. 251, No. 3

d. Fig. 247, No. 9

c. Fig. 251, No. 1

f. Fig. 247, No. 2

g. Fig. 251, No. 2

h. Fig. 247, No. 7

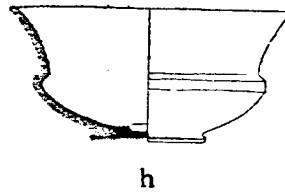
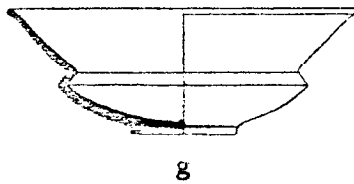
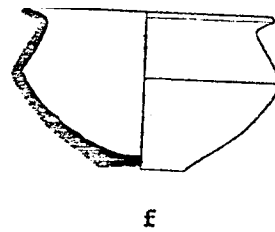
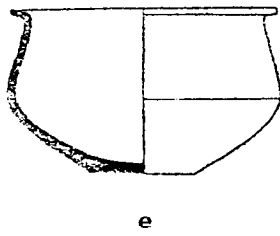
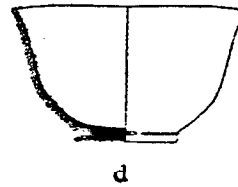
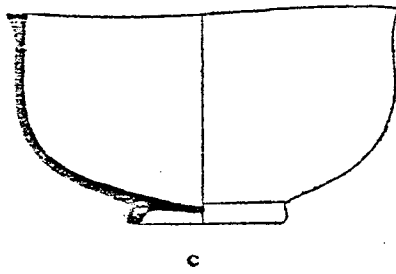
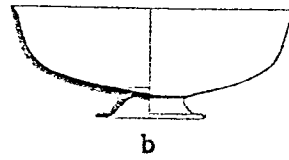
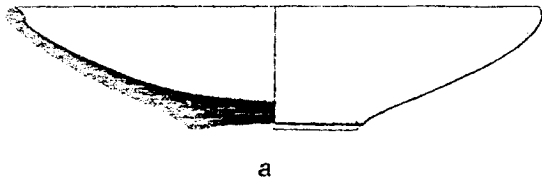

Fig. 447.--Jericho: Selected Pottery from Group v (Cont.)

Kenyon, Jericho II.

- a. Fig. 265, No. 18
- b. Fig. 248, No. 18
- c. Fig. 251, No. 26
- d. Fig. 247, No. 11
- e. Fig. 247, No. 12
- f. Fig. 251, No. 5
- g. Fig. 251, No. 19
- h. Fig. 248, No. 14
- i. Fig. 251, No. 20

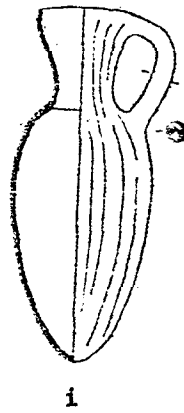
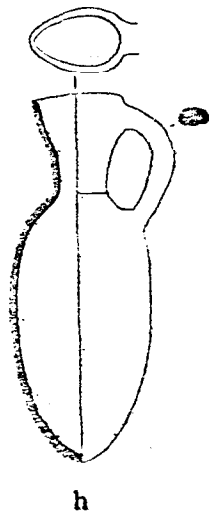
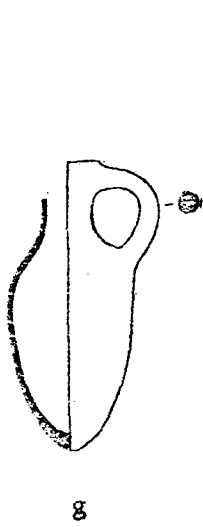
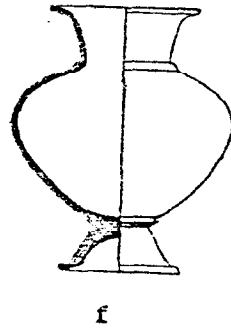
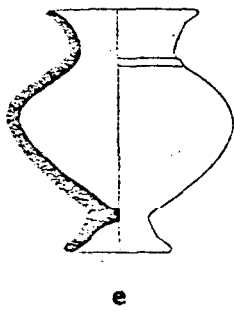
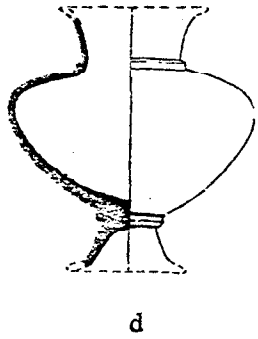
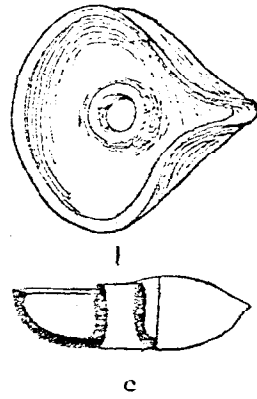
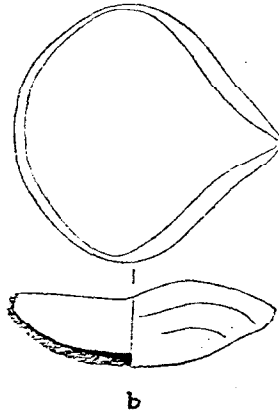
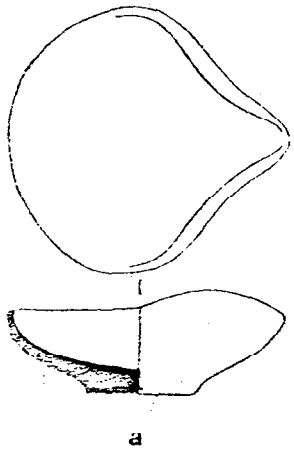

Fig. 448.--Jericho: Selected Pottery from Group v (Cont.)

Kenyon, Jericho II.

a. Fig. 247, No. 14

b. Fig. 247, No. 13.

1692

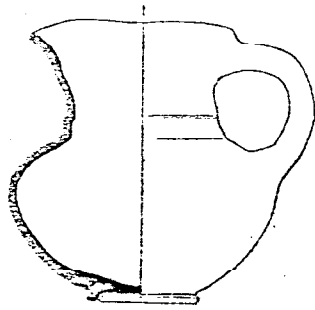

a

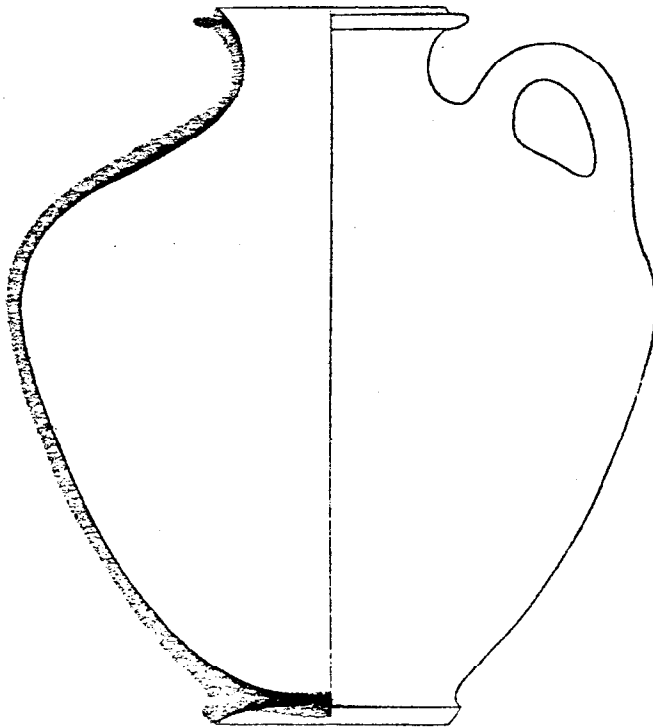

b

Fig. 449.--Jericho: Selected Pottery from Group v (Cont.)

Kenyon, Jericho II.

- a. Fig. 251, No. 17
- b. Fig. 251, No. 15
- c. Fig. 251, No. 13
- d. Fig. 251, No. 16
- e. Fig. 248, No. 7
- f. Fig. 251, No. 10
- g. Fig. 251, No. 9
- h. Fig. 251, No. 8
- i. Fig. 248, No. 6
- j. Fig. 248, No. 1
- k. Fig. 248, No. 8
- l. Fig. 248, No. 9
- m. Fig. 251, No. 18
- n. Fig. 248, No. 3
- o. Fig. 251, No. 12

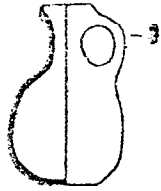

a

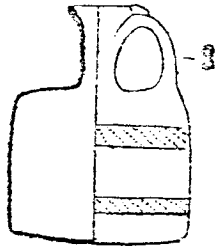

b

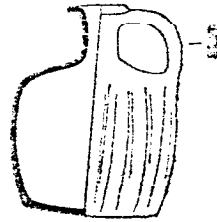

c

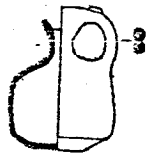

d

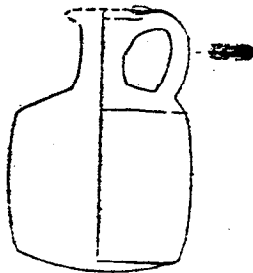

e

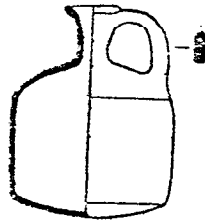

f

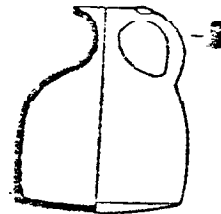

g

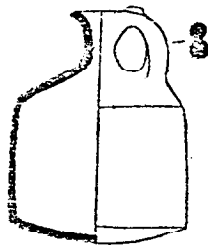

h

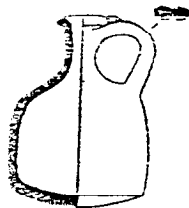

i

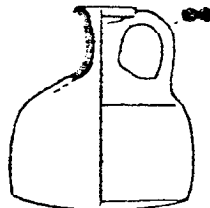

j



k

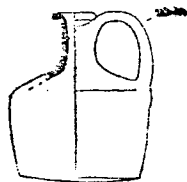

l

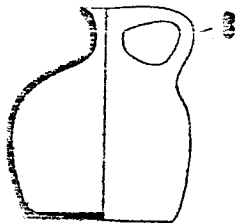

m

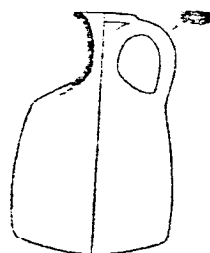

n

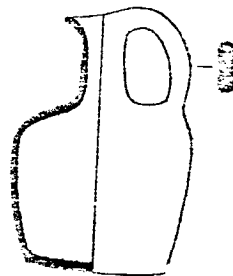

o

Fig. 450.--Jericho: Selected Stone Vessels from Group v

Kenyon, Jericho II.

a. Fig. 238, No. 5

b. Fig. 238, No. 8

c. Fig. 238, No. 4

1696

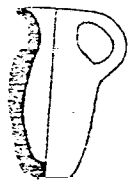

a

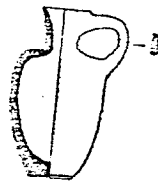

b



c

Fig. 451.--Jericho: Juglets from J14, Phase Uncertain

Kenyon, Jericho II, Fig. 162.

a. No. 2

b. No. 3

c. No. 4

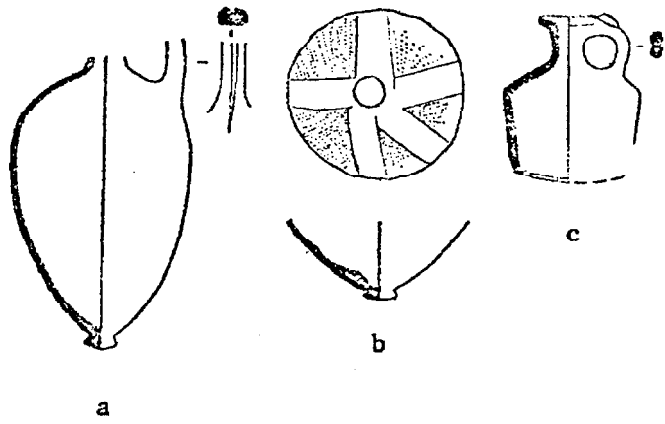

MB III Fig. 452.--Jericho: The "Palace Storerooms"; A House-Block of

Garstang, "Jericho, City and Necropolis, Fourth Report", Plate XV.

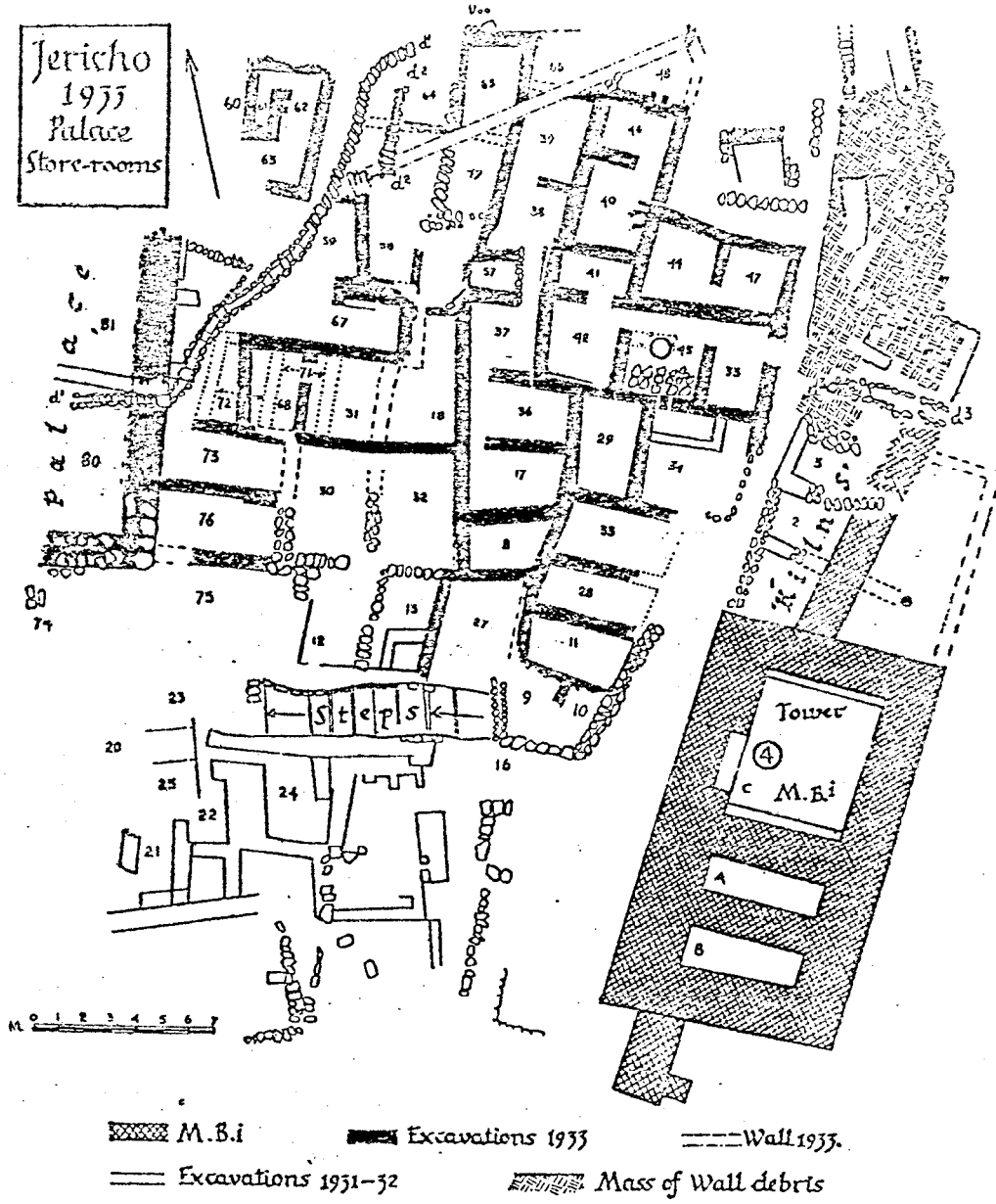

Fig. 453.--Jericho: Pottery from Burials in the Tell and from Squares K6 and I6

Garstang, "Jericho, City and Necropolis, Fourth Report".

a.	Jug	From a MB II C burial in K6	Plate XVII, No. 15
b.	Juglet	From a MB II C burial in K6	Plate XVII, No. 16
c.	Jug	From a MB II C burial in K6	Plate XVII, No. 17
d.	Amphora	From a burial in I6	Plate XVII, No. 20
e.	Juglet	From a burial in I6	Plate XVII, No. 18
f.	Cyl. Juglet	From a burial in I6	Plate XVII, No. 19
g.	K-6		Plate XVII, No. 1
h.	K-6		Plate XVII, No. 10
i.	I-6		Plate XVII, No. 3
j.	I-6		Plate XVII, No. 5
k.	I-6		Plate XVII, No. 6
l.	I-6		Plate XVII, No. 8
m.	I-6		Plate XVII, No. 7
n.	I-6		Plate XVII, No. 11

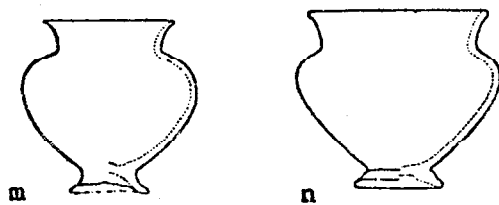
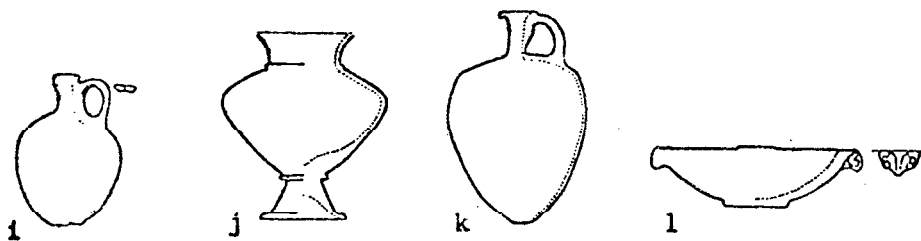
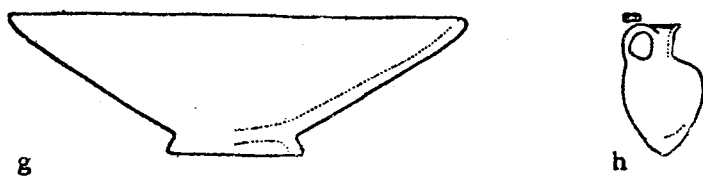
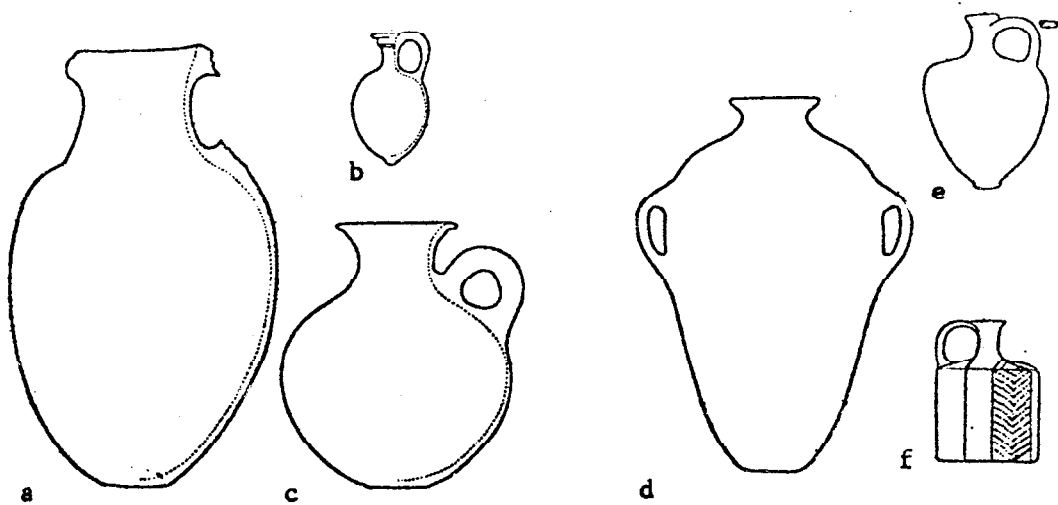

Fig. 454.--Jericho: Pottery from the "Store-rooms"
Kenyon, "Notes on the History of Jericho".

- a. Fig. 5, No. 1 From below store-room floor
- b. Fig. 5, No. 2 Stone, below store-room floor
- c. Fig. 6, No. 2 From Original Store-room floor
- d. Fig. 6, No. 3
- e. Fig. 6, No. 4
- f. Fig. 6, No. 5
- g. Fig. 6, No. 8
- h. Fig. 6, No. 10
- i. Fig. 6, No. 12
- j. Fig. 7, No. 2
- k. Fig. 7, No. 3
- l. Fig. 7, No. 6
- m. Fig. 7, No. 7
- n. Fig. 7, No. 8
- o. Fig. 7, No. 11
- p. Fig. 8, No. 2
- q. Fig. 8, No. 3
- r. Fig. 8, No. 4
- s. Fig. 8, No. 6
- t. Fig. 8, No. 7
- u. Fig. 8, No. 9
- v. Fig. 8, No. 10
- w. Fig. 9, No. 2 From above original floors

