

THE UNIVERSITY OF CHICAGO
ORIENTAL INSTITUTE PUBLICATIONS
VOLUME XCIX

THE UNIVERSITY OF CHICAGO
ORIENTAL INSTITUTE PUBLICATIONS
VOLUME XCIX

INSCRIPTIONS FROM
TELL ABŪ ṢALĀBĪKH

by

ROBERT D. BIGGS

with a chapter by DONALD P. HANSEN



THE UNIVERSITY OF CHICAGO PRESS · CHICAGO & LONDON

International Standard Book Number: 0-226-62202-9
Library of Congress Catalog Card Number: 73-91231

THE UNIVERSITY OF CHICAGO PRESS, CHICAGO 60637
THE UNIVERSITY OF CHICAGO PRESS, LTD., LONDON

© 1974 by the University of Chicago. All rights reserved.
Published 1974. Printed in the United States of America.

To
RICHARD C. HAINES

TABLE OF CONTENTS

| | PAGE |
|---|------|
| LIST OF TEXT FIGURES | ix |
| LIST OF ABBREVIATIONS AND SYMBOLS | xi |
| PREFACE | 1 |
| I. THE STRUCTURAL REMAINS. <i>By Donald P. Hansen</i> | 5 |
| II. INTRODUCTION | 19 |
| III. THE LITERARY AND LEXICAL TEXTS FROM FARA AND TELL ABŪ ṢALĀBĪKH | 28 |
| The Fara Tablets | 28 |
| The Abū Ṣalābīkh Literary and Lexical Texts | 30 |
| The Colophons | 33 |
| Description of Fara Literary and Lexical Texts | 35 |
| IV. THE ADMINISTRATIVE TEXTS | 43 |
| V. TRANSLITERATED TEXTS | 45 |
| The Zà-mì Hymns | 45 |
| The Instructions of Shuruppak | 57 |
| The Names and Professions List | 62 |
| The List of Geographical Names | 71 |
| CATALOGUE OF PUBLISHED TEXTS | 79 |
| INDEX OF FIELD NUMBERS | 98 |
| LIST OF SIGNS AND TERMS DISCUSSED | 110 |
| PLATES | 113 |

LIST OF TEXT FIGURES

| | PAGE |
|--|------|
| 1. PLAN OF LEVELS <i>IA</i> AND <i>IB</i> IN AREA E | 4 |
| 2. THREE BUILDING PHASES IN WALL AND BUTTRESS AT LEVEL <i>IB</i> | 6 |
| 3. CORRIDOR (ROOM 29) | 7 |
| 4. ROOM 39, LEVELS <i>IA</i> , <i>IB</i> , AND <i>IC</i> | 7 |
| 5. ROOM 39, SHOWING SUCCESSIVE FLOOR LEVELS | 8 |
| 6. OUTLINE OF LARGE VESSEL SET INTO FLOOR OF ROOM 39 | 8 |
| 7. LARGE VESSEL SET INTO FLOOR OF ROOM 39 | 9 |
| 8. ROOM 33, PROBABLY USED FOR WASHING | 9 |
| 9. ROOM 31, SHOWING TABLETS IN A CUT | 10 |
| 10. GENERAL VIEW OF EXCAVATIONS IN 1963 | 10 |
| 11. ROOM 7, WITH KITCHEN FIREPLACES | 12 |
| 12. PAVEMENT OF BAKED BRICKS WITH DRAIN IN ROOM 6 | 12 |
| 13. VIEW OF COURTYARD, WITH BITUMEN-COATED RUNNERS | 14 |
| 14. ROOM 22, WHERE COURTYARD RUNNERS LED | 14 |
| 15. ROOM 3, WITH BITUMEN-COATED DOORWAY TO COURTYARD | 15 |
| 16. GENERAL VIEW OF ROOM 9, SHOWING ROBBERS' HOLES | 15 |
| 17. ROOM 9, SHOWING THREE SERIES OF FLOORS | 16 |
| 18. ROOM 18, SHOWING DOOR SOCKETS | 16 |
| 19. KILN IN ROOM 25 | 17 |
| 20. TEXT No. 253 DISTORTED BY SALT CRYSTALS | 20 |
| 21. EXCAVATION OF HOARD OF TABLETS IN ROOM 31 | 20 |
| 22. HOARD OF TABLETS NEAR END OF EXCAVATION | 21 |
| 23. DETAIL SHOWING FIELD TREATMENT OF TABLET | 21 |
| 24. UNDERSIDE OF SURFACE LAYERS OF TABLETS | 23 |
| 25. ELEMENTARY PUPIL'S CRUMPLED WRITING EXERCISE | 24 |
| 26. IMPRESSION OF TEXTILE AND STRING (<i>A</i>) AND MARK MADE WITH STYLUS (<i>B</i>) | 26 |
| 27. DESIGN COPIED FROM FRAGMENTARY TABLET | 30 |
| 28. DESIGN FROM No. 47 | 30 |
| 29. REVERSE OF No. 2 | 31 |
| 30. INSTRUCTIONS OF SHURUPPAK | 58 |

LIST OF ABBREVIATIONS AND SYMBOLS

- A** lexical series á A = *náqu*.
- AbS** prefix of Abū Šalābīkh field numbers.
- AbS-T** prefix of Abū Šalābīkh tablet field numbers.
- Bi.Or.** Bibliotheca Orientalis (Leiden, 1943—).
- CAD** The Assyrian Dictionary of the Oriental Institute of the University of Chicago (11 vols. to date; Chicago and Glückstadt, 1956—).
- CT** Cuneiform Texts from Babylonian Tablets . . . in the British Museum (51 vols. to date; London, 1896—).
- Diri** lexical series diri DIR *siāku* = (*w*)*atru*.
- Erimhuš** lexical series erimhuš = *anantu*.
- Fara II** Anton Deimel. Die Inschriften von Fara, Vol. II: Schultexte aus Fara. Deutsche Orient-Gesellschaft, Berlin. Wissenschaftliche Veröffentlichungen, Vol. XLIII (Leipzig, 1923).
- Fara III** Anton Deimel. Die Inschriften von Fara, Vol. III: Wirtschaftstexte aus Fara. Deutsche Orient-Gesellschaft, Berlin. Wissenschaftliche Veröffentlichungen, Vol. XLV (Leipzig, 1924).
- IAS** prefix of texts published in this volume.
- Igituh** lexical series igituh = *tāmartu*.
- ITT** F. Thureau-Dangin, *et al.* Inventaire des tablettes de Tello conservées au Musée Impérial Ottoman (5 vols.; Paris, 1910–21).
- JCS** Journal of Cuneiform Studies (New Haven, 1947—).
- JNES** Journal of Near Eastern Studies (Chicago, 1942—).
- KAR** Erich Ebeling. Keilschrifttexte aus Assur religiösen Inhalts (Leipzig, 1915–23).
- LAK** Anton Deimel. Die Inschriften von Fara, Vol. I: Liste der archaischen Keilschriftzeichen. Deutsche Orient-Gesellschaft, Berlin. Wissenschaftliche Veröffentlichungen, Vol. XL (Leipzig, 1922).
- LAK** prefix of signs appearing in *LAK*.
- MAD** Materials for the Assyrian Dictionary (Chicago, 1952—).
- MAD No. 2** I. J. Gelb. Old Akkadian Writing and Grammar. Materials for the Assyrian Dictionary, No. 2 (2d ed.; Chicago, 1961).
- MAD No. 3.** I. J. Gelb. Glossary of Old Akkadian. Materials for the Assyrian Dictionary, No. 3 (Chicago, 1957).
- MAD No. 4.** I. J. Gelb. Sargonic Texts in the Louvre Museum. Materials for the Assyrian Dictionary, No. 4 (Chicago, 1970).
- MAD No. 5** I. J. Gelb. Sargonic Texts in the Ashmolean Museum, Oxford. Materials for the Assyrian Dictionary, No. 5 (Chicago, 1970).
- MBI** George A. Barton. Miscellaneous Babylonian Inscriptions (New Haven, 1918).
- MSL** Benno Landsberger, *et al.* Materials for the Sumerian Lexicon (14 vols. to date; Rome, 1937—).
- NTSŠ** Raymond R. Jestin. Nouvelles tablettes sumériennes de Šuruppak au Musée d'Istanbul (Paris, 1957).
- NTSŠ** prefix of tablets appearing in *NTSŠ*.

| | |
|----------------|--|
| obv. | obverse. |
| <i>OECT</i> | Oxford Editions of Cuneiform Texts (8 vols.; Oxford, 1923–30). |
| <i>OIP</i> | Oriental Institute Publications (Chicago, 1924—). |
| <i>OIP XIV</i> | Daniel David Luckenbill. Cuneiform Series, Vol. II: Inscriptions from Adab. Oriental Institute Publications, Vol. XIV (Chicago, 1930). |
| Proto-Diri | <i>see</i> Diri. |
| <i>R</i> | H. C. Rawlinson. The Cuneiform Inscriptions of Western Asia (5 vols.; London, 1861–84). |
| <i>2R</i> | H. C. Rawlinson. A Selection from the Miscellaneous Inscriptions of Assyria (London, 1866), Vol. II of The Cuneiform Inscriptions of Western Asia. |
| <i>RA</i> | Revue d'assyriologie (Paris, 1884—). |
| rev. | reverse. |
| <i>SF</i> | prefix of tablets appearing in <i>Fara II</i> . |
| Š | siglum for tablets from Shuruppak in the Archeological Museum, Istanbul. |
| <i>TCS</i> | Texts from Cuneiform Sources (Locust Valley, N.Y., 1966—). |
| <i>TCS III</i> | Åke Sjöberg and E. Bergmann. The Collection of Sumerian Temple Hymns. Texts from Cuneiform Sources, Vol. III (Locust Valley, N.Y., 1969). |
| <i>TŠŠ</i> | Raymond R. Jestin. Tablettes sumériennes de Šuruppak conservées au Musée de Stamboul (Paris, 1937). |
| <i>TŠŠ</i> | prefix of tablets appearing in <i>TŠŠ</i> . |
| <i>UET</i> | Ur Excavations, Texts. Publications of the Joint Expedition of the British Museum and of the Museum of the University of Pennsylvania to Mesopotamia (6 vols. to date; London, 1928—). |
| <i>VAS</i> | Vorderasiatische Schriftdenkmäler der Königlichen Museen zu Berlin (Leipzig, 1907–17). |
| <i>VAS II</i> | Heinrich Zimmern. Sumerische Kulteiler aus altbabylonischer Zeit. Vorderasiatische Schriftdenkmäler der Königlichen Museen zu Berlin, Vol. II (Leipzig, 1912). |
| <i>VAS XIV</i> | Wilhelm Förtisch. Altbabylonische Wirtschaftstexte aus der Zeit Lugalanda's und Urukagina's. Vorderasiatische Schriftdenkmäler der Königlichen Museen zu Berlin, Vol. XIV (Leipzig, 1916). |
| <i>WF</i> | prefix of tablets appearing in <i>Fara III</i> . |
| <i>ZA</i> | Zeitschrift für Assyriologie (Leipzig and Berlin, 1886—). |
| x | represents an illegible sign; (x) within square brackets indicates a sign which may or may not have been present. |
| x | represents a sign of unknown or uncertain reading. |
| [] | indicates destroyed text. |
| ┘ | indicates damaged sign or signs. |
| < > | indicates scribal omission. |
| << >> | indicates un erased scribal error. |
| + | indicates fragments of tablets joined after cataloguing. |
| (+) | indicates fragments which belong to the same tablet but do not join directly. |
| * | indicates dubious traditional interpretation of sign. |

PREFACE

IN THIS volume are published all of the cuneiform tablets excavated at Tell Abū Ṣalābīkh in 1963 and 1965 with the exception of a very few fragments considered illegible or utterly worthless. All other tablets are represented by a copy, by a photograph, or by both.¹

When I began copying the texts in 1965, I was unaware of the enormity and complexity of the task that lay ahead. Had I suspected that the preparation of this volume would occupy the major portion of my free time for seven years, I doubt that I would have chosen to present the entire material in a single volume. Publication of a large number of the tablets in photograph was considered, but the idea was rejected, partly because of the high cost of such a publication. A more important consideration was that in my opinion the long-term needs of scholarship would not be well served by publication in photograph only, since many of the tablets were damaged and difficult to read and would have been fully accessible only to scholars who were both experienced in reading from photographs and thoroughly familiar with the script. It is my hope that the format I have chosen will make the entire corpus readily accessible even to scholars with limited experience in third-millennium cuneiform handwriting.

Except for the copies of especially fragile tablets made in the field, preliminary copies were prepared from casts and photographs. Subsequently they were checked against the original tablets in the Iraq Museum. In the case of a few unusually difficult tablets, the copy published here is the last of several efforts, each of which was checked against the original in Baghdad and subsequently copied anew. Except in a few instances when a tablet was unavailable (being exhibited in a museum in another part of Iraq, for example), I have personally collated all copies against the originals at least once; exceptions are explicitly mentioned in the Catalogue of Published Texts.

All fragments have been given separate publication numbers, even when there was no doubt about specific fragments belonging to the same tablet. Without doubt, a number of joins can still be made among the tablets. I believe this is particularly true of the group I have called UD.GAL.NUN. These tablets, published here as Nos. 112–254, are so numerous that, without preparation of transliterations and detailed textual studies, it is probable that relatively few of the fragments can be rejoined. A considerable number of joins were made in the field, where it was possible to lay out all the tablets of this genre in a large room, but I have had no opportunity to attempt joins in this fashion since that time.

Except for stratigraphically early texts, the tablets were chosen to be published in photograph largely on the basis of legibility; unless the text could be read easily from a photograph, it did not seem either useful or fair to publish it only in photograph. In addition, some tablets are published in photograph to illustrate the standard handwriting of the Abū Ṣalābīkh scribes; tablets which differ markedly from this norm are also published in photograph. It goes almost

1. Since the Standard Professions List is now known from a number of copies, it seemed of limited value to publish all the new tablets and fragments individually. Therefore, a composite copy, representing all of the Abū Ṣalābīkh sources, is given here as text No. 1.

without saying that serious paleographical studies should be based primarily on the photographs rather than the copies.

To avoid further delay in the publication of this volume, I have not included a sign list. I feel that publication of such a list would be justified only if it also included the specific evidence for readings and identifications of signs. I have not yet utilized the texts in this volume sufficiently in depth or with sufficient understanding to make a contribution of this nature at the present time. I have nevertheless had occasion to discuss a number of specific problems in earlier publications and in this volume. These signs are given below in the List of Signs and Terms Discussed. Nevertheless, for persons not wholly familiar with the script, the texts presented in this volume in transliteration may be of help.

To avoid possible confusion, I have omitted "No." in citing all texts except those published in this volume. Occasionally, when it seemed that an Abū Ṣalābīkh text might be confused with a text from another publication, I have used the abbreviation IAS (for Inscriptions from Tell Abū Ṣalābīkh) before the text number. Fara texts are cited by using the abbreviations TSS, NTSS, SF (for texts published in *Fara II*), and WF (for those published in *Fara III*).

It is a pleasure to record here my indebtedness to a number of persons who have been helpful to me in the long process of preparing this volume. The tablets of the first season (AbS-T 1-94) were baked, cleaned, and photographed by Dr. Vaughn E. Crawford. I owe a great debt to Miss Selma al-Radi, who worked with me for many weeks during the process of baking, cleaning, and conserving the tablets from the second season. Mr. McGuire Gibson helped to reassemble several of the larger tablets after initial conservation. I am very grateful to him for the weeks he spent in Baghdad in the summer of 1965 photographing the tablets. These photographs were a major help in preparing the copies. Miss Diane E. Taylor gave valuable assistance in making joins, and Mr. James E. Knudstad prepared hundreds of molds which were used to produce the casts now at the Oriental Institute. I am grateful to Miss Taylor for lending me the slide from which Fig. 23 was made. I am much indebted to Mrs. Ursula Schneider, Oriental Institute photographer, for making the hundreds of prints needed for the preparation of this volume. I also wish to thank Mrs. Jean Eckenfels, Oriental Institute Editorial Secretary, for the attention she has given the manuscript of this volume. She detected a number of errors and made many suggestions for improvement.

The Directorate General of Antiquities has been most helpful at every stage of our work, both under the directorship of Dr. Faisal al-Waily and his successor, Dr. Isa Salman. Dr. Faraj Basmachi, Director of the Iraq Museum, greatly facilitated the work of taking photographs of the tablets after our return to Baghdad. His successor, Dr. Fauzi Rachid, has been equally helpful to me during each of my visits to the Iraq Museum. Dr. Abdul Hadi al-Fouadi has been of great assistance in helping to verify museum accession numbers; he has very kindly checked a number of suspected joins for me subsequently and has promptly replied to requests for collations. Dr. Behijah Khalil was a great help in locating the tablets I requested. Thanks to them and to other colleagues in the Directorate General of Antiquities, my work in the Iraq Museum has always been a special pleasure.

I am grateful to Professor Miguel Civil for reading the manuscript for this volume. It has benefited considerably from his corrections and suggestions. Miss Judith Franke has likewise read the manuscript, asked pertinent questions, and given me valuable suggestions for improving the clarity of my presentation.

Excavations both in 1963 and 1965 were directed by Dr. Donald P. Hansen. Dr. Vaughn E. Crawford was a member of the expedition staff in 1963. I was epigrapher in both 1963 and 1965. Miss Diane E. Taylor was a member of the staff in 1965. The Directorate General of Antiquities was represented in the two seasons by Mr. 'Awad al-Kassar and Miss Selma al-Radi,

PREFACE

3

respectively. We were much indebted to both of them for their help and participation in our work.

Mr. and Mrs. James E. Akins and Mr. and Mrs. Hans J. Bielefeldt of Baghdad were special friends of the expedition during both seasons, not only visiting us often at the site but also providing generous hospitality to us during our stays in Baghdad.

ROBERT D. BIGGS

CHICAGO
June 1973

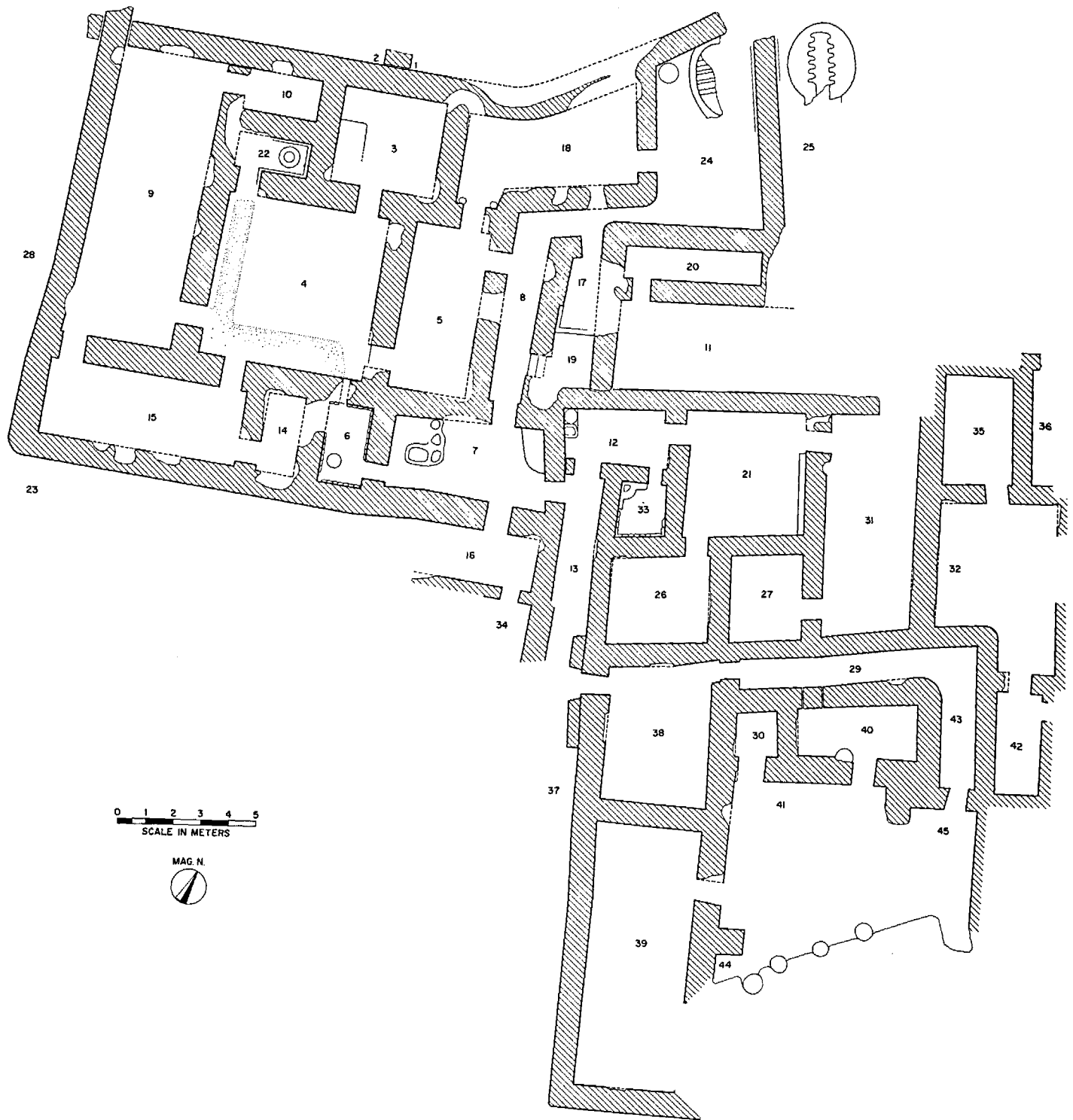

FIG. 1.—PLAN OF LEVELS IA AND IB IN AREA E

I

THE STRUCTURAL REMAINS

By DONALD P. HANSEN

Two brief soundings, six weeks in the spring of 1963 and two weeks in the winter of 1965, were undertaken by the Oriental Institute at Tell Abū Ṣalābīkh in southern Iraq. The site lies approximately 12 miles northwest of the important city of Nippur and was undoubtedly linked to it in antiquity by the Euphrates or a major canal.¹ The ancient name of Tell Abū Ṣalābīkh is not known, although there has been an attempt to identify the site with the name of a city mentioned in ancient texts.²

Tell Abū Ṣalābīkh is not an exceptionally large site. Its length is slightly less than 900 meters, and its greatest width is approximately 850 meters. The site is composed of three mounds: a long one, on the east, and two smaller ones to the west. The east and west areas are separated by a low depression which is probably the ancient bed of the river or canal which cut through the city. On the western side of the tell occupation began in the Uruk period and lasted into the Jamdat Nasr period, when the area was abandoned. One sounding (Area A) on the eastern mound indicated that occupation there began with Early Dynastic I, but a great many clay cones predating the Early Dynastic period found on the surface near the foot of the eastern mound suggest that there was some occupation on the eastern side prior to Early Dynastic I. In any case, the period of the most extensive occupation on the eastern side was the Early Dynastic period. Occupation ceased at the end of Early Dynastic IIIA or shortly thereafter, and the site was never reoccupied.

The tablets were found in buildings on the eastern mound, in Area E. This area is at the highest part of the mound, slightly north of center, and it was investigated during both seasons of the excavations. This chapter is intended to give only an indication of the nature of the buildings so that the tablets are provided with an archeological context.

At least two buildings were found in Area E, but neither could be fully investigated in the short period of our excavation. Both buildings suffered from ancient cuts as well as from many holes made by modern robbers. It is not clear when these holes were made, or what the robbers found or hoped to find. Since the tablets found by the expedition were nearly all unbaked and very fragile, it is doubtful that robbers could have removed similar tablets even partially intact. Furthermore, to our knowledge no group of texts of this period of unknown provenience is in any museum collection.

The structural remains of the buildings for two phases, designated Levels *IA* and *IB*, are combined in plan (Fig. 1). In many areas of the excavation Level *IA* was not preserved. Rooms 29, 30, 38–41, and 43–45, in the southern part of the excavation, apparently form one architectural unit.³

1. T. Jacobsen, "The Waters of Ur," *Iraq* XXII (1960) Pl. 28.

2. See ch. 2.

3. Since all tablets were found in Area E, the area designation has been omitted from findspots in this chapter and in the Index of Field Numbers.

Access to this southern unit is by means of a door located in the corridor designated as rooms 13 and 37. The entrance is marked by two buttresses of unequal size, which were not bonded to the main wall. The south buttress and wall show three phases of occupation indicated by a rebuilding and repair in the earlier Level *IB*. The wall and buttress of Level *IB* were cut down and repaired (Fig. 2). The repair was rather crudely done with large mud bricks packed into the cut made in the wall. In the buttress itself mud bricks of various sizes were used as well as fragments of baked brick. The Level *IA* rebuilding is separated from this crude repair by mud plaster 5 centimeters thick. The north buttress does not have the intermediate repair, and so there only two phases are represented.



FIG. 2.—THREE BUILDING PHASES IN THE SOUTH WALL AND BUTTRESS AT ENTRANCE TO THE SOUTHERN UNIT AT LEVEL *IB*

From the vestibule or entrance (room 38), where a tablet was found in the fill of Level *IB*, circulation to the central courtyard was through the corridor (rooms 29 and 43, Fig. 3). Only part of the north wall foundation of the corridor at Level *IA* was preserved. Originally a door from room 29 opened into room 40, but this was blocked early with baked plano-convex bricks laid in the typical herringbone pattern. A few of the bricks were rectangular in shape and not plano-convex. A disturbed burial was found in a late cut in the debris which filled the corridor (room 43).

The courtyard (rooms 41, 44, and 45) was filled with many ashy strata. In the plan (Fig. 1) the circles at the south edge of the excavation represent ovens and firepits high up in the debris. These were in use after the building was abandoned and probably account for the ashy debris in the courtyard. In the northwest corner of room 44 several fragmentary tablets were found at Level *IC*, floor 2, on a finely plastered floor of the type one usually associates with temples. These tablets are the earliest of the sequence of Fara-type texts from Tell Abū Ṣalābīkh.



FIG. 3.—ENTRANCE TO CORRIDOR (ROOM 29) IN SOUTHERN UNIT, LOOKING EAST



FIG. 4.—ROOM 39, SHOWING SEQUENCE OF PHASES, LEVELS IA, IB, AND IC



FIG. 5.—DETAIL IN ROOM 39 SHOWING ACCUMULATION OF FLOORS AND FILL



FIG. 6.—OUTLINE OF LARGE VESSEL SET INTO THE FLOOR OF ROOM 39 AT LEVEL IB

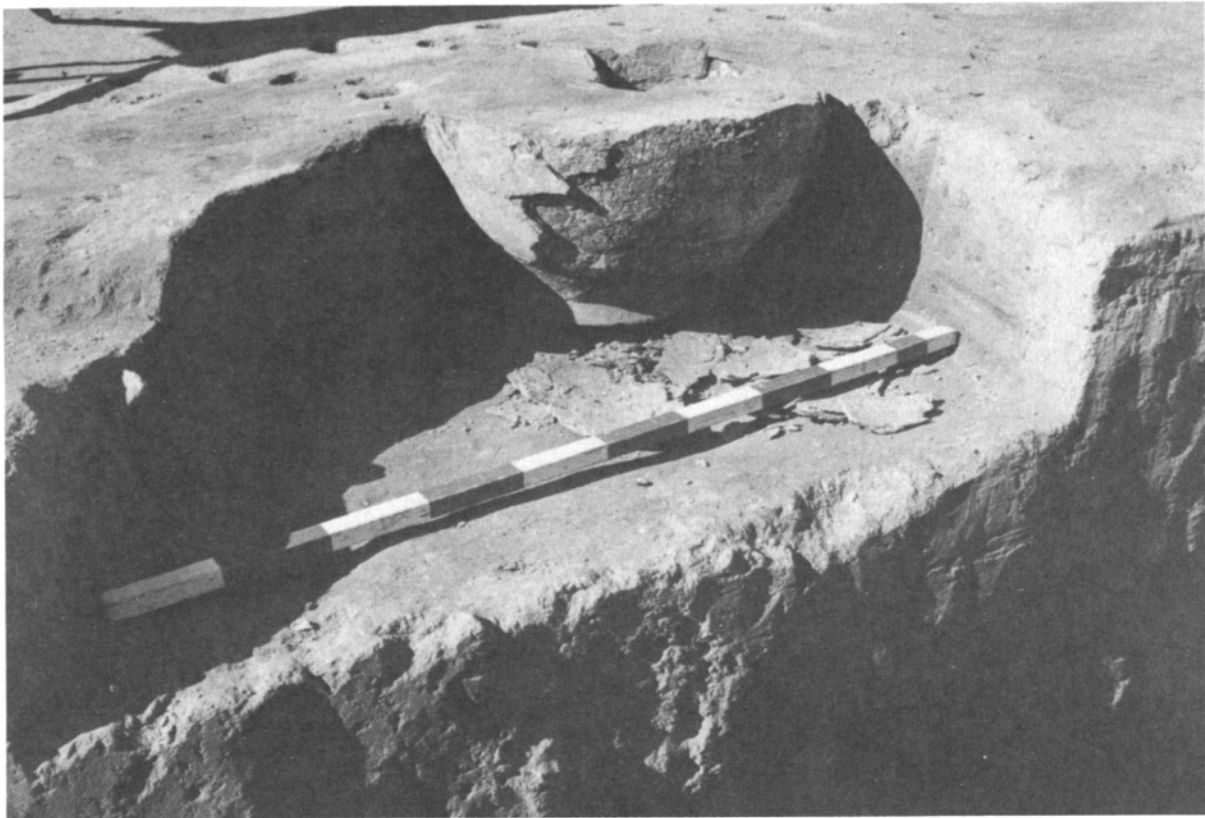

FIG. 7.—PARTIALLY EXCAVATED BOWL WITH RING BASE SET INTO FLOOR OF ROOM 39



FIG. 8.—ROOM 33, PROBABLY USED FOR WASHING, SHOWING DAMP COURSE AND SUNKEN RECEPTACLE FOR WATER IN THE CORNER PLATFORM ON THE RIGHT



FIG. 9.—THE LARGE HOARD OF TABLETS IN ROOM 31 FOUND IN A CUT AT LEVEL IB DURING THE SECOND SEASON



FIG. 10.—GENERAL VIEW OF EXCAVATIONS IN 1963, SHOWING MOST OF THE BURNED BUILDING, LOOKING NORTH

Room 39 was the largest and therefore probably the most important in the southern unit. Access to room 39 was through a door in the western wall of the courtyard. When the buttressed doorway was found at the entrance, it seemed that the southern unit might be a temple and room 39 a cella with the characteristic bent-axis approach, but the absence of a niche or altar against the south wall of room 39 suggested that this view was erroneous. The sequence of levels here is divided into three phases, Levels IA, IB, and IC (see Fig. 4). Only a few courses of bricks at Level IA are preserved. The face of the upper part of the Level IB wall was cut away but was preserved at the floor, a portion of which can be seen on the right. Below this are the two partially cleared floors of Level IC. The lowest floor, floor 2, corresponds to the floor in the courtyard where the earliest tablets were found. An early tablet appeared in the fill of the same level in room 39 to the south of the door. The accumulation of floors and fill in the room is well illustrated in Fig. 5. In the foreground on the left is a large robbers' hole which was cut down from the surface. To the right, located on floor 2 of Level IC were three unbaked clay objects which showed evidence of burning. They may have been used as a tripod to support a light vessel. Similar clay objects were found in "House D" of the Temple Oval at Khafajah.⁴

In the central part of the room at Level IB a large bowl with ring base was set into the floor (Figs. 6 and 7). At the bottom of the pot was a thick layer of black ash. There were circular red burned areas to the north and south of the pot. A series of post holes(?) without any apparent pattern was found near the firing places. The holes ranged in size from 2 to 5 cm. in diameter and were 2 to 13 cm. deep. They all tapered to a point, and most were filled with brown ashy earth. Their use is uncertain. The central part of the room has not been excavated down to Level IC.

To the north is a central group of rooms which are structurally connected with this southern unit as well as with part of the burned building to the northwest, which was excavated in 1963. These rooms are 12, 13, 21, 26, 27, 31-33, 35, 36, and 42. The means of access from these rooms into the burned building is clear, but it is not known whether room 42 was also connected to the east side of the southern unit.

There was a 15-cm. step down from the corridor (room 13) into room 12. Since room 12 contained a circular oven as well as a fireplace, one may assume that this small room was not roofed. The next room to the south, room 33, was used for washing, and traces of bitumen were preserved on the floor of Level IB, suggesting that the entire floor was once paved (Fig. 8). A partially preserved dado or damp course of plano-convex bricks placed on edge originally protected three walls of the room. In the northwest corner was an irregular-shaped platform with a sunken receptacle for water. A drain passed through the west wall and emptied into the corridor (room 13).

Room 21, to the east, was extensively destroyed by large cuts from the surface and from Level IA. In one such cut were found most of the tablets discovered during the first season.

Most of the tablets of the second season were found in the adjoining room 31, which was severely burned. It was definitely roofed, for part of a burned wooden beam was discovered. Again there were extensive holes and cuts in this room. All the tablets found at Level IB were in cuts or in fill. None were found on a preserved floor. The large hoard is shown in Fig. 9, where the outline of the cut is visible. This cut clearly came from Level IA; however, there is no evidence to suggest that it did not post-date Level IA as well. The tablets were found in a very delicate condition with some burned matting, potsherds, fragments of bitumen, and fish bones in the earth around and between the tablets.

This central group of rooms connects with the burned building (Fig. 10) to the northwest through room 7, which was a kitchen. A southern doorway in room 7 connected with the corridor

4. P. Delougaz, *The Temple Oval at Khafajah* (OIP LIII [Chicago, 1940]) p. 53, Fig. 51.

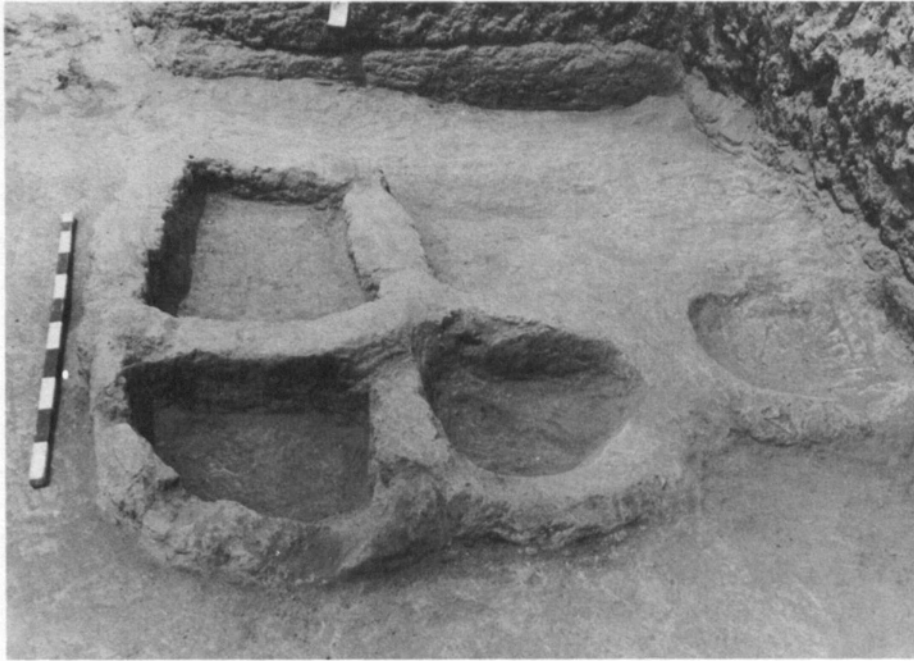

FIG. 11.—FIREPLACES GROUPED IN THE KITCHEN
(ROOM 7) OF THE BURNED BUILDING



FIG. 12.—ROOM 6, SHOWING BAKED-BRICK DRAIN, PAVING, AND DAMP COURSE

(room 16). The debris in this corridor, like that commonly found in streets, was heavily striated. The main entrance to the building, however, was probably located in the unexcavated area to the northeast. The fireplaces of the kitchen were made of mud with the occasional addition of some mud brick (Fig. 11). The floor showed extensive signs of burning. The furniture in the room consisted of a low bench fitted into the northeast corner of the room.

To the west of the kitchen was room 6, the "bath" (Fig. 12). Like most rooms of the building, the remains suffered from cuts through the walls and floors. The floor was paved with baked plano-convex bricks on top of which was the usual mud-plaster floor. Ten centimeters above the floor a baked tablet (No. 494) was found. Like room 33, this bath had a dado formed of baked plano-convex bricks placed on edge. In the drain set in the southern part of the room there was a round copper vessel which probably fell into the drain when the building was abandoned. A bitumen-lined watercourse passed from the north wall of the room into the central courtyard (room 4).

The courtyard, with its heavily burned but badly cut walls and floors, had bitumen runners on the south and west sides (Fig. 13). The west strip of bitumen led to room 22, another small room for washing (Fig. 14). This room was paved with bitumen and had a low dado at the base of the wall constructed of mud plaster covered with bitumen. A bitumen-lined depression in the floor served as the receptacle for the water, but there was apparently no drainage system to remove the used water from the room.

Bitumen was also used on the floor of the doorway connecting the central courtyard and room 3 (Fig. 15). It was placed over a pavement of broken baked bricks. There was a 15-cm. step down to the first floor. The distinguishing feature of room 3 was a low platform, only partially preserved, constructed against the west wall. It was 12 cm. high and edged with bitumen. The traces remaining on top of the platform suggested that it was also originally covered with bitumen. Nothing was found in the room which suggested the function of the bench or platform. It seems too low to have been a shrine. Only a terra-cotta ring and a fragmentary miniature stone bowl appeared during the course of excavation, but these were in the fill and not on the floor. Seven fragmentary tablets (Nos. 1, 460, 493, 498-500, and AbS-T 6 [unpublished]) also came from the fill.

Room 9 was the largest room in the residence, but it had no distinctive features. The room was less than 4 m. wide and could well have been roofed. There was extensive damage done to the floors and walls by the robbers' holes and ancient cuts (Fig. 16). A fragment of a tablet (No. 82) came from one of the cuts. A small sounding in the northwest corner of the room indicated that there were three series of floors in the building (Fig. 17). The lower floors were not excavated.

The south door of the irregular-shaped room 18 had the only door sockets which were preserved in the building. At the time of occupation of the earliest floor the socket was placed next to the east jamb. It was moved to the west side when a second, later, floor was constructed (Fig. 18).

Rooms 11, 17, 19, 20, 24, and 25 were not well preserved, and it became difficult to understand the various phases of the construction. The plan (Fig. 1) is simplified for these rooms. It was clear that a staircase existed between the corridor (room 8) and room(?) 19. It was not possible to determine how this staircase functioned. Room 17 was another washing area provided with a bitumen-lined depression in the floor. Room 20 was a small narrow room. A great many of the tablet fragments excavated during the first season came from the debris in this chamber. In rooms 24 and 25 (Fig. 19) were two kilns. An oven was placed in the corner of the room beside the kiln of room 24. The building evidently continued to the east in a somewhat haphazard manner, but it was clear that Level I had been mostly destroyed, and therefore the area was not excavated. The main entrance may well have been located in this eastern part.

The only tablets which were found in a stratified context were those from the courtyard (room 44) and the one from room 39 in the southern unit. The rest are from fill and cuts made in



FIG. 13.—VIEW OF THE COURTYARD (ROOM 4), WITH BITUMEN-COATED RUNNERS ON THE SOUTH AND WEST SIDE



FIG. 14.—ROOM 22, WITH BITUMEN-COATED RUNNER BEYOND THE DOORWAY INTO COURTYARD 4, LOOKING SOUTH



FIG. 15.—ROOM 3, WITH BITUMEN-COATED DOORWAY TO THE COURTYARD (ROOM 4)
ON THE LEFT AND LOW PLATFORM AGAINST THE WEST WALL



FIG. 16.—GENERAL VIEW OF ROOM 9 SHOWING EXTENT OF ROBBERS' HOLES AND ANCIENT PITS



FIG. 17.—SMALL SOUNDING IN NORTHWEST CORNER OF ROOM 9
SHOWING THREE SERIES OF FLOORS



FIG. 18.—ROOM 18 (FOREGROUND) SHOWING DOOR SOCKETS ON
OPPOSITE SIDES OF THE DOOR IN TWO OCCUPATIONAL
LEVELS, LOOKING SOUTH

antiquity. The stratified texts date the building to the time of the Fara tablets, which have been traditionally assigned to Early Dynastic IIIA. According to R. Biggs, there are few differences between the earliest tablets and the later ones from Level IA or even later, for example, the hoard in room 31, beyond the usual scribal peculiarities.⁵ Since there are several architectural levels of the buildings, it may well be that the writing stage of the "Fara texts" covered a relatively long period of time.

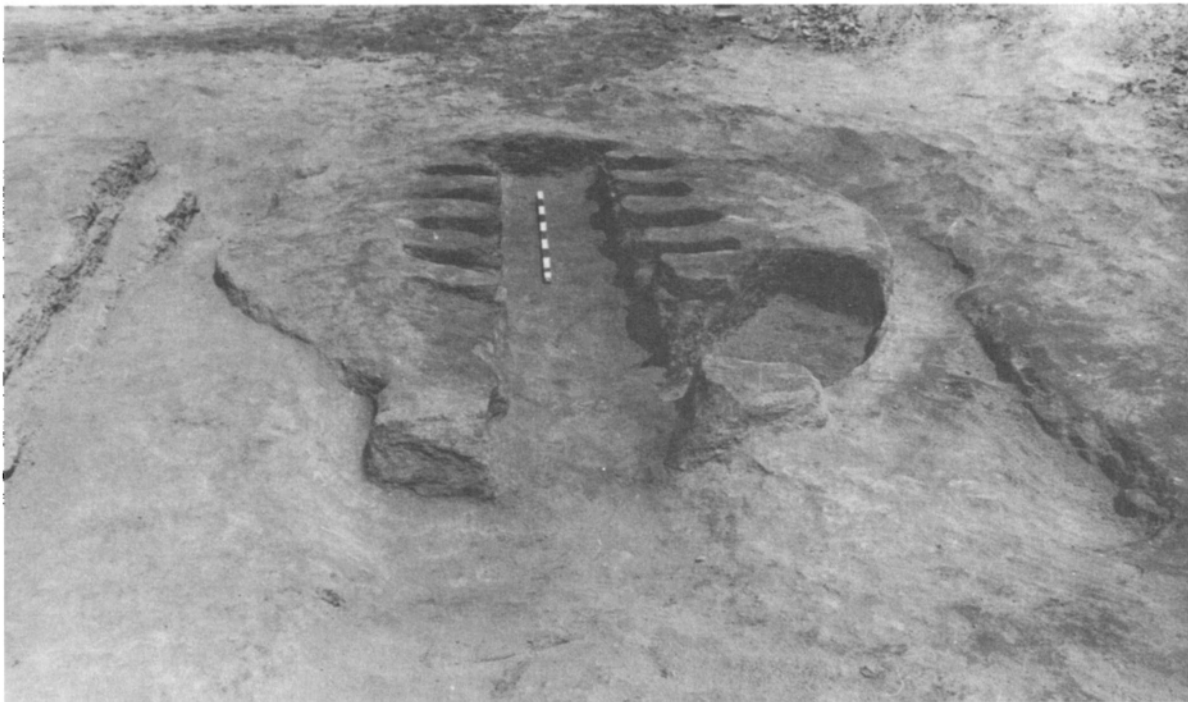

FIG. 19.—KILN IN ROOM 25, LOOKING NORTH

Aside from the tablets, nothing found in the buildings gives an indication of the exact function of the structures; however, there are striking parallels with other Sumerian buildings. For example, the southern unit has an entrance vestibule (room 38) and a long corridor (rooms 29 and 43) leading to the central courtyard, which has surrounding rooms. This plan is clearly related to the plan of "House D" in the Temple Oval at Khafajah,⁶ which, interestingly enough, provided the parallels for the clay objects found in room 39 (Fig. 5). In the original plan of "House D" there is a similar vestibule, long corridor, central courtyard, and surrounding rooms. The main room K 43:3 would be the equivalent of our room 39. An important feature of "House D" was the shrine, L 43:4. No clear evidence of a shrine appeared in the southern unit; however, the building was not fully excavated. A somewhat similar arrangement exists in the southern part of the main level of the Shara Temple at Tell Agrab.⁷ Here there is a long corridor leading into a washing room from which there is access to the main part of the building.

House XIII f at Fara has a comparable plan with the entrance vestibule and long corridor leading into the central courtyard.⁸ This building, also only partially excavated, yielded many of the texts contemporary with those from Tell Abū Ṣalābīkh.

5. See below, pp. 25–26.

6. Delougaz, *The Temple Oval*, pp. 44–45 and Pl. 4; also Fig. 47.

7. P. Delougaz and S. Lloyd, *Pre-Sargonic Temples in the Diyala Region* (OIP LVIII [Chicago, 1942]) Pl. 26. Delougaz

discusses the relationship between the temple and "House D" on pp. 261–65.

8. E. Heinrich, *Fara, Ergebnisse der Ausgrabungen der Deutschen Orient-Gesellschaft in Fara und Abu Hatab, 1902/03* (Berlin, 1931) p. 14, Fig. 12.

The distinctive corridor leading to the courtyard is apparently lacking in the burned building at Tell Abū Ṣalābīkh. The plan of the eastern portion of the building is certainly circuitous, and since the remains are difficult to interpret, the circulation remains unclear. The basic form of the building—a central courtyard with surrounding large and small rooms—may be compared with such building plans as the Square Abu Temple at Tell Asmar,⁹ or again with the more elaborate portion of the southern part of the main level of the Shara Temple.¹⁰

Delougaz has suggested that “House D” in the Temple Oval was “the residence of a person of high rank connected with the temple, probably its high priest,” and goes on to suggest that this may well be true for the southern rooms of the Shara Temple.¹¹ The Tell Abū Ṣalābīkh buildings may be interpreted in a similar fashion. They are probably the residential or administrative dependencies of a temple which is yet to be found in the immediate vicinity of Area E.¹²

9. Delougaz and Lloyd, *Pre-Sargonid Temples*, p. 176, Fig. 133.

10. *Ibid.*, Pl. 26.

11. *Ibid.*, p. 262.

12. See also the comments of Biggs, in ch. 4 below.

II

INTRODUCTION

THE first tablet found at Tell Abū Ṣalābīkh was discovered early in the first season, but it was only after several weeks of soaking and scrubbing that it was possible to see that it was inscribed in cuneiform, for the thick layer of hard salts which may form on baked tablets was unusually thick and hard in this instance. Several other baked tablets discovered later were equally salt-encrusted. Unfortunately, very few of the tablets were baked in antiquity, for had they been, they would have come to us in a far better state since even heavy accumulations of salt on a baked tablet are virtually harmless. A few of the tablets found the first season may have been baked accidentally in the conflagration which turned the walls of several rooms into reddish baked bricks, but the principal group of tablets found the second season had not been touched by fire.¹

The site of Tell Abū Ṣalābīkh has lain abandoned for approximately 4500 years, and the present surface of the mound has a heavy concentration of salt (enough that the mound looks snow-covered when it begins to dry out after a rain). Nearly all the tablets lay only a few inches below the surface, and the millennial seasonal fluctuations have caused the unbaked tablets to grow tall salt crystals, some as much as half an inch in length. The crystals form not only on the surface, but in cracks as well, so that often tablets are thrust apart in various directions (see Fig. 20 for an example). The problems involved in the excavation of these tablets can readily be imagined (see Figs. 21, 22, and 23, which show the excavations at various stages). The abnormal size of many tablets also complicated the problem, as did the fact that they appeared to be in a refuse heap, mixed in with chunks of bitumen, sherds, and a considerable quantity of fish bones. Rodents had also burrowed among the tablets, though, of course, not necessarily in ancient times.²

As an aid to holding large tablets together and to protecting the inscribed surface, the exposed areas of some were wrapped with gauze, held in place by a mixture of acetone and Duco Cement. All this was burned off during the firing. When our supply of glue was exhausted, we used paraffin in its place. While the paraffin was also burned off during the firing, the surface of the tablets treated in this way seemed to be more fragile than the others.

Miss Selma al-Radi's extensive experience in field conservation of the Nimrud ivories had given her skills and patience for the very tedious work on the tablets. Together we developed the techniques which enabled us to treat the tablets safely.

Experiments with baking uninscribed pieces and pieces of doubtful worth showed that a temperature high enough to burn out most of the salts also burned out the salts in the cracks in the tablets and that such tablets could not be picked up after firing without their falling apart in

1. In contrast, it appears likely that a considerable proportion of the tablets found at Fara were baked (see *Mitteilungen der Deutschen Orient-Gesellschaft*, No. 16 [November, 1902–April, 1903] pp. 9, 12), perhaps in the great fires which destroyed a number of the structures. This probably accounts for the relatively good preservation of most of the published Fara tablets, since they could not be penetrated by worms or

roots and since damage from salt accumulations is normally negligible in the case of baked tablets.

2. Through the courtesy of Dr. Henry T. Wright, the fish bones were examined by a specialist at the Smithsonian Institution in Washington, but it was not possible for him to identify the species. The rodent bones were identified as Bandicoot rat (*Nesokia Indica*) and the common house mouse (*Mus musculus*).

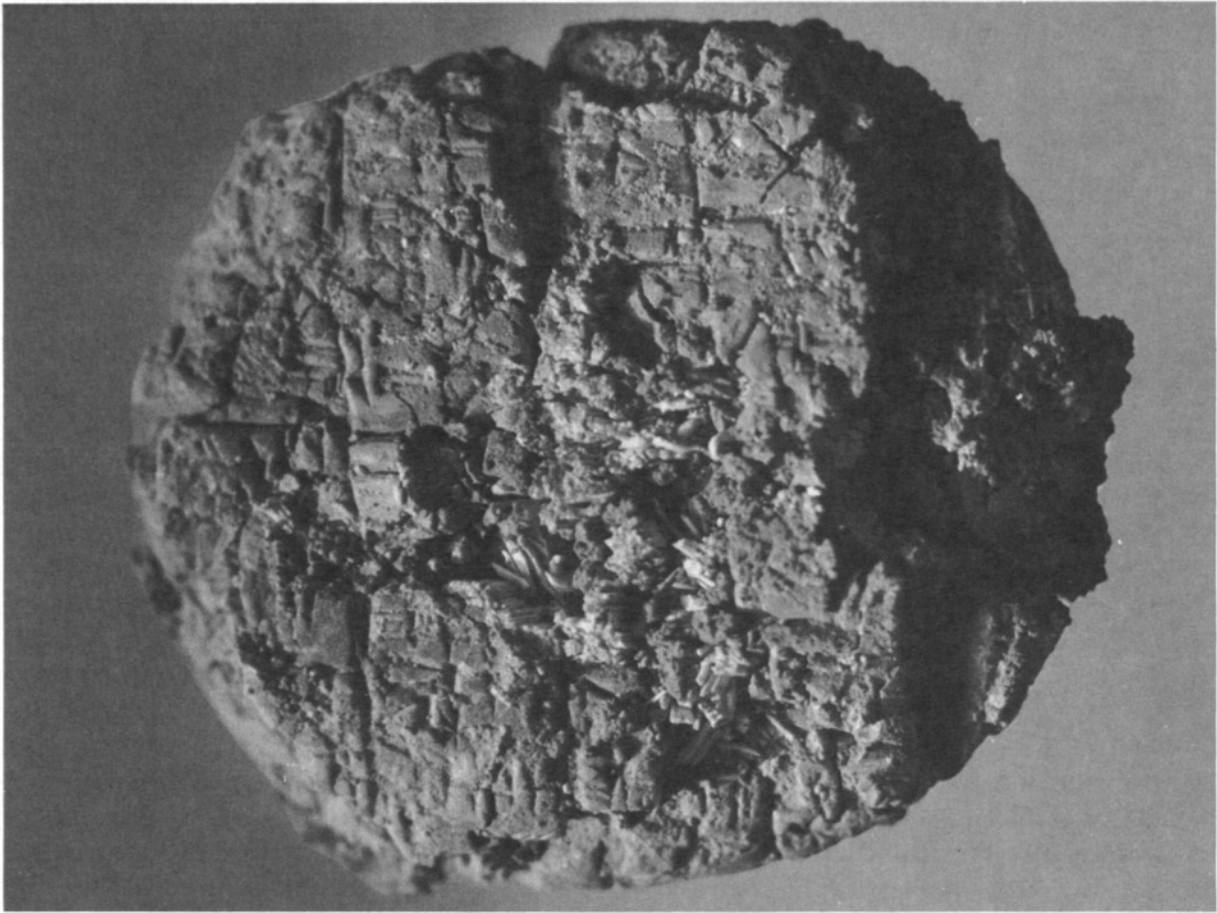

FIG. 20.—TEXT NO. 253 SHOWING DISTORTION CAUSED BY THE GROWTH OF SALT CRYSTALS



FIG. 21.—EXCAVATION OF HOARD OF TABLETS DISCOVERED IN ROOM 31



FIG. 22.—THE HOARD OF TABLETS NEAR THE END OF EXCAVATION



FIG. 23.—DETAIL SHOWING FIELD TREATMENT OF FRAGILE TABLET DURING EXCAVATION

numerous chips. A lower temperature left more of the salts in the cracks. Nevertheless, after they were baked, it proved impossible to pick up any but small pieces of surface layers without breakage. We adopted the method of removing the sand from over the tablets carefully, blowing the last of the sand away with a syringe, then, using a medicine dropper, putting glue in the cracks (starting with a very dilute solution with greater capacity to penetrate the tablet). Only when the tablet had been thoroughly glued on the exposed surface was it lifted out of the sand, and the glue applied to cracks in the other side as needed. Fortunately, I had decided during the excavation that tablets ought to be packed in the sand with the inscribed side up. This permitted a more thorough treatment of the inscribed side (many had no inscription on the reverse) after baking.

Except for copies of the Standard Professions List, for which tradition may well have dictated an approximately uniform size and shape, as had been used in earlier centuries, most of the Abū Ṣalābīkh literary and lexical texts (excluding exercise tablets) were written on large tablets. A standard size was approximately 21–23 cm. square (often a tablet lacks several millimeters of being exactly square). Others, particularly the UD.GAL.NUN category, were sometimes written on tablets considerably larger. None of these is completely preserved, but since the thickest part of the tablet in the center of the reverse is preserved in some cases, reliable estimates can be made. For example, when complete, No. 142 (AbS-T 363) was approximately 40 × 40 cm. Tablets are often 4–5 cm. thick. Others are as much as 7–8 cm. thick. In many instances the column widths are so constant, approximately 2.5 cm., that one wonders if this may correspond to a standard unit of length in the early Sumerian system.

A feature of these large tablets is that they are normally made with a core of clay which is smoothed in a somewhat irregular fashion, probably to make the surface layer adhere more securely (see photographs of Nos. 33, 47, 112, 151, etc.; see Fig. 24 for typical examples of the undersides of surface layers). The surface layer is fine clay, normally about 1.4 cm. thick. This surface layer separates very easily from the core and consequently a number of our fragments consist of the surface layer only.³ The few cases I have noted of an Abū Ṣalābīkh tablet made in one piece have a script so distinct that one may wonder whether they were even made or written at Tell Abū Ṣalābīkh. I have in mind particularly the tablets Nos. 255 (AbS-T 218) and 256 (AbS-T 393), and No. 326 (AbS-T 227).

After a study of the tablets, it became clear that the group of which the large pile in room 31 was the principal part was not restricted to that room. Tablets bearing related colophons were found about ten feet away in the adjoining room 21. The pile of tablets had also been damaged and scattered about in room 31 (after occupation of the room had ceased, since no tablets were found on a floor level). In one instance there is a virtually certain join between fragments found several yards apart.⁴

Although the principal group of tablets was probably written or stored in room 31 or a nearby room, it was not possible to determine which room it was. Among the tablets in the principal group were a number of pupils' writing exercise tablets (see Fig. 25 for a crumpled exercise in making wedges). This indicates that there was a scribal school in the immediate vicinity as well as the *scriptorium* of the skilled scribes.⁵

A small fragment of clay of the same quality as the surface layer for tablets, catalogued as AbS 378, was found with No. 470 (AbS-T 157). Since a mark on one side of it appears to have been made with a stylus, the piece may have been associated in some way with the process of preparing the clay from which tablets were made. The other side has the impression of a textile

3. I have noted this process of making tablets in only a few of the contemporary tablets from Fara which I have personally examined.

4. Nos. 259 and 265 (AbS-T 198 and 147). Since the fragments have suffered from expansion of salts and earth in

differing degrees, a complete physical join is not possible without laboratory work.

5. Some of the more poorly written exercise tablets are published together in this volume as Nos. 458–71; others are published elsewhere in the volume but are identified as exercise tablets in the descriptive Catalogue of Published Texts.

and a string (see Fig. 26A and B). It is a standard, rather uneven plain tabby weave with about twelve threads per centimeter in one direction and ten in the other.⁶ Perhaps the bit of clay once marked a scribe's supply of damp clay wrapped in cloth to preserve its moisture, but this is merely speculation.

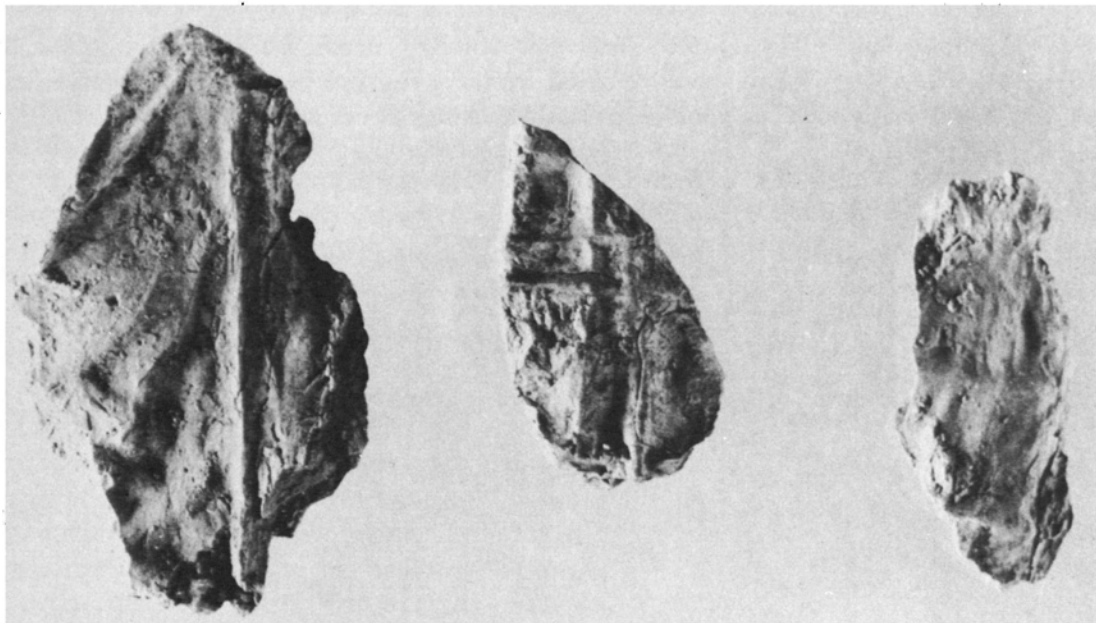

FIG. 24.—UNDERSIDE OF SURFACE LAYERS OF TABLET. SCALE, 4:5

In his description of the site of Tell Abū Ṣalābīkh and of the architecture associated with the tablets, Donald Hansen has mentioned that no proof of the ancient name of Tell Abū Ṣalābīkh has been found. So far even the evidence that votive texts would provide is lacking, and other contemporary sources have not given solid clues as yet.

Some years before excavation at Tell Abū Ṣalābīkh began, Thorkild Jacobsen proposed that the site might be Kesh, but Tell Jidr has more recently been identified tentatively with Kesh by A. Falkenstein, partly because of the site's proximity to Adab.⁷ The close relationship between Kesh and Adab has long been known and is emphasized even more by the texts published in this volume; in addition to texts published here, note the description of Adab in a "city riddle" from the time of Enannatum or Entemena (from a tablet excavated by the Metropolitan Museum-Institute of Fine Arts, New York University expedition to Al-Hiba): *íd-bi íd-kēš^{ki} / [dingir-b]i* ^dAš-šIR-gi₄ lugal-KI-AB, "(the name of) its canal is the Kesh Canal, (the name of) its god is Ašgi, the lord of . . ."⁸

One is nevertheless left with the fact that the town occupying the site of Tell Abū Ṣalābīkh must have been relatively important and well known, and thus its name should appear in the documentation from the site itself or elsewhere. I have already called attention to AbS-T 188 (No. 463

6. For the definition of "plain tabby weave," see Irene Emery, *The Primary Structures of Fabrics* (Washington, D.C., 1966) pp. 85-86. I am grateful to Mr. and Mrs. Harold Burnham of the Textile Department of the Royal Ontario Museum for this description. It was not possible, on the basis of the photograph, for them to make a positive identification of the fiber.

7. Cited by R. Adams, "Survey of Ancient Water Courses and Settlements in Central Iraq," *Sumer* XIV (1958) 103

(where Kish is a typographical error for Kesh); Thorkild Jacobsen, "The Waters of Ur," *Iraq* XXII (1960) 176. See A. Falkenstein, "Sumerische religiöse Texte," *ZA* LV (1963) 19, n. 45. The most recent discussion of the problem is by Hans Nissen in Robert McC. Adams and Hans J. Nissen, *The Uruk Countryside: The Natural Setting of Urban Societies* (Chicago, 1972) p. 52.

8. Robert D. Biggs, "Pre-Sargonic Riddles from Lagash," *JNES* XXXII (1973) 31, col. xi ll. 5'-6'.

INTRODUCTION

in this volume), which includes names of important cities: Adab, Nippur, Lagash, Shuruppak, and Umma.⁹ I suggested that Uruk be restored in the missing first line, but I now believe a restoration of Kesh is much more probable. Even if that is correct, it cannot be considered evidence that Abū Ṣalābīkh either was or was not Kesh. Without better evidence, detailed investigation of other possibilities, for example, Eresh, would not be appropriate here.

I believe that Abū Ṣalābīkh tablets were approximately contemporary with the so-called *Schultexte* from Fara. Even though none are dated, evidence suggests that they are closely related. The scribal repertory at both Fara and Abū Ṣalābīkh included many of the same texts, with the

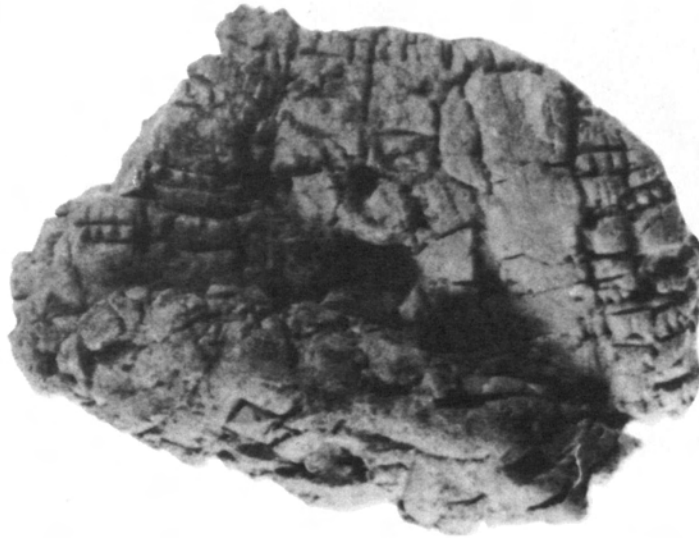

FIG. 25.—AN ELEMENTARY PUPIL'S CRUMPLED WRITING EXERCISE. APPROXIMATELY ACTUAL SIZE

tablets sometimes even having the same distribution of lines in the columns. The type of colophon in use on tablets from both sites is virtually identical (see ch. 3 for further discussion of the colophons), and they are often separated from the text by hatching (some examples in this volume are Nos. 23, 39, 42, 43, 46). Moreover, the repertory of signs in tablets from both sites is practically identical, although at each site there are a few signs not yet attested from the other. Ligatures, in which an element of one sign serves at the same time as part of a contiguous sign, occur at both Fara and Abū Ṣalābīkh, but they are more common at Abū Ṣalābīkh.¹⁰ At the same time, there are distinct differences. In handwriting, for example, there is variation in the direction of the perpendicular wedge in such signs as SAG and KA in Abū Ṣalābīkh texts.¹¹ A further distinction is that in Abū Ṣalābīkh texts the slanting wedges at the end of ZI have their "heads" on the horizontal wedge, but that in GI (as in ŠE) the heads are in the opposite direction and the "tails" touch the horizontal. The only distinction in Fara texts between ZI and GI is that ZI has fine

9. "The Abū Ṣalābīkh Tablets: A Preliminary Survey," *JCS* XX (1966) 77, n. 32.

10. ŠEŠ+KI is a standard ligature. A ligature which occurs several times in Abū Ṣalābīkh texts is ŠEŠ+IB, also common earlier; see *UET* II, Nos. 61:1, 65, and *passim*. See IAS 392 for an example where the wedges at the beginning of the ŠE sign serve also as the final wedges of MU. There are a

number of others, and since they are not to be considered errors, they are not marked with *sic* in the copies.

11. See *JCS* XX 76, n. 22. Since most of the "school texts" from Fara are published in transliteration, it was not possible to make an adequate check on such details in the Fara tablets.

horizontal wedges crossing the top wedges.¹² There is often variation between Fara and Abū Šalābīkh in writing rare signs. A more striking difference is that Fara tablets are often inscribed beginning on the upper edge, and sometimes the text begins on the left edge.

When Deimel proposed that the Fara tablets were to be dated not long before Ur-Nanše of Lagash, perhaps only a century or two, he was contradicted by E. Unger, who insisted that they were much later than Ur-Nanše, in fact from approximately the time of Urukagina (that is, 150 or 200 years later).¹³ In his reply, Deimel answered in detail the many erroneous statements by Unger and summarized again the principal arguments for an earlier dating: the occurrence of curved lines in LUGAL and a number of other signs, the three forms of the sign A, occurrence of signs closely resembling their pictographic ancestor (KAŠ and DUG, for example, still have a wedge representing the spout on a pot), and the occurrence of many previously unknown signs, not only in the "school texts" but in the administrative documents as well.¹⁴ Deimel's dating was not disputed again until Viktor Christian insisted that the form of the bricks, the pottery, seals, and the like excavated at Fara all contradicted Deimel's date. He, too, proposed a date about the time of Urukagina and disposed of paleographic arguments by saying that the tablets merely seem older because of local peculiarities in the writing.¹⁵ He in turn was answered by Deimel, who, exhibiting some impatience, described in detail the salient features of cuneiform writing in Ur III and all earlier periods from which cuneiform texts were then known.¹⁶ The basic correctness of Deimel's dating has not been disputed since. Nevertheless, there still remain chronological difficulties. The chronology of the Lagash dynasty of Ur-Nanše is not even assured, and only rough estimates can be made for the reigns of several of the rulers.¹⁷ Most of the documents known from the Lagash area are from the latter part of the dynasty, particularly Lugalanda and Urukagina.¹⁸

For the moment, our most reliable criterion for a relative dating must be the evidence from the tablets themselves. In the first place, the tablets from both Abū Šalābīkh and Fara generally have the signs arranged within the cases in an arbitrary fashion (note, for example, that in the Zà-mì Hymn collection several manuscripts write mì before zà), a practice which, at least in Lagash, was given up at about the time of the reign of Eannatum. The script itself is normally taken as the best evidence for dating. It is probable that no one will at this point dispute that the script is earlier than any of the inscriptions on clay from Lagash, but how much earlier is difficult to estimate, for features of the archaic script which appeared to be isolatable and chronologically significant when the body of material was much smaller now appear to be of considerably less value than has usually been assumed. For example, variants in the writing of such common signs as MÛŠ (INANNA) and DU, variants which once would have been sufficient to suggest a chronological difference, occur frequently on the Abū Šalābīkh tablets from the same locus and even on the same tablet. A few of the tablets are stratigraphically earlier than the bulk of the tablets (most of these are published in this volume in photograph so that whatever distinctive features they may have may be seen more readily), but because they are so few, one would hesitate to put too much stress on their characteristics. No. 3 appears to have rather elongated signs; it also has more horizontal wedges in such signs as GAL than do the majority of texts. Nevertheless, a

12. For discussion and other examples, see my article, "On Regional Cuneiform Handwritings in Third Millennium Mesopotamia," *Orientalia* n.s. XLII (1973) 39-46.

13. LAK, p. 4; E. Unger, "Das Alter der Keilschriften von Fara," *ZA* XXXIV (1922) 198-205.

14. Deimel, "Das Alter der Fara-Texte," *Orientalia* VI (1923) 51-57.

15. Christian, "Die zeitliche Stellung der Fara-Tafeln," *Mitteilungen der altorientalischen Gesellschaft* IV (1928) 9-12.

16. Deimel, "Die zeitliche Ansetzung der Fara-Texte," *Orientalia* XXXIV/XXXV (1928) 122-27. Note his remark

"Seine ständige Beschäftigung mit der Præhistorik wird seine wissenschaftliche Untersuchungsmethode verwildert haben," p. 123.

17. See M. Rowton, in *Cambridge Ancient History* I, Part 1 (3d ed.; Cambridge, 1970) 220-26.

18. For the sake of uniformity with earlier discussions, I have retained the traditional reading Urukagina, even though W. G. Lambert, in "The Reading of the Name uru.kā.gi.na," *Orientalia* n.s. XXXIX (1970) 419, has given evidence that the name should be read Uruinimgina.

number of the later texts (e.g., No. 388) also have signs with more than the usual number of wedges. Other stratigraphically early texts, for example, No. 4, if mixed in with the bulk of the tablets, would probably not be identified as earlier. In fact, several of the texts from the principal locus are written in a handwriting so distinct from others that one would be tempted to suggest a *chronological* difference as well. Close chronological arguments based on an analysis of sign forms have, in my opinion, relatively little value as long as our approach to paleography is not more sophisticated than it is at present.

Earlier I expressed the opinion that more reliable chronological indications could be inferred from the signs in the normal scribal repertory than from handwriting features.¹⁹ On this basis, and with reserve (since texts of a comparable nature are not available from Abū Ṣalābīkh and



FIG. 26.—IMPRESSION OF A TEXTILE AND STRING ON CLAY (A) AND ON THE OPPOSITE SIDE A MARK MADE WITH A STYLUS (B). SCALE, 3:2

Fara or from Lagash, and since there are no dated texts and no synchronisms whatever to connect the rulers of the Lagash dynasty with persons known in the tablets from Fara or Tell Abū Ṣalābīkh), I would suggest—and it is no more than a suggestion—that the Fara–Abū Ṣalābīkh texts probably antedate the reign of Ur-Nanše by one or two generations, that is, that they fall toward the beginning of Early Dynastic IIIA.²⁰ Therefore, if Ur-Nanše is dated to about 2550 B.C., the Fara and Abū Ṣalābīkh tablets are probably to be dated somewhere around 2600 B.C.

An interesting fact in this period is that there appears to have been considerable communication among the cities of Sumer, not only of a commercial nature but scholarly as well. It would appear that texts were circulated even earlier, to judge from the spread of the Standard Professions List,²¹

19. *JCS* XX 76.

20. See E. Porada, in R. Ehrich, *Chronologies in Old World Archaeology* (Chicago, 1965) pp. 161–65, for the dating criteria of ED II and III. Miss Porada proposes that ED IIIB began in the reign of Eannatum of Lagash. William W. Hallo's article

"The Date of the Fara Period: A Case Study in the Historiography of Early Mesopotamia," in *Orientalia* n.s. XLII (1973) 228–38, appeared after composition of this volume had begun. It has not been possible to take it into consideration.

21. *MSL* XII (Rome, 1969) 4–12.

a sign list attested at Fara and Jamdat Nasr, and duplicates of a list of professions from Tell Abū Ṣalābīkh found also at Gasur,²² and Kish,²³ to mention only duplicates of Fara and Abū Ṣalābīkh texts found beyond central Sumer. Most major cities may well have had scribal centers, but with the small amount of evidence from sites other than Fara and Tell Abū Ṣalābīkh, it is difficult to define different scribal traditions.

An important problem involving the period of the Fara–Abū Ṣalābīkh tablets is the possible role of a Semitic element in the population. Until the discovery of the Abū Ṣalābīkh tablets, the evidence for Semites at that time was limited to a few words thought to be Semitic loanwords in Sumerian and to a few clearly Semitic names.²⁴ I expanded somewhat the list of probable Semitic names from Fara previously suggested by Gelb, and I would now consider some of the names I listed as possibly Semitic to be more certainly Semitic.²⁵

The striking new element introduced by the Abū Ṣalābīkh tablets is that not only do Semitic names appear in the administrative texts, but approximately half the names in the colophons to the lexical and literary texts are Semitic.²⁶ As I stressed before, however, this is no evidence that the particular individuals whose names appear in the colophons were of Semitic stock.²⁷ Nevertheless, whether these scribes were Semitic or of mixed Sumerian-Semitic background or whether the area included a group of people with Semitic names who were so prestigious that their name types were in common use among another linguistic group cannot be said. I incline toward the view that Semitic people had been living in the area for some time, in peaceful urban society. It seems entirely probable that some of the scribes were indeed of Semitic background.

22. *Ibid.*, pp. 16–21.

23. *MAD* No. 5, p. 31, No. 35 and Pl. XIII. I owe the identification of this tablet to Dr. Claus Wilcke.

24. See for example, D. O. Edzard, "Sumerer und Semiten in der frühen Geschichte Mesopotamiens," *Genava* n.s. VIII (1960) 241–58.

25. "Semitic Names in the Fara Period," *Orientalia* n.s. XXXVI 57–58, especially n. 5; *MAD* No. 2 (2d ed.) p. 4.

26. Biggs, in *Orientalia* n.s. XXXVI 55–66. By "approximately forty non-Semitic names," p. 60, n. 3, I meant obviously Sumerian names and others which I could not identify with certainty as being Sumerian.

27. In *Orientalia* n.s. XXXVI 57, n. 2; see also F. R. Kraus, *Sumerer und Akkader: ein Problem der altesopotamischen Geschichte* (Amsterdam, 1970) pp. 17–18.

III

THE LITERARY AND LEXICAL TEXTS FROM FARA
AND TELL ABŪ ṢALĀBĪKH

THE tablets from Tell Abū Ṣalābīkh are the only significant group of cuneiform texts of the mid-third millennium B.C. to be discovered in Mesopotamia since the finds of the Deutsche Orient-Gesellschaft at Fara (ancient Shuruppak) in 1902 and 1903.¹ Since our approach to the Abū Ṣalābīkh tablets and subsequent study of them will necessarily be heavily influenced by what has been learned from the tablets from Fara in the past half-century, it is necessary to look briefly at the Fara tablets for a certain amount of comparative material.

THE FARA TABLETS

The publication of the Fara tablets was carried out by A. Deimel and R. Jestin.² Although in 1931 Erich Schmidt excavated at Fara on behalf of the University Museum, Philadelphia, comparatively few tablets were found. A preliminary report on them, in which some key words were given for each text, was published by S. N. Kramer.³

Despite the statements of Deimel and Jestin that all Fara tablets in the Berlin and Istanbul museums, respectively, were published, hundreds of fragments still remain unpublished, although many of these are relatively insignificant fragments of administrative texts.

The usual view among cuneiformists was that until late in the third millennium B.C. the use of the cuneiform script was limited mainly to the production of administrative texts, contracts, and other documents necessary to keep accurate records and that the word lists (the so-called *Schultexte*) were for the purpose of familiarizing scribes with the signs and words they needed for that purpose.⁴ It was therefore hardly surprising that some of my senior colleagues in Europe and America were politely skeptical when I told them in 1963 that we had found Sumerian literary texts of the Fara period at Tell Abū Ṣalābīkh. Press reports resulting from an interview with expedition members at Tell Abū Ṣalābīkh, in which I had put great stress on the quantity and importance of the literary texts, appeared in February, 1965, but it was not until several months later when I returned to Chicago and identified the Instructions of Shuruppak among the tablets that skeptics were convinced that the texts were indeed something other than word lists alone.

An important point, which could hardly have been made as long as the Fara tablets remained an isolated phenomenon, is that the Fara and Abū Ṣalābīkh tablets seem to represent the first great flowering of Sumerian literature and the culmination of the archaic Sumerian tradition of scholarship. That so many persons should be occupied with such esoteric work which has no

1. Described in field reports in *Mitteilungen der Deutschen Orient-Gesellschaft*, No. 15 (November, 1902) pp. 8-14, No. 16 (November, 1902-April, 1903) pp. 9-15, and No. 17 (August, 1903) pp. 4-14.

2. *Fara II*, *Fara III*, *TSS*, and *NTSS*.

3. "New Tablets from Fara," *Journal of the American Oriental Society* LII (1932) 110-32.

4. See, for example, A. Falkenstein, in A. Falkenstein and W. von Soden, *Sumerische und akkadische Hymnen und Gebete* (Zurich, 1953) pp. 11-12.

obvious economic benefit surely implies an interest in literature and learning on the part of the rulers and could only have happened during a period of relative calm and prosperity.

Most of the tablets are of the type designated "Schultexte" by Deimel,⁵ a term which may have given cuneiformists who had not studied them closely the impression that they were school exercise tablets, since the term "school text" has been used by Landsberger and other scholars to designate pupils' writing exercises.⁶ The term "Schultexte" is unfortunate for modern scholars since it seems to have isolated the scholarly traditions of the Fara period from the later tradition in an artificial way. Of course, at the time Deimel published the texts, there were no recognized direct links to the later Sumerian traditions. In fact, the "school texts" from Fara and Abū Ṣalābīkh are only school texts in the sense in which nearly all traditional, scholarly writings preserved for us are.⁷

The number of Sumerian literary texts before the Fara period is small indeed. One from Uruk was published by J. van Dijk, and I have called attention to one from Ur. Other earlier texts, if they exist, have not been identified.⁸

In 1951 A. Falkenstein called attention to a Fara tablet (SF 71) as an É-nu-ru incantation, apparently the first published note that the "school texts" contained anything besides lists of words,⁹ although Deimel came close to realizing it; indeed, he was troubled by some of the texts because he could not identify the nature of the "list."¹⁰ These are among the texts now known to be literary. M. Lambert, who has made many valuable and perceptive contributions toward the interpretation of pre-Sargonic texts, pointed out the literary character of SF 40 and gave a number of lines in tentative transliteration and translation.¹¹ More surprising were the identification by T. Jacobsen of a saying or proverb in a Fara tablet and the subsequent identification by W. G. Lambert of another saying in the same composition.¹² In 1964 J. van Dijk transliterated the introductory lines of a literary text from Fara, TSS 79, and mentioned that some of the Fara texts appear to be mythological but did not identify them specifically.¹³

The published Fara texts are accessible to scholars in a somewhat mixed degree. Since most of those published by Deimel are published in transliteration, there is now at least a potential for confusion since the values he uses for signs are often not the ones currently in use.¹⁴

Several years ago I pointed out peculiarities Deimel introduced in his cuneiform copies that tended to make signs appear more archaic than they are.¹⁵ Nevertheless, I do not wish to imply that Deimel's publication is careless, for his transliterations are on the whole remarkably accurate and were obviously rechecked with care. I have considerable respect for the quality of his work. In general, Jestin has represented the *ductus* of the scribes more faithfully, but in other ways his work is less careful than that of Deimel.

5. "Schultexte, d.h. Wort- und Zeichenlisten, welche dem Schulgebrauche dienen," *Fara II 1**. Falkenstein, *Archaische Texte aus Uruk* (Leipzig, 1936) p. 46, preferred to call them lists.

6. There were in fact school exercise tablets which were recognized by Deimel and which he indicated as such.

7. They were described by S. N. Kramer, *From the Tablets of Sumer* (Indian Hills, Colo., 1956) p. 3, as "textbooks" and collectively referred to in *The Sumerians* (Chicago, 1963) p. 26, as lexical texts, important for showing the existence of Sumerian schools. See also the description by Jestin, in his preface to *NTSS*, p. 7: "exercices faits par des élèves-scribes ou préparés par eux."

8. J. van Dijk, "Inscriptfliche Funde," in H. Lenzen, *Vorläufiger Bericht über die . . . Ausgrabungen in Uruk-Warka XVI* ("Abhandlungen der Deutschen Orient-Gesellschaft," No. 5 [Berlin, 1960]) 58-59; in *JCS* XX (1966) 78, n. 38, I suggested that *UET II*, No. 69 is probably a literary text, an identification tentatively accepted by Sjöberg in *TCS III* 7.

9. "Zur Chronologie der sumerischen Literatur," *Compte rendu de la Seconde Rencontre Assyriologique Internationale* (Paris, 1951) p. 19.

10. See *Fara II 24** for his comment on SF 36 and 37.

11. "Épigraphie présargonique (VI)," *RA* XLVII (1953) 143-44.

12. In E. I. Gordon, *Sumerian Proverbs* (Philadelphia, 1959) p. 550; Lambert, "Celibacy in the World's Oldest Proverbs," *Bulletin of the American Schools of Oriental Research*, No. 169 (1963) pp. 63-64.

13. "Le motif cosmique dans la pensée sumérienne," *Acta Orientalia* XXVIII (1964) 34-35.

14. Some values are listed in *Fara II* 76 with the signs for which they are used, but in other instances one can only be sure what sign is used by recourse to the sign list in his *Pantheon Babylonicum* (Rome, 1914) or to photographs; for example, his *cin* is our *cin*.

15. See *JCS* XX 75, n. 20.

THE ABŪ ṢALĀBĪKH LITERARY AND LEXICAL TEXTS

The literary and lexical texts form the largest single group of texts from Tell Abū Ṣalābīkh and include known compositions, principally the Kesh Temple Hymn and the Instructions of Shuruppak¹⁶ among the strictly literary material, besides duplicates of other texts, principally lexical, already known from Fara. These are mentioned in more detail in the descriptive Catalogue of Published Texts.

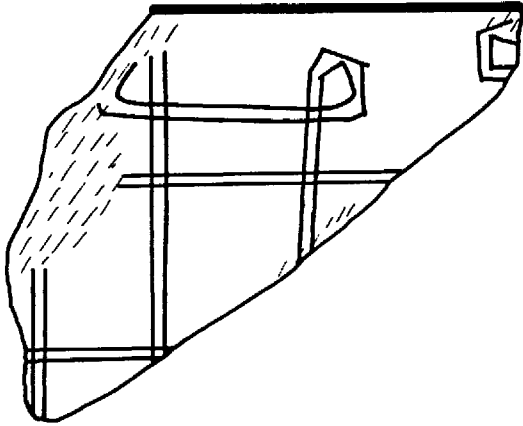
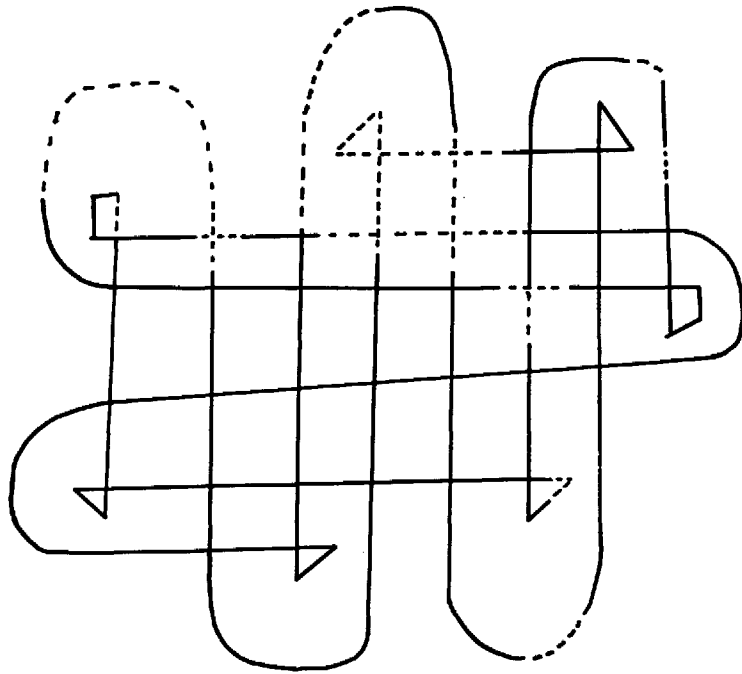

FIG. 27.—DESIGN COPIED FROM A FRAGMENTARY TABLET. ACTUAL SIZE

FIG. 28.—DESIGN FROM NO. 47 (ABS-T 222), BASED ON A DRAWING BY HARRIET OSBORN, WITH RESTORATIONS IN DOTTED LINES. ACTUAL SIZE



As in Fara texts, it is only in exceptional cases that the literary or lexical tablets are inscribed fully on both obverse and reverse; exceptions are Nos. 112 and 256, the Instructions of Shuruppak. In the case of No. 112, the identification of obverse and reverse is not completely certain, and one cannot know from external indications what sequence the columns on the reverse have. In some instances, the colophon is in the last column on the right of the reverse, and hence the left-to-right sequence of columns is obvious. In other instances, for example No. 275, comparison

16. Biggs, "An Archaic Sumerian Version of the Kesh Temple Hymn from Tell Abū Ṣalābīkh," *ZA* LXI (1971) 193-207; Biggs, *JCS* XX 78; M. Civil and R. D. Biggs,

"Notes sur des textes sumériens archaïques," *RA* LX (1966) 1-5. A partial edition of the Instructions of Shuruppak is given below, pp. 57-62.

with duplicate texts has confirmed a left-to-right sequence. In all instances lacking clear evidence, I have arbitrarily assumed that the column sequence on the reverse of tablets is right to left.

Several of the tablets have designs on the reverse similar to those on the Fara tablets (with the exception that drawings of humans and animals do not appear on the Abū Ṣalābīkh tablets).¹⁷ One such design has already been published in photograph. Several others are on tablets published in photograph in this volume (Nos. 47, 60, 282). Some are reproduced in line drawings in Figs. 27 and 28 and in photograph in Fig. 29.

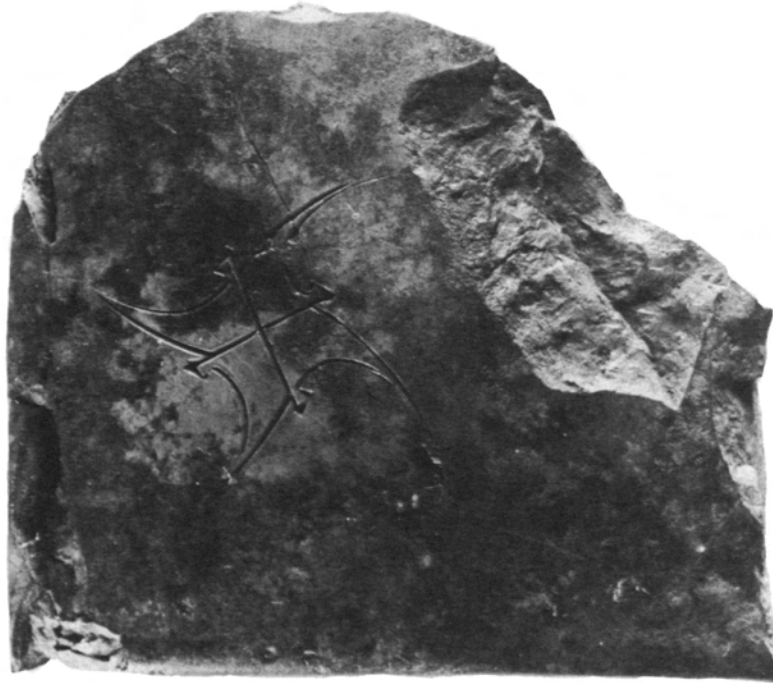

FIG. 29.—REVERSE OF NO. 2, SHOWING DELICATE DESIGN AND SKILLFUL EXECUTION. SCALE, 2:3

THE LITERARY TEXTS

The new tablets allow us, for the first time, to see that some of the traditional works of Sumerian literature go back as much as eight centuries before our previously known copies; the most notable example so far identified is the Kesh Temple Hymn. The even more surprising fact that the text in the Kesh Temple Hymn is virtually unchanged except in orthography over these centuries suggests that other traditional works of literature may also go back in essentially their present form to the last third of the third millennium B.C. at least.

The literary texts, which make up the largest part of the entire tablet collection, fall rather easily into two distinct groups. One group, which includes the Kesh Temple Hymn, the Instructions of Shuruppak, and the proverb collection, is made up of texts written in an orthography more or less similar to that used in Old Babylonian Sumerian literary texts. In this group most of the signs are known and are fairly unambiguous, and a number of lines can be read and understood with a fair degree of certainty. A major text in this group, the Zà-mì Hymn collection,¹⁸ is published in this volume in a critical edition based on a number of Abū Ṣalābīkh

17. For the Fara designs, see E. Heinrich, *Fara: Ergebnisse der Ausgrabungen der Deutschen Orient-Gesellschaft in Fara und Abu Hatab, 1902/03* (Berlin, 1931) Pls. 27-33; *JCS* XX 83, Fig. 3.

18. Zà-mì, "praise" in Sumerian.

manuscripts. Another important composition in this group is the collection of proverbs or sayings. With the identification of additional published texts from Fara,¹⁹ and because of the numerous variants, this text will be an important source for insights into the archaic Sumerian writing. Most other texts in this group exist in only one or two fragmentary copies. More complete information on them will be found in the catalogue, Nos. 255 to 397. Noteworthy is No. 326, in which ù, “and,” occurs; even at this early date Sumerian may have been under a heavy Semitic influence.

The second major group of texts, which I have designated UD.GAL.NUN (meaning unknown), after a line which occurs very frequently, apparently reflects a different orthographic tradition in which even a different repertory of signs is in use. Several years ago I observed that the common Sumerian sign NAM did not occur in any texts identified as belonging to that category and that an unrelated sign NÁM (which several centuries later coalesced with the sign TÚG, “garment”) was used instead.²⁰ More recently I noted that the sign NA is apparently replaced in this genre by a sign resembling šA (which is known to have a value na₅), whereas the normal NA occurs only twice in many hundreds of lines.²¹ Among notable variants is UD for DINGIR in a passage cited below and frequently in these texts. No explanation is obvious. Equally interesting are occurrences of the sign LAK 171 (reading unknown) with variant DĪ (see No. 116 col. xii and duplicate No. 117).

Some of the most common signs in this group of texts (hundreds of occurrences) are extremely rare or not used in the first group of texts. At best a few scattered lines in the UD.GAL.NUN group can be interpreted plausibly. Most notable probably are the final lines of a text: u₄ èš-gal-nun / al-dù, “when(?) the great, superb temple was built” (No. 142 xxi 11–12); these lines are perhaps an indication that the texts have to do with temple rituals. Note also the reference to the donning of a linen garment in No. 133 col. iii, although of course there is no specific indication that this refers to a ritual act. In fact, since the text has guruš, “young man,” and not gala, “lamentation singer,” maš-maš, “exorcist,” or any other cultic person, the possible cultic relevance of the genre is in doubt. Note also DINGIR(variant: UD)-gal-nun EN.LÍL.KI / bára-UD an-ma-tuš / dam ^dNin-KID / dù mu-na-tuš, “the great noble god(?) of Nippur took a seat(?) on the pure²² dais, the wife, Ninlil, took a seat(?) in the cella(?)” (translation uncertain; No. 129 col. ix and duplicate, No. 142 col. xix), and also kaš-nun na₅-dè / din-nun na₅-dé, “he(?) libated superb beer, he(?) libated superb wine” (No. 167 v 2–3). In the text are mentioned a large number of deities, as well as the Tigris and Euphrates, various cities (e.g., Nippur and Kesh), craftsmen, birds, and animals (e.g., alim, lulim,²³ šeg₉, dàra-maš).

At the present time I am unable to account for the obvious peculiarities of writing in this group. I can find no specific evidence that a special dialect of Sumerian is involved, though this cannot be ruled out. For me, at the present time, the texts as a whole are virtually unintelligible, but I have confidence that they can and will be understood eventually, at least in part.

THE LEXICAL TEXTS

The lexical texts (a term intended to cover sign lists and word lists) include several well-known texts, principally a number of copies of what I have called the Standard Professions List, a text which had been in the Mesopotamian scholarly corpus since the time of Level IV at Uruk, that

19. See the descriptions of SF 26, 27, and 65 for joins with other fragments. The Abū Šalābīkh variants di for dib and za-za for záḫ-záḫ in the Fara version (mentioned in *JCS* XX 80, n. 46) are a vivid illustration of the hurdles in the archaic Sumerian writing system which challenge all our ingenuity.

20. *JCS* XX 81 and n. 57; there is now one possible occurrence, in IAS 243.

21. The occurrences are in Nos. 129 and 162. See *ZA* LXI 195.

22. See *CAD*, s.v. *ellu* (adj.), lexical section, for various Sumerian readings for UD in the meaning “pure.”

23. Note that lulim is written with the lu either separate or in the “head” of the sign; see No. 113 iv 4 and No. 115 iii 14.

is, several centuries before the date of our tablets.²⁴ Some of the signs used in this text are otherwise unknown in the Fara period.²⁵

Among the previously known compositions are copies of another text, Nos. 4, 7–9, known in the Jamdat Nasr period and among the Fara tablets.²⁶ Among the duplicates of Fara texts (all of which are specifically indicated in the descriptive catalogue) is one, No. 34, which is probably to be considered a Practical Vocabulary, covering vocabulary for kinds of stones, metals, garments, musical instruments, weapons, and the like. Lists of professions which appear to be in the tradition of *Lú = ša* have already been published.²⁷ Another composition, consisting of personal names and names of occupations, is unrelated to the list of professions. A critical edition, based on numerous fragmentary sources, is published below (pp. 62–71). Other lists, such as lists of animals (Nos. 25–28) and lists of wooden objects (Nos. 18–20) appear to be, in part at least, precursors of *ḪAR-ra = ḫubullu*. A large number of others do not fall into any easily recognizable category.

It should be noted that while in most genres of lexical texts, the Abū Ṣalābīkh and Fara versions are usually almost identical, this is not the case with the lists of gods. Many groups of the deities occur in lists from both sites, but there are substantial differences as well.

The word lists normally begin with a rounded mark (corresponding to *DIŠ* in later texts), sometimes very superficial, but occasionally consisting of a hole more than a centimeter deep (No. 34). This same device is used in some of the literary texts. Occasionally, as in No. 308, there are lines both with and without the mark. It is doubtful that any particular significance should be attributed to the occurrence or non-occurrence of this mark in the literary texts.

THE COLOPHONS

Deimel devoted a number of pages to a discussion of the colophons in the Fara tablets and to listing the names given in the colophons.²⁸ He had no difficulty in distinguishing the colophon from the text itself, for in many instances a small division line with cross-hatching ends the text proper. The names in the colophons are in any case not preceded by a line marker, so that even when the names are not preceded by the sign *SANGA*, “scribe,”²⁹ there can be no doubt. Because of the many names in some colophons, Deimel rejected the possibility that they were names of the owners of the tablets. He suggested instead that the names were those of the composers of the text or the persons who compiled the material for the text.

Many of the literary and lexical tablets from Tell Abū Ṣalābīkh have similar colophons. In fact, it appears probable that all literary and lexical texts (with the exception of exercise tablets) bore colophons. There is no single tablet in these categories from Tell Abū Ṣalābīkh where it is possible to show that there was no colophon. The situation was probably the same among the Fara tablets.

24. See *JCS* XX 82. It has been published in transliteration in *MSL* XII (Rome, 1969) 4–12, with commentary by H. J. Nissen for the early Uruk tradition and R. D. Biggs for the Early Dynastic version.

25. See *MSL* XII 4.

26. For the Jamdat Nasr tablet, see S. Langdon, “New Texts from Jemdet Nasr,” *Journal of the Royal Asiatic Society*, 1931, pp. 842–43; the Fara duplicate is SF 64.

27. In *MSL* XII 16–21, as Early Dynastic List E.

28. *Fara* II 2*–7*.

29. Deimel assumed that the sign *SANGA* should be read *sanga* and understood as the *sanga*-priest. Now it is generally recognized that the *sanga* was principally a temple administrator, though in some cases he may have had cultic duties; see J. Renger, “Untersuchungen zum Priestertum der altbabylonischen Zeit, 2. Teil,” *ZA* LIX (1969) 104–21.

We cannot be sure that the situation was the same in Shuruppak, but the earliest clear evidence of *sanga* as a temple functionary shows each deity or temple with only a single *sanga*; see Deimel, *Sumerisches Lexikon* II (Rome, 1930) No. 314:28. For this reason, we cannot consider that the persons whose names are preceded by the sign *SANGA* in these colophons are *sanga*-priests. Moreover, it is possible that some of the persons designated as *SANGA* in the colophons also appear in administrative documents as *dub-sar*, “scribe”; for the latter, see M. Lambert, “La période présargonique: La vie économique à Shuruppak,” *Sumer* IX (1953) 211–13. The names are *Inim-zi*, TSS 80; *Lum-ma* and *Lugal-kituš-[dùg]*, NTSS 294. Admittedly, these are all common pre-Sargonic names, and there is no evidence that the same individuals are involved. Furthermore, there is as yet no published evidence to prove that the *SANGA*'s and the *dub-sar*'s belonged to the same administrative organization.

Many colophons, like those in the Fara tablets, have a line *dub mu-sar*, “copied the tablet,” which, as Deimel observed, referred to the immediately preceding name.³⁰ There is no internal evidence to suggest a meaning for *dub šu-gál* (once written *dub šu mu-na-gál* at Fara, SF 55), but one would expect it to mean “owns the tablet.” *TIL-dub* (always written in this sequence) occurs in *Abū Šalābīkh* colophons but not in any from Fara. It perhaps has to do with “finishing” the tablet in some way.

The *Abū Šalābīkh* colophons have from one (No. 255) to more than twelve names (No. 298). Quite often the same names, *A-geštin-abzu*, *Um-mi-a*, and *Lugal-kisal-si*, occur in the same sequence.

It is now doubtful that the colophons list the names of the putative authors or compilers of the tablets. The names from the *Abū Šalābīkh* colophons are not duplicated in Fara colophons, and even duplicates of the same text from *Abū Šalābīkh* may have different names in the colophons. Since some names occurring in the colophons also occur in administrative documents from the same building, it is highly probable that they are all contemporary. The impression, then, is of a considerable number of persons (presumably all men, since there is no specific evidence that any were women) actively engaged in scholarly scribal activity.

The names of the scribes, insofar as I have been able to read them, are listed here in alphabetical order, with references to the texts in which they occur. A few names in which only a common element such as *Ur-* or *-il* is legible have been omitted.³¹

- | | |
|---|--|
| A-a-um-ku-li, No. 18 | É-[x]- ^d šE[š. KI], No. 124 (SANGA) |
| A- <i>DU-DU</i> , No. 479 | [E]n-[n]a(?) <i>-DUMU-il</i> , ³³ No. 487 |
| A-geštin-abzu, Nos. 34, 39 (restored), 46, 59, 91, 117, 128, 131 (restored), 142, 268, 476, 480 | En-na-il, Nos. 113, 117, 124 ([E]n-[n]a-il, [SANGA]), 128 (dub mu-sar), 268, 388(?), 473(?), 479(?) |
| A- <i>ḥa-ar-š(i)</i> , No. 18 (dub mu-sar) | En-na-na, Nos. 124 ([SANGA]), 163 (En-[na-na]) |
| A-kalam-du ₁₀ , No. 266 | Gal-zu, No. 82 |
| A-ki-[gal(?)], No. 20 | [Gá]l-ud, No. 487 |
| A-lum-dūr(BAD), Nos. 113, 163(?), 254 | Gu-ni-sum, No. 126 |
| A-lum-i-lum, No. 475 | ḪI(?) <i>-la-i-lum</i> , No. 298 |
| A-ul ₄ (<i>ḡR-gunú</i>)-gal, No. 298 | Ḫu-ti-um, Nos. 39, 91, 126(?), 268, 283(?), 472(?) |
| A-ur-sag, Nos. 20, 116 | ḪUR-tu, No. 116 |
| A-zu-zu, Nos. 117 (A-[zu-zu], [SANGA]), 132 ([A-zu]-zu), 283 | ḪUR-tu- ^d Nisaba, No. 34 |
| A-zu-zu-tur, No. 113 | I-bi-um, No. 116 |
| A-x-[pa]-d[ūr], ³² No. 25 | I-gi/gi ₄ -i-lum, Nos. 18, 20, 59(?), 124(?) ([SANGA]), 126, 163 (dub [mu-sar]), 254, 283, 483, 485 |
| A-x-geštin-abzu, No. 254 | I-ku-a- <i>ḥa</i> , No. 283 |
| A-x-x, No. 60 | I-ku-gu-il, Nos. 113, 268, 479 |
| A-[x]-x-si, No. 60 | I-ku-il, Nos. 61, 481 |
| Amar-abzu, Nos. 34, 474 | I-šī-x-gu-ni-x, No. 116 |
| BE-iš-ga, Nos. 122, 298 | I-ti-é, No. 122 |
| bíl-i[l], No. 479 | I-ti- ^d Ša- ^g gan, No. 34 (dub šu-gál), 268 (TIL-dub) |
| É-ḪI-nun, No. 43 | I-ti- ^d fd, Nos. 94, 163(?), 489 |
| É-kur-sikil, Nos. 122, 298 | I-ti-[(x)]-ud-an-GAM + GAM, ³⁴ No. 33 |
| É-[x]-i[l], No. 141 | I-[x]-ERfM, No. 141 |

30. Deimel, *Fara II* 3*. A number of different hands can be detected in the *Abū Šalābīkh* tablets, even in what one may consider the normal handwriting, but it appears certain that the tablets on which a certain individual's name is followed by “dub mu-sar” were indeed written by the same person.

31. The Semitic names were given in my “Semitic Names in the Fara Period,” *Orientalia* n.s. XXXVI (1967) 55–66. Errors in reading several of the names have been corrected here.

32. The sign transliterated x closely resembles LAK 350, except that it is turned clockwise 90° compared with the sign in Fara texts. The Fara form of the sign occurs in the Names and Professions List (see No. 69 rev.). The restoration was suggested by a name occurring in No. 511.

33. This name was read erroneously as [N]a-DUMU-il in *Orientalia* n.s. XXXVI 66.

34. This name was read I-ti-na(?)*-an-GAM + GAM* in *ibid.*, p. 65.

- I-x-ud-x, No. 146
 Ī-lum-gār, No. 254
 Ī-lum-ma-lik, No. 298
 Ib-^aMud, Nos. 124 (SANGA), 254, 485
 Il-dūr(BĀD), No. 142; No. 141 with gloss: Il-^{ur}dūr(BĀD)³⁵
 Il-su-a-ḥa, Nos. 131(?) ([Il-su-a]-ḥa), 132 wr. Il-sù-a-ḥa (SANGA), 298
 Il-sù-ERIM+x, Nos. 33, 39 ([dub mu]-sar), 47(?), 59 (d[ub m]u-[sar]) (?), 113, 132 (SANGA), 234 (dub mu-sar), 269 (dub mu-sar), 488 (dub mu-[sar])
 Il-sù-gār, Nos. 47, 113, 122, 175 (Il-sù-[x], dub [mu-sar]), 298, 476 (dub mu-sar)
 Il-^rzu¹-zu, No. 42 (dub šu-gál)
 Il-LAK 647,³⁶ Nos. 116, 283
 Im-lik-é, Nos. 20 (I[m]-[lik]-^ré¹), 126 (dub šu-gál), 266(?)
 Iš-dup-il, Nos. 116, 477, 482, 489(?)
 Iš-dup-^aKA.DI, Nos. 116, 477, 480
 Iš-dup-[il/^aKA.DI], Nos. 61, 131, 478(?)
 Iš-lul-il, No. 116
 I[š]-x-i-lum, No. 479
 Kaskal-ud, No. 91 (dub mu-sar)
 Ku-li, Nos. 13 ([U]r-engur-x-ku-li), 113, 266, 474, 478 (twice), 481, 484
 Lú [x]-x, No. 43
 Lugal-kisal-si, Nos. 34, 39, 46, 59, 117, 122, 128, 131, 142, 163, 175, 265, 268, 269, 298, 473(?), 476, 480, 486
 Mar-ù-ne, No. 34
 Me-šĀR x DIŠ-[x], No. 481
 Mes-ki-gal-la, No. 298
 Mes-lam-il, Nos. 116, 117 (dub mu-sar), 132 ([SANGA]), 477(?), 479(?) (TIL-dub)
 Mi-mud, No. 142
^aNisaba-an-dùl, No. 255 (dub mu-sar, reading uncertain)
 Nu-x-[x], No. 472
 Puzur-é,³⁷ No. 487 (TIL-dub)
 Puzur-il,³⁸ Nos. 13, 142 (dub šu-gal), 268
 Si-dù, No. 283
 Su-ma-a-ba₄, No. 34 (dub mu-sar)
 Su-ma-a-ḥa, Nos. 91, 142, 268, 269, 472 (dub mu-sar)
 Su_x(BU)-ma-a-ḥa, No. 142
 Šeš-[x-(x)], Nos. 39, 116, 487(?)
^rU¹-Aš-dar, No. 298
 Ū-ne-ne, Nos. 254 (dub [mu]-sar), 480, 484
 Ū-[x-x], No. 342
 Ud-silim, Nos. 82 (probably [Ud]-silim), 122
 Um-mi-a, Nos. 34, 39, 59, 117, 131, 142, 175, 268, 476
 [U]r-ab-ra, No. 478
 Ur-abzu, Nos. 94, 124 (Ur-a[bzu], [SANGA]), 472
 Ur-an-si, No. 42 (dub mu-sar)
 Ur-Dumu-zi-da, Nos. 122, 298
 Ur-^aEn-lil, Nos. 475, 479
 Ur-^aĪd, Nos. 47(?), 117, 265, 267, 268 (wr. Ur-^aĪd-da); see also Ku-li
 Ur-^a[La]mma, Nos. 14, 39 (Ur ^aLa[mma])
 Ur-^aNisaba, Nos. 20, 23 (TIL-dub), 82, 141, 254, 420, 487 (same name twice)
 [Ur(?)-sa]g(?)-dùn, Nos. 131, 163 (U[r(?)-sa]g-dùn(!))
 Ur-sag-me-x-x, No. 283
 Ur-sag-^aḤa-rí, Nos. 266, 474
 Ur-^a[x], Nos. 61(?), 116(?), 181
 Ur-ur, No. 268
 URU x A, No. 113
 URU x A-x-x, No. 142 (dub mu-sar)
 URU x [x], No. 25
 Uš-bi-a-ḥa, No. 283
 Uš-mi-il, Nos. 23 (dub mu-sar), 34
^aUtu-uš-x-Lamma, No. 61
 x-bi-a-ḥa, No. 142
 x-du₁₀, No. 479
 x-^{1a}E[n]-[lil], No. 267(?)
 x-k[a](?)-il, No. 483 (SANGA, dub mu-sar)
 x-mes-mes, No. 18
 x-na-GAM + GAM, No. 487
 [x]-pa-è, No. 475
 x-si-na, No. 122
 [x]-ti-x, No. 126
 x-x-ab-ra, No. 487
 [x-x-a]d, No. 474
 [x-x]-an-gār, No. 124 ([SANGA])
 x-x-BU, No. 283 (two different names)
 x-x-il, No. 142

DESCRIPTION OF FARA LITERARY AND LEXICAL TEXTS

Since no detailed description of the literary and lexical texts from Fara has been attempted in any systematic way since the first publication of the tablets by Deimel, and since no adequate descriptions were given by Jestin, it may prove useful to others who may work on texts of this

35. I owe this correction to A. Westenholz.

36. The same name occurs in No. 515, an administrative document. LAK 647 occurs in a Semitic name in *CT* XXXII, Pl. 8, col. ii, but with Ur- in the Names and Professions List. See No. 69 col. iii for a clear example. It is possible that it occurs also in D. J. Wiseman, *Catalogue of the Western Asiatic*

Seals in the British Museum I: Cylinder Seals, Uruk-Early Dynastic Periods (London, 1962) Pl. 14d. It perhaps occurs also in *OIP* XIV, No. 24 (door socket, not available for collation).

37. Misread as Pū-é in *Orientalia* n.s. XXXVI 65.

38. The occurrence in No. 142 was misread as Ša-ka-ma-il (*ibid.*).

period for me to describe each briefly, indicate joins, and list such duplicates and parallels as I am aware of.

In a few instances I have collated specific parts of texts published by Deimel, usually from photographs, which I owe to the courtesy of Dr. G. R. Meyer, Director of the Staatliche Museen in Berlin. Through the courtesy of Mrs. Muazzez Çiğ, curator of the tablet collection at the Archaeological Museum in Istanbul, I was able to collate all the literary and lexical tablets (and a number of the administrative texts) published by Jestin. In the case of the Istanbul Fara texts, it appears that they were copied hastily and not rechecked, for serious errors abound—grossly miscopied signs, lines omitted, conflated, reversed in sequence, edges of tablets not indicated, and the like. Without exception, every text I collated in Istanbul required correction.

SF

- SF 1. God list. Photo in *Fara II*, Pls. 2 and 3.
- SF 2. Small rounded tablet with names of gods.
- SF 3. Small fragment of god list.
- SF 4. Small fragment of god list.
- SF 5. List of gods on both sides of the tablet, with many names occurring on both sides. The obverse(?) is summed up as 51 dingir-dingir, "fifty-one gods." The summary, if any, on the reverse(?) is not preserved. This is perhaps an exercise tablet or else an offering list. Note the similarities to TŠŠ 629. Photo of obverse(?) in *Fara II*, Pl. 1.
- SF 6. List of gods on the obverse; the reverse has šu-nigín 28 / dingir ku₆-kú, "total: twenty-eight gods who consume fish (offerings)." Photo of obverse and reverse in *Fara II*, Pl. 1.
- SF 7. Mainly a list of signs in various combinations and basic forms of signs with modifications to make more complex signs.
- SF 8. Word list. Duplicate of the second part of SF 9.
- SF 9. Word list. This tablet includes two separate compositions. The first part, the fish list, ends in the gap following col. v l. 11. An earlier duplicate from Ur is *UET II*, No. 234, with some variants. It is also duplicated by IAS 10–12. Abū Šalābīkh duplicates of the second part include only the portions after col. v l. 15. The duplicates are IAS 13–17. A further duplicate, called to my attention by A. Westenholz, is A 3670 (provenience unknown; acquired by the Oriental Institute in 1920). The handwriting is slightly different from any I know from Fara or Tell Abū Šalābīkh, and the tablet therefore probably comes from another site. A long-known duplicate is that published by Louis Speleers in *Recueil des inscriptions de l'Asie Antérieure des Musées Royaux du Cinquantenaire à Bruxelles* (Brussels, 1925) No. 46.
- SF 10. Word list. Names of fish. Duplicates the fish section of SF 9, q.v.
- SF 11. Duplicate of SF 9 and 10.
- SF 12. Word list. Mainly domestic animals. A duplicate is TŠŠ 264. Edited in part with a later parallel by M. Civil, in *RA LX 11*.
- SF 13. Word list. Duplicate of SF 12.
- SF 14. Word list. Names of domestic animals, with numbers. Duplicate of SF 12 and 13, but with different numbers.
- SF 15. Word list. Partly names of foodstuffs and containers for measuring(?) them. Duplicate of SF 16, 17, and IAS 5 and 6. Photo in O. Neugebauer, *Exact Sciences in Antiquity* (2d ed.; New York, 1969) Pl. 4.
- SF 16. Word list. Duplicate of SF 15.
- SF 17. Word list. Duplicate of SF 15.
- SF 18. Literary. UD.GAL.NUN. It consists of two separate compositions on the same tablet. The first ends with ⁴Inanna zà-mì in col. vii l. 8, followed by a scribe's name. The second part

- is not followed by scribes' names. The second composition, separated by a double ruling, is duplicated by SF 19. Photo of obverse in *Fara II*, Pl. 4.
- SF 19. Literary. UD.GAL.NUN. Duplicate of the second part of SF 18. Photo in *Fara II*, Pl. 5.
- SF 20. Word list. Practical Vocabulary. Duplicates are SF 21, 22, and IAS 34.
- SF 21. Duplicate of SF 20.
- SF 22. Duplicate of SF 20 and 21.
- SF 23. Word list which begins with geographical names. Duplicate of SF 24; see also the description of the duplicate IAS 21.
- SF 24. Word list. Duplicate of SF 23. The deities are discussed by J. van Dijk, in *Acta Orientalia* XXVIII 7-8.
- SF 25. Poorly written exercise tablet.
- SF 26. Literary. Proverbs. Joins TSS 124. See Biggs, in *RA LXII* (1968) 95-96. Partly transliterated by M. Lambert, in *RA XLVII* 86. Duplicates of this composition are SF 27 and 65, TSS 124, 327, NTSS 294, and IAS 255. Some of the Fara fragments join, as indicated in the individual descriptions. See also n. 19 above.
- SF 27. Literary. Proverbs. Joins TSS 327. Join of NTSS 294 to the upper left corner was made by A. Westenholz.
- SF 28. Word list. List of names and professions. It is probably a small round tablet since the columns are short. Duplicates are SF 29 and 44.
- SF 29. Word list. List of names and professions. Duplicate of SF 28.
- SF 30. Exercise tablet, genre uncertain, but perhaps literary. Perhaps similar to SF 50*.
- SF 31. Exercise tablet, genre uncertain.
- SF 32. Presumably an exercise tablet, but not so designated by Deimel.
- SF 33. Standard Professions List, with colophon on reverse. Edited in *MSL XII* 8-12.
- SF 34. Duplicate of No. 33.
- SF 35. Duplicate of No. 33.
- SF 36. Literary. UD.GAL.NUN text, perhaps in praise of ^dSùd (see col. vii ll. 9-10). The possible cultic significance of this text was pointed out by Deimel, *Fara II* 24*.
- SF 37. Literary. UD.GAL.NUN. Duplicate of SF 38
- SF 38. Duplicate of No. 37. Joins NTSS 117 + 314 (join made by A. Westenholz on the basis of photographs).
- SF 39. Literary. UD.GAL.NUN.
- SF 40. Literary, concerned with Enki. There are frequent occurrences of gú si-ba-ra, "sounded the horn" (see also IAS 282), as well as zi-ga ba-gar. Kullaba (written Kul-UNUG) occurs in cols. ii and iv. A number of the lines appear to be intelligible. See M. Lambert's description of the text, in *RA XLVII* 143, "phrases provenant visiblement de récits littéraires."
- SF 41. Word list whose nature is not clear to me. A duplicate is TSS 193; partial duplicates are SF 42 and 49. Described by M. Lambert, in *RA XLVII* 142, as a syllabary.
- SF 42. Word list, nature uncertain. The last four lines are the colophon. Partial duplicate of SF 41 and 49.
- SF 43. Word list. Parts seem to be sequences of groups of signs in various combinations (e.g., gur, kuš, sfg, sum), and it is perhaps a Practical Vocabulary. Cf. SF 20-22 and 74.
- SF 44. Duplicate of SF 28 and 29 with some variants (not collated).
- SF 45. Perhaps literary. Note that the columns are very short, suggesting a rounded exercise tablet.
- SF 46. Incantation (see *JCS XX* 78, n. 41). Note šà-gig, libiš-gig, and occurrences of ^dNin-girim (written ^dNin-A.ĦA.MUŠ.DU).
- SF 47. List of professions. Edited by M. Civil, in *MSL XII* 14-15. See also M. Lambert, in *RA XLVII* 142.

- SF 48. List of professions. Edited by M. Civil, in *MSL* XII 15–16.
- SF 49. Duplicate of SF 42.
- SF 49*. Small fragment.
- SF 50. Exercise tablet, literary. Some lines duplicated in SF 52. Photo of obverse and reverse in *Fara* II, Pl. 8.
- SF 50*. Probably an exercise tablet. Perhaps similar to SF 30.
- SF 51. Probably an exercise tablet. Genre uncertain.
- SF 52. Probably an exercise tablet, literary. See also SF 50. Photo of obverse and reverse in *Fara* II, Pl. 6.
- SF 53. Probably an exercise tablet. Genre uncertain.
- SF 54. Collections of incantations on a small rounded tablet. See Biggs, in *JCS* XX 78, n. 41, and J. van Dijk, *Heidelberger Studien zum alten Orient* (Wiesbaden, 1967) p. 238. A number of the lines are readily intelligible. Duplicate of TSS 170.
- SF 55. Literary. UD.GAL.NUN. Note kēš sig₄-tu, “Kesh, the brick of birthgiving,” in col. ii l. 2. Cf. SF 56, also IAS 123.
- SF 56. Literary. UD.GAL.NUN. Cf. NTSS 82 for a parallel to the end of the composition.
- SF 57. Word list, at least in part a list of names of temple or palace personnel. The text ends in many lines with ME (see comments of Edzard, in *ZA* LV [1963] 102). Duplicates are IAS 44–53. There are numerous variants.
- SF 58. Word list. Until the SUM section, the entries seem to include literary phrases, even though (as is clear from the duplicates) the second part is a list of aliaceous plants and garden plants. The bird section is not included in the duplicates and is probably a separate composition. Duplicates are SF 67, NTSS 123, and IAS 23 and 24. Partly edited by M. Civil and Biggs, with an Old Babylonian duplicate, in *RA* LX 8–11. A later duplicate from Nippur is 6 NT 933.
- SF 59. Word list. Some of the words are clearly names of professions, some of which duplicate ones in the Standard Professions List (SF 33 and duplicates).
- SF 60. Literary. UD.GAL.NUN.
- SF 61. Word list(?).
- SF 62. Word list. It is possible that some of the lines give readings for signs or for CVC signs which may have a short reading. Cf. nam-ga-lam / nam-gál-la, obv. i 2–3, also x rim-rim / [na]m-erim, ll. 7–8, ni-ni-li, obv. ii 3, zal-za, l. 7. See also M. Lambert, in *RA* XLVII 86.
- SF 63. Probably a list similar to SF 62. Note dal-dál / dar-dal / da-da, col. i ll. 2–4. Also šir-šir / šir-šir, col. v ll. 17–18, me-nu-ḫal-ḫal / [me]-nu-ḫa-lam, col. ix ll. 14–15. Photo of obverse and reverse in *Fara* II, Pls. 6 and 7.
- SF 64. List of signs. An earlier duplicate is *OECT* VII (London, 1928) No. 195 (see Langdon, in *Journal of the Royal Asiatic Society*, 1931, p. 842). Duplicates are IAS 4, 7, 8, and 9. Some of the signs occur only in this text.
- SF 65. Probably an exercise tablet. Literary. Proverbs. See SF 26 for a list of duplicates.
- SF 66. Small fragment. Genre uncertain.
- SF 67. Word list. Duplicate of SF 58.
- SF 68. Small fragment, probably a list of wooden objects.
- SF 69. Word list. Perhaps more than one composition is represented. The first eight lines are reminiscent of the beginning of SF 58, but the rest of the text is not similar. Part of the text has lines repeated several times.
- SF 70. List of professions. Edited by M. Civil, in *MSL* XII 13–14.
- SF 71. Incantation. First identified by Falkenstein, in *Compte rendu de la Seconde Rencontre Assyriologique Internationale*, p. 19. Col. i l. 6 (transliterated nin-lil) has Nin-KID (collated).
- SF 72. Probably a word list.

- SF 73. Small fragment of a colophon.
- SF 74. Small fragment listing wooden objects. Perhaps part of a Practical Vocabulary. Cf. SF 20–22 or 43 (Practical Vocabulary).
- SF 75. Standard Professions List. Duplicate of SF 33, etc.
- SF 76. Small rounded exercise tablet. Excerpt from the Standard Professions List. There is a design on the reverse. Photo of obverse and reverse in *Fara* II, Pl. 8.
- SF 77. Word list of the same type as SF 62 and 63. Edited by R. Jestin, “Übungen im Edubba,” *ZA* LI (1955) 37–44, and by M. Lambert, in *RA* XLVII 84–85. Note such groups as nisabasa / nu-su-bu-še, bün-ni-ti / bu-ni-ti, ur-ur / ku-ur / ku(š)-ú / ku-ú. Photo of reverse in E. Heinrich, *Fara: Ergebnisse der Ausgrabung der Deutschen Orient-Gesellschaft in Fara und Abu Hatab, 1902/03*, Pl. 28.
- SF 78. Exercise tablet, literary. Note that ku-li with Ama-ušum-gal-an occurs also in IAS 278. VAT 9128 rev. (no edition number). Fragment of a colophon.
- SF 79. Exercise tablet. Col. ii l. 2 has giš-ub (collated).
- SF 80. Exercise tablet.
- SF 81. List of domestic animals. Duplicates are IAS 25 and 26. Cf. IAS 27 and 28. See photo, *Fara* II, Pl. 7. See also the comments of Biggs, in *JCS* XX 84, n. 78.
- SF 82. Mathematical text.

TŠŠ

- TŠŠ 46. Literary text. The left and right edges are preserved, though not indicated in the copy (Pl. 183), and the top is preserved in the last column on the right. In the second column from the right on the obverse, part of a line was omitted from the top. The lines nam-gi-zi and nam-anše are copied in the wrong sequence. The sequence of lines in the colophon on the reverse is partially incorrect. The correct line numbers, to be applied to the sequence as copied, are 1, 2, 3, 4, 8, 9, 5, 6, 7, 10, 11, 12, 13, 14, 15 (the ruling between the last two was omitted in the copy).
- TŠŠ 79. Literary. UD.GAL.NUN. It is probably the same tablet as TŠŠ 80, but they do not join. The top of TŠŠ 79 and the bottom of TŠŠ 80, as well as the left edge of both, are preserved. Both have a light vertical line in the center of all the columns, like that in SF 39. For the introductory formula, u₄-ri, see J. van Dijk, in *Acta Orientalia* XXVIII 31–34 and Biggs, in *JCS* XX 81.
- TŠŠ 80. Literary. UD.GAL.NUN. See TŠŠ 79. The reverse has a colophon.
- TŠŠ 124. Literary. Proverbs. Joins SF 26. See Biggs, in *RA* LXII 95–96. The right edge and the top are preserved. There are three columns, not four, on the reverse, but the column farthest to the right was omitted in Jestin’s copy. The last column is the colophon.
- TŠŠ 126. Literary. There are many parallels to the reverse in IAS 324 and 325. The copy in TŠŠ is seriously defective, particularly the obverse. The column on the left edge was omitted entirely; a line was omitted in col. i (gal lagab nun lagab, to be inserted following line 6); most of col. ii is legible, in spite of the copy; part of col. v (not indicated in the copy) is legible. The thickest part of the reverse is between columns iii and iv at line 9 of column iii. It is necessary to assume that the sequence of columns on the reverse is left to right and that IAS 325 is also a reverse, but with the column sequence right to left. Since there are numerous differences between the two main texts, I give here results of my collations for the parts that are parallel (including some lines which were correctly copied, but possibly ambiguous because of superfluous shading).

rev. col. i (numbering from the left)

- 1 x-ḥal-ḥal
- 2 gfn-nu-kud
- 3 me-tag nu kud
- 4 ṛnīg¹(?) du₆(?) ib lam ki
- 5 ni-šu-du₈
- 6 ga-šu-du₈ (as copied)
- 7 še-nun en pa lá ki KINDA + KI(?)
- 8 amar-tùr lagab
- 9 sur TA + GIŠ si (as copied)
- 10 as copied

col. ii (differs substantially from Abū Šalābīkh version)

- 1 ^dInanna-AMA-me
- 2 as copied
- 15 pa má

18 and 19 to be reversed in order

col. iii

- 1 nu tu aš
- 2 nám-mu-gá
- 3 as copied
- 4 GAM + GAM nagar
- 5-8 as copied
- 9 gug máš sumaš(LAK 226)
- 10 as copied
- 11 a[k(?)]-nun
- 12 x LAK 442
- 13 LAK 442
- 14 as copied
- 15 PA (two separate strokes for verticals)
- 16 as copied
- 17 maš maš
- 18 bu(?) lagab lagab

col. iv

- 1 gudu nun-dall[a](?)
- 2-5 as copied
- 6 an dūr kar ud
- 7 du₁₀ mu KA x x
- 8-9 as copied
- 10 ḥur-ḥur-m[u](or š[e])
- 11 as copied
- 12-13 (one line) šaḥ ḥur(?) sig₄ ka sur [(x)]
- 14 nun x
- 15 as copied
- 16 gig x x (bottom line)

TŠ 168. Joined to other fragments. See NTŠ 168.

TŠ 170. Incantations. Both left and right edges are preserved. There are four columns on the reverse, approximately as well preserved as the obverse, which were not copied. Duplicates and parallels SF 54. Note that instead of am in am-sila₄ / am-NE in SF 54 vi 2-3, TŠ 170 has

- áb. This incantation is continued on the reverse of TSS 170. Note the apparent reference to a "great midwife" in rev. i 4: 'šà¹-zu-gal / kul-ab a KA × LI-[d]a (all in one line in SF 54 vi 7). The incantations are not in the same sequence in the two tablets, and there are some textual variants. It is probable that all incantation texts from Fara are on small rounded tablets such as this one. This would seem to set them apart from the traditional works of scholarship which are on rectangular tablets.
- TSS 193. Word list. Duplicate of SF 41, etc. There are three columns, but the left column was not copied by Jestin. Since it helps to restore SF 41, I give it here with line numbers from SF 41: l. 9, k]a; l. 10,] za_x -du; l. 11,] ki; l. 12,] ki; l. 13,] SANGA. The unusual form of NE in col. ii is correct as copied. Col. iii has $\frac{21}{21}$.A.TÚ[G], NI.TÚG.GAD[A], etc. The bottom edge of the tablet is preserved.
- TSS 194. Probably a literary text. The top edge is preserved. More can be read in the lower third of col. ii and in col. iii than the copy indicates.
- TSS 264. Word list. Duplicate of SF 12, etc. The fragment has the top and left edges preserved. Significant errors in the copy are: line 4 reads nun me du; line 5, inside PISAN is MUN.
- TSS 269. The obv. is in TSS, Pl. 92 and the rev. in TSS, Pl. 97. It is now joined to other fragments. See NTSS 168.
- TSS 271. Probably a literary fragment.
- TSS 327. Proverbs. Joins SF 27. See description of SF 26.
- TSS 845. Erroneous number; the correct number is 846. Literary. The fragment has the bottom and right edges preserved.
- TSS 973. Erroneous number; the correct number is 972. The obverse, badly damaged, is unpublished. The reverse includes a design and the colophon. The first preserved name in the colophon is [SANGA a]silal [x] x. In the next to the last line the sign SANGA is preserved. Apparently a fragment with the remainder of two columns (which has the bottom edge preserved) has been joined to the lower right since the tablet was copied.
- TSS 984. Genre uncertain. The bottom and right edges are preserved. The "new sign," listed by Jestin under "Signes nouveaux" (following plates), TSS, p. 8, No. 84, is sig written over an erasure.
- TSS 1003. Perhaps a list of names and professions. The tablet is unusually thick. The reverse is uninscribed.

NTSS

- NTSS 82. Literary, perhaps UD.GAL.NUN. The tablet (NTSS, Pl. 34) measures 26 × 29 cm. A fragment of the left edge is preserved in Š 333, which I joined to this tablet in the summer of 1972, making it certain that the first column of the copy is the first column of the composition. Both top and bottom edges are preserved. There is a light vertical line in the middle of each column, omitted in the copy. The colophon was probably on the left side of the reverse, but the area is destroyed. The published copy is seriously defective, with many signs miscopied or omitted. In column v, lines 6 and 7 are copied in the wrong sequence as are lines 6 and 7 in column ix. The end of the text is paralleled by SF 56, NTSS 168, and IAS 123 and 153.
- NTSS 117 + 314. Literary. UD.GAL.NUN. The bottom edge of the tablet is preserved. There are a number of errors and omissions in the copy. The thickest point on the reverse is between columns iii and iv at lines 11 and 12. It joins SF 38 (join made by A. Westenholz on the basis of photographs).
- NTSS 123. List of plants, etc. Duplicate of SF 58, q.v. On the obverse the most significant errors in copying are: col. ii l. 2, the top GI sign in the copy is GÍN; l. 3, read gín si kéš; l. 10,

the sign in the upper left is gur; col. iii l. 3, add igi; ll. 4–5, add a vertical wedge inside im (as in the duplicates, im does not have the verticals crossing the horizontal wedge); l. 6, read gi_4 instead of gi. On the reverse the right edge and top are preserved. The traces in the right column (not copied) are mostly illegible. The top of column ii corresponds to SF 58 ii 23. It reads kun-me-te; l. 2, kúš lú-PA-[x] x; l. 10, an- hu - ti^1 ; l. 12, as in SF 58 except that sag is not preserved. The rest of column ii differs from SF 58; col. iii ll. 9–10, ku_7 , not ab; it is followed by a line šè-ku_7 -sum (omitted in the copy); at the bottom of the column, below $\text{SAL} + \text{TUK}$ -sum, is a line [x x]-dar; col. iv l. 1, nagar-sar; l. 10, ku_7 -sum; col. v l. 4, [x] šakir-sar. The thickest part of the reverse is in column iii at lines 9 and 10.

NTSŠ 148. Literary. Reverse destroyed.

NTSŠ 168. Literary. Parts of this tablet were published in TSS. With few exceptions, only the newly added parts of the tablet were copied by Jestin in NTSŠ. It is therefore difficult to know the location of fragments without recourse to the original tablet. The fragment shown in the lower left of NTSŠ, Pl. 33 (its museum number is 980) does not join the tablet where it might appear to from its location on the plate. The left side is the left edge of the tablet; the lower edge of the tablet is preserved at the bottom of column ii; hence the fragment is the lower left corner of the entire tablet. The right side of 980 joins the left side of TSS 168, of which the lower edge (in spite of the copy) is preserved for the first two columns, which are consequently columns iii and iv of the tablet. Consequently, all four edges of the tablet are preserved at least partially. The end of the composition is preserved on the reverse right side (published as TSS 269 rev. on Pl. 97). It reads $\text{men ub ru} / \text{men tuk nisaba LAK 654 lul} / \text{nisaba zu}_x(\text{AZU})$ $\text{EZEN} \times \text{AN} / \text{EZEN} \times \text{AN E}[\text{ZEN} \times \text{AN}] /$ (traces of last line). (Similar passages occurring at the end of compositions are SF 56, NTSŠ 82, and IAS 123 and 153.) The colophon was on the left side of the reverse, but, besides SANGA, only traces remain. Numerous additions and corrections (including omitted lines and signs) are required.

NTSŠ 229. Only the reverse with a colophon is preserved. Parts of the SANGA sign are preserved in some of the lines.

NTSŠ 294. Literary. The left edge and bottom edge are preserved. The reverse has a colophon.

IV

THE ADMINISTRATIVE TEXTS

SINCE a large proportion of the published texts from Fara are administrative, there is a sufficient number that observations on agricultural work and products, work crews, medium of payment, the occupations exercised at Shuruppak, and the like could be made by Deimel and by M. Lambert.¹ Nevertheless, in spite of several hundred well-preserved documents, it has proved extremely difficult to analyze the evidence provided by the texts to give a coherent picture of the city and countryside. The difficulties arise from several factors in addition to the usual uncertainties of reading the script. First, with few exceptions, it is not possible on the basis of published information to know which tablets were found together. Consequently, if it is assumed that all of the Fara tablets belong to one archive and are all contemporary, analysis of the published data cannot yield valid results.² A second major difficulty is that the texts are usually extremely concise so that even if every word is understood, one must often guess what the purpose of the text was.³ Only in rare instances are verbs employed to indicate the action being recorded. The most common expression is *šu-ba₄-ti* or *šu-ba-ti*, "received," for example, 82 *guruš x zíd šu-ba-ti*, "82 workmen received x flour" (WF 98 col. vii; cf. WF 99; also TŠŠ 50 [mathematical text], 81, 368, 630, 881; in a few instances there is a verb for "gave out": *šu-sum* (TŠŠ 102), *šu-ba-sum* (TŠŠ 411), *šu-sum-ma* (TŠŠ 826). In one instance the verb is *šu-gál*, probably "remains on hand" (TŠŠ 160). In nearly all other instances we lack this information. No text is dated, and usually no indication is given of the time span covered by any particular document. A third difficulty is that considerable areas of activity are apparently not covered by the administrative texts. For example, one may not be justified in concluding that cattle were of little economic importance at Shuruppak (asses are mentioned much more frequently), for, depending on who owned them and under what conditions, there may seldom have been occasion for administrative documents to mention cattle any more than milk products, garden vegetables, and the like.

Compared with Fara, the yield in administrative documents at Tell Abū Šalābīkh has been meager indeed, and the few found are mostly very fragmentary. The texts found in room 31 with the hoard of literary and lexical tablets should certainly be considered contemporary with them. Some administrative documents, in fact, mention persons listed in the colophons of the literary and lexical texts. Several of the documents give the appearance of being earlier than others, although this may be due rather to the fact that they were written by different scribes.⁴ In any case, several loci are involved (see the Index of Field Numbers for the findspots).

On the basis of the few available tablets, it would be difficult to determine the nature of the archive (or, more likely, archives) to which the tablets belonged. Some tablets are concerned with

1. Principally in *Fara* III 9*-17* and "La période présargonique: La vie économique à Shuruppak," *Sumer* IX (1953) 198-213 and *Sumer* X (1954) 150-90.

2. Harriet Osborn has been able, in a number of instances, to identify findspots for some of the tablets on the basis of records in the Vorderasiatische Museum in Berlin ("Fara: An Archaeological Study of a Third Millennium City, Its

Internal Development and External Relations," [Ph.D. diss., University of Chicago, 1971]).

3. An example is provided by M. Lambert, in *Sumer* IX 203-4, in his discussion of draft asses where one cannot be sure who owns them—a city authority, a wealthy individual, or the person working them.

4. Note that the scribe A-rá in IAS 494 is not among those listed in the colophons.

scribes who presumably worked in the same building. For other individuals, there is no specific evidence of where they worked. Some documents concern the issue of various items, particularly foodstuffs, and consequently would presumably come from an administrative office, as would those concerning draft animals. Mention of the lugal, "king," and ensi₂, "governor," suggests that the source of the tablets was the administrative office of some city authority. I can see no specific evidence in the texts which would clearly decide the matter in favor of either a temple adjunct or a palace office.⁵ On the other hand, they are clearly not the archives of a private person or family.

A number of sale contracts concerning real estate were found at Fara.⁶ None have been found at Tell Abū Šalābīkh. Several of the Abū Šalābīkh texts concern barley, usually barley rations. Unlike Fara texts, none use the capacity measure ni-ga.⁷ As at Fara, "total" is expressed either as GÚ.AN.ŠÈ (reading unknown) or šu-nigín. In Abū Šalābīkh texts šu-nigín occurs in a higher proportion, but with such a small number of texts this is probably statistically insignificant.⁸

The official(?) designated ensi₂.GAR is attested frequently in Fara texts (the meaning is unknown),⁹ but the ensi₂ only once, and then indirectly (assuming the order of the signs is correct), in WF 71 col. v. At Abū Šalābīkh an ensi₂, whose name is not given, is mentioned in IAS 508. The ensi₂.GAR does not occur in the administrative texts. There may have been a lugal, "king," at Abū Šalābīkh (see IAS 494 and 503).

One of the Abū Šalābīkh fragments (IAS 508) is of special interest if my tentative conclusion that it is written in Akkadian is correct. There is first of all a problem in identifying the obverse and reverse. The flat side (which would normally be considered the obverse) has GÚ.AN.ŠÈ, "total," as the first line in the left column and would, on this basis, be taken as the reverse. Nevertheless, the double vertical rulings on the rounded side and the distribution of the writing suggest strongly that it is the reverse of the tablet. If this is the case, the flat side must indeed be the obverse, but the columns proceed from right to left! I tentatively interpret *in* Ur₄^{K1}, which occurs twice on the round side, as "in (the town) Ur₄."¹⁰ Note furthermore the occurrence of ù, perhaps to be interpreted as Akkadian "and."

5. See ch. 1 for Donald Hansen's more explicit opinion based on other criteria.

6. Edited by D. O. Edzard, *Sumerische Rechtsurkunden des III. Jahrtausends aus der Zeit vor der III. Dynastie von Ur* ("Abhandlungen der Bayerischen Akademie der Wissenschaften," Philos.-hist. Kl., N.F. LXVII [Munich, 1968]) especially pp. 18–22. See now also M. Lambert, "Quatre nouveaux contrats de l'époque de Shuruppak," *In memoriam Eckhard Unger: Beiträge zu Geschichte, Kultur und Religion des alten Orients*, ed. Manfred Lurker (Baden-Baden, 1971) pp. 27–49.

7. See I. J. Gelb, "The Philadelphia Onion Archive," *Studies in Honor of Benno Landsberger* ("Assyriological Studies,"

No. 16 [Chicago, 1965]) p. 58, and Edzard, *Sumerische Rechtsurkunden*, p. 19.

8. There appears to be no distinction between GÚ.AN.ŠÈ and šu-nigín, since there is free variation even in identical contexts.

9. See W. W. Hallo, *Early Mesopotamian Royal Titles: A Philologic and Historical Analysis* ("American Oriental Series," No. 43 [New Haven, 1957]) pp. 35–39, and Edzard, in *Journal of Semitic Studies* IV (1959) 378–79.

10. For other occurrences of *in* in pre-Sargonic inscriptions, see I. J. Gelb, *MAD* No. 3, p. 49. (The reference to the unpublished text A 25412 is to be deleted, as I. J. Gelb pointed out to me.) Occurrence of an Akkadian preposition would suggest that these texts were written to be read as Akkadian, even though they have occasional Sumerian verbal forms.

V

TRANSLITERATED TEXTS

SEVERAL compositions are given here in transliteration, and critical editions are provided. The choice of compositions to treat in this manner was based upon the fact that for several of these, there are numerous sources from Tell Abū Ṣalābīkh. In the case of the Instructions of Shuruppak, it seemed of interest to demonstrate the relationship of the archaic orthography to the Old Babylonian orthography. Only the sections of the composition for which it was possible to recognize a parallel in the Old Babylonian Sumerian version are given.

THE ZÀ-MÌ HYMNS

The hymns edited here, to which I have given the convenient designation zà-mì (corresponding to zà-mì, “praise,” in the later Sumerian orthography), seem to be in the tradition of the Sumerian Temple Hymns and the Kesh Temple Hymn.¹ The collection of hymns edited here is so far known only at Tell Abū Ṣalābīkh.

The first fourteen lines of the composition are probably to be considered a prologue, somewhat like the prologue (also referring to Enlil) in the Kesh Temple Hymn.² The prologue begins with a description of Nippur: “city growing skyward, embracing the heavens, Nippur, the bond between heaven and earth,” followed by the name of Enlil with his common epithet “great mountain” with other epithets less comprehensible. The prologue contains one of the few finite verbs in the entire composition: zà-mì mu-du₁₁, “spoke the praise.” It is therefore probable that the rest of the text should be understood as praise uttered by Enlil.

Normally a divine name comes before zà-mì, but there are some cases where there is no divine determinative. Deities whose cult cities are near each other are often in proximity in the hymn as well, but since deities from Uruk/Kullaba occur in three widely separated parts of the hymn collection, it is clear that the principle of organization was not mainly geographical. Deities known from myths and epics to be in a close relationship are often grouped together in the hymn collection. A number of the deities are attested elsewhere only in the lists of deities from Fara and Tell Abū Ṣalābīkh.

The critical edition given here should be considered only the first step toward understanding and eventually translating these very difficult texts. It should be stressed that the values used for the signs in the transliteration are not necessarily intended to indicate my understanding of the word or phrase in question, but merely to indicate what sign is in the text. Since in many instances the proper sequence of the signs is unknown, it is possible that the typographical necessity of putting the signs one after another in a line will prejudice our understanding because of the particular sequence chosen. The signs can be rearranged within a line in any sequence which gives sense. One must bear in mind, however, that a chosen sequence may make sense to us and nevertheless not be the sequence intended by the scribe. The risk of misinterpretation is distinctly higher in lines which have a sign which can be taken as a determinative (e.g., AN/DINGIR). In

1. *TCS* III (1969) 157-88.

2. *Ibid.*, p. 167, ll. 1-12.

looking at the transliteration, one may be tempted to put an and ki together and read an-ki "heaven and underworld," but, although it is an obvious combination, it may often not be correct. Particular account should be taken of the variants. Omission of DINGIR is easily explained if it is a determinative, but not if it is to be read an or dingir. I have used hyphens in the transliteration when I believed the sequence of signs to be reasonably assured.

With the exception of lines 188–91, where there is great difficulty in combining the few fragmentary sources, it has been possible to reconstruct the entire composition with only a few signs missing. Because some of the texts have zà-mì on a separate line and some do not, I have arbitrarily included zà-mì with the last line of each hymn and assigned the line numbers accordingly in order to give a uniform line numbering to all the manuscripts.

SOURCES

| | | | |
|-----------|-----------|------------------------|-----------|
| A No. 266 | G No. 271 | L ₁ No. 275 | O No. 264 |
| B No. 268 | H No. 258 | L ₂ No. 276 | P No. 261 |
| C No. 267 | I No. 274 | L ₃ No. 277 | Q No. 270 |
| D No. 269 | J No. 259 | M No. 272 | R No. 262 |
| E No. 257 | K No. 273 | N No. 260 | S No. 263 |
| F No. 265 | | | |

TRANSLITERATION

| | | |
|-------|----|--------------------------------------|
| AE | 1 | uru an-da mú |
| AE | 2 | an-da gú-lá |
| AE | 3 | dingir EN. LÍL. KI |
| AEQ | 4 | dur-an-ki |
| AEQ | 5 | ⁴ En-líl kur-gal |
| AEQ | 6 | ⁴ En-líl nu en |
| ACE | 7 | nam-nir |
| ACE | 8 | en du ₁₁ -ga |
| ACE | 9 | nu gi ₄ -gi ₄ |
| ACH | 10 | LAK 809 nu LAK 809 |
| AH | 11 | ⁴ En-líl a-nun |
| ADH | 12 | ki mu-gar-gar |
| ADGH | 13 | dingir-gal-gal |
| ACDGH | 14 | zà-mì mu-du ₁₁ |
| ACDGH | 15 | unug LAK 31 maš |
| ACDGH | 16 | Kul-aba(UNUG) |
| ADGH | 17 | an ki en tu |
| ADG | 18 | ⁴ Nin-unug zà-mì |
| ADG | 19 | ša-é sig ₄ -Kul-aba(UNUG) |
| A | 20 | en-nun tu-tu |
| A | 21 | IN[ANNA] giš [b]íl |
| C | 22 | [x x] tu-[tu] |
| CE | 23 | ⁴ Inanna bfl |

3. E omits DINGIR.

6. A nu en probably included with line 7.

16. C UNUG written over erased(?) kul.

17. D omits an; with line 16 in G.

| | | |
|---------|----|---|
| ACEGQ | 24 | x til |
| ACEGQ | 25 | an-kisal |
| ACEGQ | 26 | an-ki-kisal |
| ACEG | 27 | Kul-aba(UNUG) an-gim |
| ACEG | 28 | šu nu ti |
| ACEG | 29 | ^d Inanna zà-mì |
| ACEH | 30 | abzu ki-kur-gal |
| ABCEH | 31 | men-nun an-ki |
| BCEH | 32 | ^d En te ʰu nu du ₁₀ zà-mì |
| ABCH | 33 | ḪA.A nun-ir |
| ABCH | 34 | ^d Asal-lú-KAL zà-mì |
| ABCDH | 35 | Uri _x (šEš.UNUG) šim-kur |
| ABCDGHP | 36 | lugal ^d Nanna zà-mì |
| ADG | 37 | é ^d Utu NINDA ₂ × GUD gišgal |
| ADG | 38 | lugal ^d Utu zà-mì |
| ACDG | 39 | ki-sar-nun-tu-tu |
| ACDG | 40 | ama ^d Nin-gal zà-mì |
| ACDG | 41 | IGI + SILA ₄ (?) gal-gal gi nim |
| ACE | 42 | dag lú kal an ga |
| CE | 43 | An zà-mì |
| ACE | 44 | egir ʰu an-ki NUN ^{ki} |
| ACEH | 45 | ^d Dam-gal-nun zà-mì |
| ABCEH | 46 | ^d Inanna kur |
| ABCEH | 47 | kur ki-sikil |
| ABCEH | 48 | INANNA.UNUG ban-kù-lá |
| ABCEH | 49 | kar gur ₇ -gur ₇ -nun Zabalam(INANNA.AB) |
| ABCH | 50 | ^d Inanna ʰu ud |
| ABCH | 51 | ^d Nin-um zà-mì |
| ABCH | 52 |  gíḫ kalam |
| ABC | 53 | mar-uru ₅ ud |
| ABC | 54 | am-gal-nun zà-mì |
| ABDG | 55 | A. ḪA úr NINDA ₂ × GUD ud |
| ABDG | 56 | aš-DU-UD zà-mì |
| ACDG | 57 | ub LAK 31 ud |
| ACDG | 58 | ban-kù-lá zà-mì |

36. A written lugal šEš an KI; D trace of an additional sign.

37. Text from D; A has ^ré¹ ^dUtu [NINDA × GU]_D × DU; G UD. UD for UD.

38. D omits DINGIR.

40. A, C, D omit DINGIR; G adds gar.

41. A, C clearly have IGI + DIB, i.e., ù; D has IGI + SILA₄(?).

42. A, C omit an.

48. A, H AB for UNUG.

49. Text from A, B, H; C, E have bù(KA × ŠU) for gur₇-gur₇.

50. A RI instead of ʰu.

| | | |
|--------|----|--|
| ACDG | 59 | rad mul ħur |
| ACD | 60 | ^d Nin-mar lá-lá za-za _x kù |
| ACDE | 61 | buranun kaskal nun bar |
| ACDEH | 62 | idigna buranun |
| ACDEH | 63 | ħur-ħur-du |
| ABCDEH | 64 | ^d Nin-bí-lu-lu zà-mì |
| | | |
| ABCEH | 65 | gìr.UNUG |
| ABCEH | 66 | dag-gal an-ki |
| ABCEH | 67 | gissu sig |
| ABCEH | 68 | ^d En-ki ^d Nin-ki |
| ABCH | 69 | ^d Gìr.UNUG zà-mì |
| | | |
| ABC | 70 | kiš gud-du ₇ |
| ABC | 71 | ^d Za-ba ₄ -ba ₄ zà-mì |
| | | |
| ABC | 72 | UD.NUN nìr BU.NUN |
| AB | 73 | an nì ab kuš |
| AB | 74 | ^d šÁR × DÍš-gi ₄ zà-mì |
| | | |
| AB | 75 | kèš sig ₄ -tu-tu |
| ABC | 76 | é-tu ^{mušen} -gùn-tur |
| ABC | 77 | ama ^d Nin-tu zà-mì |
| | | |
| ABC | 78 | gi en ki ki-sikil |
| ABCDH | 79 | ^d Mes-sanga-unug zà-mì |
| | | |
| CDH | 80 | an gudu ₄ dumu-nun |
| ACDEH | 81 | kisal en an-da mú |
| ABCDEH | 82 | ^d Men zà-mì |
| | | |
| ABCDEH | 83 | gi en ki zalag ₂ kù |
| ABCDEH | 84 | lamma ^d Nin-sún zà-mì |
| | | |
| ABCDEH | 85 | ba ₄ amar kù ub nun |
| ABCDH | 86 | ^d Lugal-bàn-da zà-mì |
| | | |
| ABCK | 87 | IM tí še gu |
| ABCK | 88 | ^d IM zà-mì |
| | | |
| ABCK | 89 | LAK 4 nun Ereš ₂ (NISABA) ^{ki} |
| ABC | 90 | NISABA nun ta tuku te lul |
| AB | 91 | ^d Nisaba zà-mì |

59. A mar instead of rad.

60. A za-za_x(LAK 798); C za-za; C omits mar; D rad for mar.

61. C, D omit bar; E adds KI (i.e., UD.KIB.NUN.KI).

62. C, E add KI.

66. With line 65 in all copies except A.

69. C probably AB for UNUG.

71. B za_x(LAK 798).74. B gi for gi₄.

77. A, C omit nin.

79. H dub for mes.

83. B omits ki.

86. B omits DINGIR.

THE ZA-MÌ HYMNS

| | | |
|---------------------|-----|--|
| AB | 92 | nagar NAGAR. GÍD nun |
| AB | 93 | gín še + GUG |
| AB | 94 | gín 'šim ¹ |
| BC | 95 | šum kù-babbar |
| BC | 96 | bulug _x (NAGAR) za _x (LAK 798)-gin |
| BC | 97 | ^d Nin-ildumma(NAGAR. GÍD) zà-mì |
| BCL ₁ | 98 | kar LAK 159 a dé-dé |
| BCL ₁ | 99 | ^d Ab-gíd-gíd zà-mì |
| ABCDEL ₁ | 100 | AB × Aš a šuš u ₅ |
| ABCDEL ₁ | 101 | ^d Ki-ki-ḥu zà-mì |
| ABCDU | 102 | AB × šuš LAK 31 gal-gal |
| ABCD | 103 | kù ^d Ašnan zà-mì |
| ABCD | 104 | Umma(GIŠ. ùḪ) ur ₄ -sal |
| ABCDK | 105 | ^d Nin-ur ₄ zà-mì |
| ABCDK | 106 | an ki gud x é sag-dar |
| BCK | 107 | ^d Šara zà-mì |
| BC | 108 | Lagaš im-ku ₇ |
| BC | 109 | ^d Gá-tùm-dùg zà-mì |
| BC | 110 | nanše nagar an áb |
| BC | 111 | ^d Nanše tag |
| BC | 112 | NINDA ₂ × GUD nagar |
| BCL ₁ | 113 | ^d Nin mu mes ḪU |
| BCL ₁ | 114 | an nin-uru _x (EN) mes |
| BCL ₁ | 115 | nin ab mes ḪU |
| BCL ₁ | 116 | ^d Nanše zà-mì |
| BCL ₁ | 117 | gír-su |
| BCEJ | 118 | é-gír-nun |
| BCJ | 119 | ^d Nin-gír-su zà-mì |
| BCJM | 120 | gublaga(EZEN × LA) NINDA ₂ × GUD dar |
| BCJM | 121 | ^d Nin-gublaga(EZEN × LA) zà-mì |
| ABCJM | 122 | ^{SAHAR} ^{SAHAR} gíd nun |
| ABCDIJK | 123 | ^{SAHAR} ^{SAHAR} ud gal |
| ABCDIK | 124 | giš muš gi kéš |

94. A illegible except for gín.

101. B [(x)] x 'ki¹ zà-mì; C [x] x 'ki¹ zà-mì; L₁ [x (x)] ḥu-ki zà-mì.

103. A kù ^dGI. TIR; B kù še. TIR; C, D kù ^dŠE. TIR.

105. B DINGIR omitted.

106. A an-gud é 'sila₄¹ x dar; B omits sag; C, D sag not preserved; sag-dar on separate line in K; é omitted in K.

110-11. B NANŠE written KU₇ × ḪA.

113. B um for mes.

115. B, C um for mes; transliteration based on assumption that L₁ had mes as in line 113; ḪU clear in B, apparently dar (but small horizontals not visible) in C, not preserved in L₁.

116. B NANŠE written KU₇ × ḪA.

119. B omits zà-mì.

123. I Final vertical wedge unaccounted for unless this line is omitted and the wedge is the final vertical of nun in line 122.

| | | |
|-------------------|-----|--|
| ABCDIK | 125 | sug suḥur suḥur |
| ABCDI | 126 | rí a lú du ₁₀ |
| ABCD | 127 | lugal an dùl du zà-mì |
| ABCDK | 128 | gi en ki |
| BC | 129 | áb anše x |
| BCKL ₁ | 130 | gu aš til |
| BCL ₁ | 131 | am gud ná |
| BCL ₁ | 132 | gu aš til |
| BC | 133 | am gú gi ₄ |
| BCF | 134 | še éš.BU.NUN ka kéš |
| BCF | 135 | im x |
| BCF | 136 | ur mi ná dam šè |
| BCF | 137 | ^a Nin-a-zu _x |
| BCJ | 138 | áb asal asal |
| BCJ | 139 | ^a Nin-a-zu _x zà-mì |
| BCJ | 140 | šu eš gi ti še gu |
| BCJ | 141 | ^a ENGUR zà-mì |
| BCIJ | 142 | ab- ^{KID} _{KID} |
| BCJ | 143 | ^a INANNA dilmun gal |
| BCJ | 144 | ^a Nin-ab- ^{KID} _{KID} zà-mì |
| BCDIJ | 145 | gú gán saḥar nun |
| BCDIJ | 146 | ^a Nam-nir zà-mì |
| BCI | 147 | gán gal da ni gar |
| BCI | 148 | gán nun gal zà-mì |
| BCI | 149 | lamma-an-ki |
| BC | 150 | ama unug(?) ga ḥé-nun |
| BC | 151 | ^a Lamma-ša ₆ -ga zà-mì |
| BF | 152 | BIL.GI NUN ^{kl} |
| BF | 153 | bar BIL.GI u ₆ -di |
| BF | 154 | u ₆ erím |
| BF | 155 | ti munsub |
| BCF | 156 | kù ^a BIL.GI zà-mì |
| BCF | 157 | an kurušda gud NINDA ₂ × GUD ḥu |
| BCJ | 158 | x gal du ₇ áb |
| BCJ | 159 | ^a En-gal-te tí zà-mì |

125. D and I add du₁₀ in very small script.

128. With 129 in C.

129. B x is probably é or kisal; x omitted in C.

133. With 132 in C (only end of TIL preserved for 132).

134. še omitted or not preserved in C.

137. Perhaps a trace of a following zu_x (the vertical ruling on the right is deep and wide at this point).

141. I omits zà-mì.

143. B probably omits gal; 143–44 omitted in I.

144. B omits zà-mì(?).

157. B R[r] for ḥu. Preceded by a line an kurušda zà-mì in C and J.

158. C gud for du₇.

159. B me for gal.

THE ZA-MI HYMNS

- BCJ** 160 A. HA. MUŠ. DU
BCJ 161 ir-ḥa-an MUŠ. DIN. DAR. BALAG
BCIJ 162 ⁴Nin-girim_x(A. HA. MUŠ. DU) zà-mì

BCIJ 163 áb-x áb-babbar
BCIJ 164 ⁴Nin-É-kù zà-mì

BCIJ 165 ki bal mar an
BCI 166 ⁴Nin-mar zà-mì

B 167 na-dù
BCI 168 ⁴Nin-kar-gal-na-dù
BCI 169 šir(LAK 24) é-nun-ta è zà-mì

BCL₁ 170 kaš din dù tu si é
BL₁ 171 ⁴Nin-kas-si-din zà-mì

BF 172 ab ^{KAR}_{KAR}
CF 173 ⁴Men
BCF 174 ⁴Inanna kur kù zà-mì

BCF 175 SÚN ⁴EZEN × KÙ
BCF 176 ⁴Nin-zadim zà-mì

BCFR 177 ab-NAGAR
BCJR 178 NAGAR an-ki
BCJR 179 ⁴Nin-sar zà-mì

BCJ 180 SU + KUR + RU ban nun kù
BCJ 181 ⁴Sùd nun zà-mì

BCJL₁ 182 PISAN × MUŠ gud nun me
BCIJL₁ 183 ⁴Nin-PISAN × MUŠ zà-mì

BCIL₁ 184 á NE en zu
BCIL₁P 185 ⁴Nin-á-NE zà-mì

CIL₁P 186 nagar an ki in
CI 187 ⁴Nin-in zà-mì

BCI 188 ni(?) a []
CI 189 an x []
190 missing
B 191 x
B 192 ⁴Nin-x-k[i](?) zà-mì

166. C rad for mar.

167. C probably omits this line; I omits this line.

168. Probably not room for na-dù in B.

169. I up and DU widely separated, perhaps not è.

177. With 178 in C and R.

182. me only in J.

184. I and L₁ (very clear) have da for á.185. L₁ da for á.

186. I li for in.

188. I perhaps gu a [x x].

| | | |
|-------------------------|-----|---|
| F | 193 | giš pi a x |
| F | 194 | en du ₁₀ |
| F | 195 | ^d Me-dfm-túm zà-mì |
| BFL₁ | 196 | sumaš anše ud |
| BFL₁ | 197 | ^d Lugal-SAḪAR-EZEN × AN zà-mì |
| BFJL₁ | 198 | Kisig(EZEN × SIG ₇ ^{kl}) |
| BJL₁ | 199 | ^d Nu-NUNUZ-du ₁₀ zà-mì |
| ABJ | 200 | en ban nun |
| ABJ | 201 | nimgir na-nam |
| ABCJ | 202 | ^d Lugal-kud-da zà-mì |
| ABJ | 203 | EZEN × NIMGIR(?) gukkal tu |
| ABCI | 204 | ^d Dam-mi zà-mì |
| BCINO | 205 | šÁR × DIŠ en KUŠ.A.EDIN nun |
| BCINO | 206 | nu en lú gíd zà-mì |
| BNO | 207 | gín(?) šà ga EZEN × AN |
| BL₂ | 208 | ^d Nin-al-šul zà-mì |
| BCL₂S | 209 | a-šà gíd |
| BCL₃S | 210 | men nun |
| BCL₃S | 211 | ^d Amar-engur-na zà-mì |
| BCL₃ | 212 | ki a an gi |
| BC | 213 | an ki en tu |
| BC | 214 | ^d Tu-da zà-mì |
| BC | 215 | x šÁR × DIŠ é a si |
| BC | 216 | tùr-ná |
| BC | 217 | é šà-ta |
| BCF | 218 | INANNA men |
| BCF | 219 | ḫé-GAM + GAM |
| BF | 220 | ^d Ama-ušum-gal zà-mì |
| BCF | 221 | sil-dagal Kul-aba(UNUG) |
| BCF | 222 | men šu til |
| BCF | 223 | ud ^d KA.DI |
| BCF | 224 | ^d Nin-mes |
| BF | 225 | ban sa ud |
| BFN | 226 | LAK 489 za _x (LAK 798)-gìn |
| BF | 227 | ^d Nin-NAGAR zà-mì |

198. L₁ gud apin d[u; J gud x erím; B [EZE]N(?) N[E] x.

202. DINGIR only in B.

203. A apparently EZEN × GÍN; B EZEN × X.

212. C omits an.

221. C [UNUG.KU]L on separate line.

222. F ud for til.

223. Probably on same line with 224.

224. B um for mes; F 224 and 225 on same line.

227. zà-mì from B and C; B ^dNin-NAGAR, F ^dNin-SIG + é(= nigin?).

| | | |
|-----|-----|---|
| BC | 228 | giš-gi ki-du ₁₀ |
| BC | 229 | x nam ma |
| BC | 230 | ama ^a Li ₈ -si ₄ |
| BCJ | 231 | giš-gi ki-du ₁₀ |
| BCJ | 232 | x nam-ma |
| BCJ | 233 | zà-mì du ₁₁ -ga |
| BCJ | 234 | dingir gal-gal |
| BCJ | 235 | ama ^a Li ₈ -si ₄ zà-mì |

229. B probably ma omitted.

232. B ma omitted.

[Followed by colophons.]

Unplaced section, Source R, probably to be placed in the damaged section, lines 188–91:

- 1 é-an-ki
- 2 lugal gu si me
- 3 nun še sun(?) a lu

COMMENTARY

Lines 6–7. Perhaps the lines should be divided to read ^aEn-líl en / nu-nam-nir.

Lines 15–18. The hymn is to Ninunug, whose cult city is Kullaba. Since it is the sign LAK 32 which is used in writing Nanna(^ašeš.ki) and Uri(šeš.UNUG/AB^{kl}), it would seem that it has a value uri. Generally, however, it is the sign LAK 31 which is considered to be uri. See J. Bauer, *Altsumerische Wirtschaftstexte aus Lagasch* (“Studia Pohl,” IX [Rome, 1972]) p. 175 and references cited there. I assume that LAK 32 is also to be read šeš. Perhaps my assumption that the writing for Ur would include the sign to be read uri is erroneous, and LAK 31 is indeed uri, “emblem.” Note that a line identical to line 17 occurs in line 213.

Lines 19–29. The hymn refers to a temple in Kullaba into which the en-priest (of Inanna) enters, with some description of the temple of Kullaba and an invocation to Inanna. The sign in line 24 transliterated as x somewhat resembles LAK 493, but since there are unambiguous occurrences of mè in the Abū Šalābīkh texts, interpretation as mè is unlikely.

Lines 30–32. The reading of the divine name and the interpretation of his or her abode are unknown to me, but it may refer to Eridu.

Lines 33–34. This very short hymn is to Asal-lú-ḫi of Kuara, a city not far from Eridu (see Sjöberg, *TCS* III 25, lines 135–45). I know of no explanation for KAL in our text, but note that several manuscripts of the Temple Hymns have ^aAsal-lú-ḫi KAL.KAL; see *TCS* III 80. It is not to be read rib since the sign for rib is distinct from KAL in the archaic script.

Lines 35–36. The hymn is to the god Nanna and the city of Ur.

Lines 37–38. The hymn is probably to Utu, the sun god, paralleling Nanna, the moon god, in the preceding hymn, but note that a reading é-babbar is suggested by UD.UD in Source G.

Lines 39–40. The hymn is probably to Ningal of Ur.

Lines 41–43. The hymn is entirely obscure.

Lines 44–45. It is uncertain that the signs should be arranged to read NUN^{kl}, “Eridu,” but it is somewhat probable since ^aDam-gal-nun is the wife of Enki, god of Eridu.

Lines 46–51. The hymn may be to a form of Inanna (perhaps with a bow as part of her equipment, see line 48), addressed as ^aNin-um. INANNA.UNUG and INANNA.AB suggest the city of Zabalam. The comment on b/g interchange in the commentary to the Instructions of Shuruppak (rev. iv 13–14) below is perhaps relevant for the variant bù for gur₇-gur₇.

Lines 52–58. The three short sections are mainly obscure except that they deal in part with weaponry

(the bow in line 58, the quiver in line 53, and an unknown object in line 55, all qualified as *ud*, perhaps to be read *babbar*). For the three names preceding *zà-mì* (all with no divine determinatives), cf. ⁴AŠ-DU-UD, ⁴Am-gal-nun, and ⁴Ban-kù-lá in No. 86 ii 3–5 and dupl., No. 82 ii 21–iii 1; also see ⁴Ban-kù-lá in SF 1 x 22 (all god lists). It is possible that ⁴aš-DU-UD should be interpreted as AŠ-im_x-babbar. Note that line 52 and the first part of line 55 occur in No. 21, which should perhaps be considered a literary text; see also the List of Geographical Names, line 226.

Lines 59–64. The hymn is addressed to Ninbilulu, almost certainly to be connected with Enbilulu, god of irrigation, especially because of the explicit reference to the Tigris and Euphrates (probably UD.KIB.NUN^{kl}, “Sippar,” is an error in Source E). Ninbilulu also occurs in the god list, No. 83 vi 7.

Lines 65–69. The hymn is probably addressed to Nergal, if ⁴gIR.UNUG is the archaic equivalent of ⁴gIR.UNUG-gal. Cf. SF 1 vii 19 (god list). Kutha is not explicitly mentioned but is perhaps referred to as *dag-gal*, “great abode,” as a name for the underworld.

Lines 70–71. The hymn refers to Zababa of Kish as the butting ox (or perfect ox).

Lines 72–74. The hymn is addressed to Ašgi (*Ašširgi). For the proposed reading, see Biggs, in *JCS* XXIV (1971) 1–2. The epithet *nir-nun-gíd* also refers to Ašgi in SF 39 vii 17. For the writing of Adab as UD+NUN, see comments of Biggs, in *JCS* XX (1966) 83, n. 75, and Jacobsen, in *JCS* XXI (1967) 101.

Lines 75–77. The hymn is addressed to Nintu, goddess of birth, referring to Kesh as the brick of birth-giving (line 75). See also my comments in *ZA* LXI (1971) 196, n. 13.

Lines 78–79. In *JNES* XXXII 29, col. iv l. 8' I followed a suggestion of W. G. Lambert in reading *MES* as *pisan₂*, based on the syllabic writing *pi-sa-an-gu-nu-kum* in *Archiv für Keilschriftforschung* II (1924–25) 13, l. 15. A recent collation of the line, made at the request of Jerrold Cooper, indicates a partly erased sign and the sign *ME* instead of *PI*, indicating a reading *mes* for *MES*.

Lines 80–82. The hymn is obscure, but it probably refers to a deity from Uruk since it is preceded and followed by hymns to Uruk deities.

Lines 83–84. Ninsun is here, as in the epic text No. 327, referred to as *lamma*, “protective deity.”

Lines 85–86. The hymn is addressed to Lugalbanda, husband of Ninsun. Perhaps part of his epithet should be interpreted as *amar-kù*, “pure calf.”

Lines 87–88. The hymn is addressed to Iškur, the weather god, but it is not certain that *IM* should be taken as a writing for Karkara, his cult city (see J. Renger, *Archiv für Orientforschung* XXIII [1970] 73–78). I am inclined to take it as *šeg_x*, “rain,” and read *šeg_x ti še-gu*, “rain which makes the late barley grow(?),” comparing *šeg_x(IM.A.A) še-gu-nu*, “rain for the late barley,” in *TCS* III 36, l. 332.

Lines 89–91. The hymn is addressed to Nisaba and refers to her cult city, Eresh.

Lines 92–97. The hymn is addressed to ⁴Nin-ildumma(*NAGAR.GÍD*), whose cult city is not known to us. For the sequence of tools *gín*, *šum*, and *bulug*, see *MSL* IX 207–8. For the reading ⁴Nin-ildumma, see Falkenstein, in *ZA* LVII (1965) 62, l. 239 (The Curse on Agade). The sign in line 93 given in a convenient transliteration as *še + CUG* is not listed in *LAK*. It is not, in fact, made with *še*, which in Abū Šalābikh texts invariably has a horizontal wedge, but rather with wedges like those in *TU*. It seems here to be a word for a valuable metal or a stone.

Lines 98–99. The deity ⁴Ab-gíd-gíd (reading of the signs is uncertain) is also attested in No. 82 iii 4. For a suggested reading and interpretation of the sign *LAK* 159, see J. van Dijk, in *JCS* XIX (1965) 23–24.

Lines 100–101. The deity addressed is also attested in No. 82 ii 8 and SF 1 ix 8 (both god lists).

Lines 102–3. The hymn is addressed to Ašnan, goddess of grain.

Lines 104–7. The two sections are addressed to the principal gods of Umma, Ninur and Šara. The reading of the sign in line 106 represented by *x* is unknown to me, and it is not listed in *LAK*. It is not to be interpreted as *siLA₄* (for which see the section devoted to goats in No. 28). It occurs as a qualification of domestic animals in SF 81 (see the copy, col. i l. 1), represented in its other occurrences by the erroneous transliteration *é*. Some of the other occurrences in *Fara* II may likewise have been misread as *é*.

Lines 108–9. The hymn is addressed to Gatumdug of Lagash.

Lines 110–16. The hymn is to Nanše of Nina-Sirara, the nearest large city to Lagash. Note that *tag* occurs in UD.MÁ.NANŠE.TAG.KI, a logogram for Sirara. Probably *ab* in line 115 is a writing for “sea.”

Lines 117–19. The hymn is addressed to Ningirsu, god of Girsu (Tello). See Jacobsen, in *JCS* XXI 100, for a suggested interpretation of the name gir-su, which is perhaps relevant for é-gir nun (l. 118).

Lines 120–21. The hymn is addressed to Ningublaga of Kiabrig, a city probably in the Lagash area. I owe the reading Ningublaga (instead of Ningublam, as formerly read) to David I. Owen, of the University Museum, Philadelphia. See his review of S. Kang, *Sumerian Economic Texts from the Drehem Archive* (Urbana, 1972) to appear in *JNES*.

Lines 122–27. The entire hymn is obscure to me.

Lines 128–39. The hymn is in some way concerned with cattle but is mainly obscure. ÉŠ.BU.NUN is “lead rope,” probably to be read saman. See sa-ma-an é[š.SUD.NUN.TÚG.TU] = *šum-ma-[nu]* in Diri V 152 and [ÉŠ.SUD].NUN.GUD.TU = *šu-um-ma-nu-um* in Proto-Diri 571. See also the discussion of Å. Sjöberg, *Der Mondgott Nanna-Suen in der sumerischen Überlieferung* (Stockholm, 1960) pp. 20–21. This hymn is probably addressed to Ninazu of Enegi rather than to Ninazu of Eshnunna, not only because towns in the Diyala area are otherwise entirely absent in sources from Sumer during this period but because of the possibility that im in line 135 is to be read Enegi.

Lines 140–41. The hymn is addressed to ⁴Engur (or ⁴Nammu). For references, see J. van Dijk, in *Acta Orientalia* XXVIII (1964) 9, n. 13. The sign transliterated éš consists of three oblique wedges; the reading is not assured. The arrangement of the signs is uncertain. The occurrence of šu éš gi in No. 21 and its duplicate SF 23 iii 14 suggests that the signs belong together here as well. Note that the three signs qualify animals in SF 81.

Lines 145–46. Namnir as a divine name occurs in the personal name Amar-⁴Nam-nir in WF 67 col. v.

Lines 147–48. The hymn is obscure, but note that ⁴Gal-nun occurs frequently in the UD.GAL.NUN texts, often with UD-gal-nun as a variant.

Lines 149–51. Lamma-šaga is known among the gods of the Lagash region. See Falkenstein, *Die Inschriften Gudeas von Lagaš*, Part 1, Einleitung (“*Analecta Orientalia*” XXX [Rome, 1966]) p. 81.

Lines 152–56. Probably the signs in lines 152, 153, and 156 should be arranged to read BIL.GI.

Lines 157–59. It is uncertain whether or not the divine name should be taken as tiru(GAL.TE). The name perhaps occurs also in SF 1 iii 8 (god list). The sign transliterated x is URU with strokes inside resembling the strokes in GUG. The sign occurs in TŠŠ 302 rev. iii 7 and SF 57 xv 12 but is not listed in *LAK*.

Lines 160–62. The hymn is addressed to Ningirim (for the various pre-Sargonic orthographies, see Biggs, in *JCS* XX 80–81, n. 55). I know of no plausible interpretation for A.ḪA.MUŠ.DU in line 160. For line 161 see the discussion in *JCS* XX 80, n. 54. Besides the parallels cited there, the following can now be added: *MBI*, No. 1 “i” 5, “v” 14, and “vii” 5 (read from the photographs on Pls. 24 and 25) and also IAS 331. In a private communication, T. Jacobsen, using references given him by B. Landsberger, pointed out the correct sequence of signs for line 161, citing [ÍD.AN.MUŠ].DIN.TIR.BALAG = A-ra-aḫ-tum (Erimhuš VI 48), ÍD.AN.MUŠ(!).DIN.[TIR.BALAG] with gloss ir-ḫa-an (*KAR*, No. 284 i 4–5), and ÍD.AN.MUŠ.DIN.TIR.BALAG = Pu-rat-tum (*CT* XIX, Pl. 25, K.14042(!):6+K.14329 [unpublished]), and that the commentary (*2R*, Pl. 35, No. 1 ii 6) should be read ÍD ir(!)-ḫa-an = Pu-rat-tú. It is to be noted that the archaic writing includes the syllables ir-ḫa-an, probably as a pronunciation indicator for the archaic Sumerian orthography. According to this evidence, Murum, the cult center of Ningirim, was probably on the Araḫtu, a main branch of the Euphrates, at least in the middle of the third millennium B.C.

Lines 163–64. For the sign transliterated as x, see the comments on lines 104–7 above. The deity addressed is not Ninlil, since her name is invariably written with the KID sign in pre-Sargonic texts (see Biggs, in *JCS* XX 84, n. 85, but see also the note to KID, s.v. ⁴Nin-KID, in the List of Signs and Terms Discussed). To avoid possible confusion, I have used é in the transliteration.

Lines 165–66. For the problem of reading the name of the deity ⁴Nin-mar, see Sollberger, in *ZA* L (1952) 10, n. 1, Sjöberg, *TCS* III 109, and Biggs, in *JCS* XX 81, n. 56. Note the writing ⁴Nin-mar-gi₄ in No. 83 iv 4, which perhaps is a writing for the name of this deity. Her cult city was Guabba (usually written Gú-ab-ba^{kl}).

Lines 167–69. The entire hymn is obscure.

Lines 170–71. The deity ⁴Nin-kas-si-din (perhaps read rather ⁴Nin-kas-din-si) occurs a number of

times in Abū Šalābikh literary texts. It is tempting to suggest a connection with ^aNin-ka-si (SF 5 v 7 [god list]). See also Civil, "A Hymn to the Beer Goddess and a Drinking Song," *Studies Presented to A. Leo Oppenheim* (Chicago, 1964) pp. 67–89.

Lines 172–74. The hymn is addressed to Inanna-of(?)-the-Mountain(?), not known to me elsewhere.

Lines 175–76. Nin-zadim is the patron deity of lapidaries. See *CAD*, s.v. *zadimmu*.

Lines 177–79. Ninsar (I follow the advice of W. G. Lambert in reading Nin-sar rather than Nin-mú) is here identified as the patron deity of one of the crafts. Cf. ^aNin-sar : GÍR. [LÁ] É-kur-ra-ke₄ in *CT* XXIV, Pl. 10, l. 16 (god list). Perhaps NAGAR should here be read bulug_x.

Lines 180–81. The hymn is addressed to ^aSùd, goddess of Shuruppak.

Lines 182–83. The deity ^aNin-PISAN × MUŠ is not known to me except in this text and No. 82 iv 16 and SF 1 iii 10 (god lists).

Lines 184–85. The deity ^aNin-á(or: da)-NE is unknown to me elsewhere.

Lines 186–87. ^aNin-in is known also in SF 1 iv 18 (god list).

Lines 188–92. The text in these lines cannot be reconstructed confidently. See p. 53 for lines which probably belong here.

Lines 193–95. Perhaps line 194 refers to the good en-priest, also mentioned in the Kesh Temple Hymn (Gragg, in *TCS* III 174, l. 108). The deity is listed in No. 82 vi 9, just after the deity named in the following hymn. The reading of the name is uncertain.

Lines 196–97. The deity is attested in No. 82 vi 8 (god list). The reading of the sign LAK 613 is uncertain here. It has a value ug₅, as pointed out by F. R. Kraus in *JCS* III (1949) 70, but it quite likely has others as well. Several occurrences in *NTSS* and in this volume are cited in the description of *NTSS* 168, and there are a number of other occurrences in this volume. I have arbitrarily transliterated it as EZEN × AN, even though it is uncertain whether LAK 611 or 617 is ezen (for the sake of convenience both, when occurring with other signs inscribed within them, are transliterated EZEN in this volume). The word bàd, "wall," is written with the sign LAK 619 (see passages cited by Gelb in *MAD* No. 3, pp. 106–7, the name A-lum-BÀD in colophons in this volume, and occurrences in the List of Geographical Names), and consequently a reading bàd for LAK 613 is excluded.

Lines 198–99. For Kisig as the reading for the city name written EZEN × SIG₇^{kl}, see *MSL* II 88, l. 781, and p. 97, with correction in *MSL* III 214. The deity ^aNu-NUNUZ-du₁₀ also occurs in No. 47 rev. ii 3 and duplicates and also in No. 83 iv 11 and SF 1 viii 26 (god lists).

Lines 200–202. The name of the deity ^aLugal-kud-da, also attested in No. 83 ii 9 (god list), is written ^aLugal-kud in SF 1 rev. iv 27.

Lines 203–4. The deity ^aDam-mi is unknown elsewhere but is probably the same as ^aNin-dam-mi in No. 83 obv. ii 11 (god list), separated from ^aLugal-kud-da by ^aA-nir.

Lines 205–6. The hymn is entirely obscure except for a possible reference to a water bag (KUŠ.A.EDIN).

Lines 207–8. There is a deity ^aNin-al in SF 1 vi 20 (god list), perhaps to be connected with ^aNin-al-šul. It seems doubtful that AL should be read as maḥ_x.

Lines 209–11. ^aAmar-engur-na (the sequence of signs is uncertain) is unknown to me elsewhere.

Lines 212–14. The hymn is probably not to Nin-tu (usually called simply Tu in archaic texts, including line 77 above, where her identity is certain). A line identical to line 213 occurs as line 17.

Lines 215–20. The hymn perhaps refers to a temple or storehouse filled with . . . , a pen where animals lie down, and a building from(?) which Inanna takes GAM + GAM is a conventional transliteration of the sign in line 219 whose reading is unknown. Some examples are cited in *Orientalia* n. s. XXXVI 65, n. 4. The cult city of Amašumgal is Uruk.

Lines 221–27. The hymn is connected with Kullaba, but in spite of several textual variants, it is obscure. Note the mention of Ištaran (^aKA.DI), if I have arranged the signs in the correct sequence. The reading and meaning of LAK 489 are unknown, but note that here it appears to be an object made by a craftsman. See the discussion in *MSL* XII 11–12. If the interpretation of the first half of line 221 as sil-dagal, "wide street," is correct, it would show that the value dagal belongs to the archaic sign ENGUR and not AMA.

Lines 228–35. The sign in lines 229 and 232 transliterated as x is formed like BAR with horizontal wedges crossing the vertical. It is not yet known except in Abū Šalābikh texts, e.g., No. 82 ii 16 and No. 83 vi 11 (god lists). Note that lines 233–34 parallel lines 13–14 of the prologue.

THE INSTRUCTIONS OF SHURUPPAK

In addition to the Abū Ṣalābīkh version of the Instructions of Shuruppak (published here as No. 256), there is an Early Dynastic version from Adab.³ For paleographical comparisons and to show the joins and relative positions of the preserved fragments, a photo of the Adab tablet is given here (Fig. 30).⁴ The original size of the Adab tablet cannot be ascertained; a partly preserved portion of the edge shows that its thickness exceeded 3.3 cm.

There is no published critical edition available for the Old Babylonian version, but I have had the benefit of manuscripts of Bendt Alster (1971) and M. Civil (1966) which both have kindly allowed me to use. Alster's reconstruction of the composition has 270 lines and Civil's, slightly more complete, has 273. In both reconstructions there are several poorly preserved passages, especially in the first quarter and toward the end of the composition. The transliteration of the Abū Ṣalābīkh version with the Adab and Old Babylonian parallels is principally the work of Civil. Some of the line numbers used for the Old Babylonian version may need to be changed slightly when some of the damaged parts are recovered.

Although, as a rule, sections of the several lines of the Early Dynastic versions agree with the Old Babylonian version, they also differ from each other as well as from the Old Babylonian version in the order of their sections. Furthermore, many lines in the Early Dynastic versions seem not to be represented in the Old Babylonian version.

The following passages give further illustrations of the general characteristics of the Early Dynastic writing system pointed out by Civil.⁵ Included are examples of logographic substitutions (e.g., A in the archaic version for OB fd in rev. ii 10 and iv 2), truncated lines (v 11), and a particular type of abbreviation in lines which have the same verbal root twice (rev. iii 13-14). The Abū Ṣalābīkh version gives the root only once.

The lines given in transliteration are intended on the one hand to give a general view of the relationship among the versions and on the other hand to clarify some of the scribal practices in Early Dynastic texts.⁶ No translations are given, nor are possible differences in meaning between the different versions pointed out since a separate lengthy study would be required. Nevertheless, it should be noted that the u₄-ri-(a) introductory formula found in the OB version and so frequent in other Early Dynastic texts is not included in the Abū Ṣalābīkh version (the corresponding part of the Adab version is not preserved).

TRANSLITERATION

- i 1-2 geštu₂ inim-zu / [ka]lam ti-la
 Ad [... z]u-am₆ / [kalam]-ma [t]i-la-am₆
 OB 4 (u₄-ba) gestu₂-tuku KA-galam inim-zu-a kalam-ma til-la-àm
- i 3-5 (traces) / [GIŠ. PĪ]. TÚG inim-zu / kalam ti-la
 Ad [Šurupp]ak^{kl} [Ú]R.AŠ / [GIŠ. PĪ]. TÚG [tuk]u(?) inim-zu-am₆ (or: ka [galam(?)
 inim]-zu-am₆) / [kalam-m]a [ti-la-am₆]
 OB 5 Šuruppak^{kl}-e gestu₂-tuku KA-galam(?) inim-zu-a kalam-ma til-la-àm

3. See M. Civil, in *RA* LX (1966) 1-5.

4. The top fragment in the photo does not join the other fragments, although the columns are correctly arranged. Only three of the fragments published as *OIP* XIV, No. 55 can be joined or placed in relation to the main piece (*OIP* XIV, No. 56). Of the remaining fragments, some certainly belong to the reverse toward the end of the composition. The close relationship in handwriting between this inscription

and the archaic Enlil and Ninursag myth (*MBI*, No. 1) should be noted.

5. In *RA* LX 12-16. See also Civil, "The Sumerian Writing System: Some Problems," *Orientalia* n.s. XLII (1973) 21-34.

6. Not all lines have been transliterated. Variants are given for the Old Babylonian version only when they are useful for the understanding of the Early Dynastic orthography.



FIG. 30.—INSTRUCTIONS OF SHURUPPAK, FROM ADAB (A645 + 649).
APPROXIMATELY ACTUAL SIZE

- i 6 Šuruppak dumu [n]a-na mu-de₅
i 7-8 dumu-mu na ga-de₅ / GIŠ. PÍ. [TÚG] ḫé-[ma]-ak
Ad [...] / [...] ḫé-[m]a-ak
OB 10 dumu-mu na ga-de₅ (...) gizzal ḫé-im-ši-ak
- ii 3 geme₂ kar-ak na-šám KA ù-SAR-kam₄
OB 151 kar-kid na-an-šám-šám-an KA u₄-SAR-ra-kam
- ii 4 gán-a pú na-ú[s](?) x 'a' u[n] ra-ḫul¹(?)
OB 17 gán-[za sa]g(?) pú na-an-dù a un-e ša-ri-ib-ḫul-ḫul
- ii 7-8 'šu-dù¹ na-túm lú / šè-ba-dab
OB 19 šu-[dù-a na]-mu-un-túm lú-bi še-ba-e-dab-bé
- ii 9 šà šu-BAD na-ak x x
OB 20 za-e [šu]-dù-a nam-mu-e-ak-e
- iii 1 du₇ x ku₅-kúr [túm]-ma
OB 31b in-nu-uš ku₅-kúr [...]x-ib-túm
- iii 2 NI-LAK 134 bar-bar-ta túm-ma
OB 31a du₁₄-dè bar-bar-ta túm-túm-[ma]
- iii 3 Šuruppak dumu na-na mu-de₅
Ad ÚR. AŠ dumu-ni-ra / na-na mu-de₅-de₅
- iii 4 níg-na mu-dug₄-dug₄ me-zu na-munšu(b)
Ad níg-nám dug₄-dug₄ ní-z[u] 'AN. AN-munšu(b)¹
OB 32 níg-nam mu-ḫug₄¹(?)-[dug₄] ní-zu nam-mu-úš-e
- iii 5 nu-zuḫ / ušum na-nam UL. TUŠ geme₂ na-nam
Ad nu-zuḫ / [pi]rig na-nam ù / KU geme₂ na-nám
OB 38 ní-zuḫ pirig na-na-àm UL. KU sag na-nam
- iii 6 é-na [...]
Ad é-na[m] m[u...]
OB 33 é na-ám-x-e-en...
- iii 7 [sa]-ḫgaz¹ na-ak x gíd [x] x
OB 35 (dumu-mu) sa-gaz nam-mu-ù-ḫak¹-e
- iv 2 ka-sig [m]aḫ_x(AL)
OB 38b ka-sig(var.: -si)-ga ma[ḫ-(àm)]
- iv 4 KA na-tar [x] x gar-ra
OB 40 KA nam-tar-tar-re inim-zu gar-ra-àm
- iv 5 L[UL x] x x x su sal-sal
Ad [LU]L [x] gur₅-gur₅ / sag sal-sal-[a]m₆
OB 41 LUL na[m]-ḫgur₅-gur₅¹ sag gú(vars.: ku, kù) s[al-sa]l(?) -àm
- v 7 KA na-kú
OB 44b KA-a nam-mu-da-kú-e
- v 8 'šu¹ [...] x DU
OB 45 šu-zu bad-àm na-di-ni-ib-su-su-([a]m)

- v 9 [an]še(?) ur₅ gud šám
 OB 46 [an]še(?) ur₅-re gud ša-b[a-ri]-ib-su-su udu ša-ba-ri-ib-s[u-s]u
- v 10 ù nu-gar na-dug₄
 OB 47 ù nu-gar-ra na-a[b-b]é-e
- v 11 [e]gir GIŠ.búr
 OB 41 egir-bi-(šè) GIŠ.búr-gim [(...)] igi-me ši-íb-lá-e
- v 12 ú nu-ḥul udu ^śság na-dug₄(!) (text: SAG)
 OB 45 ú nu-kin-gi-šè udu-zu ṽság¹ nam-me
- vi 2-3 kaskal gi₆ na / šà x ḥul
 Ad kaskal g[i₆ x] D[U x x]
 OB 52 kaskal gi₆ na(var.: nu)-DU šà-bi šag₅ ḥul-a
- vi 4-5 edin na-šám / u₅ šè-šám
 Ad [...] anše-edin / AN.AN-šám [...]
 OB 53 anše-edin-na na-ab-šám-e
- vi 6-7 geme₂-zu_x(AZU) mī giš na-e / zú-ur₅ šè-mu-x
 OB 54 geme₂-zu-úr giš na-an-dù zu-úr šu-m[u]-ri-in-sa₄
- vi 10-11 dumu-engar níg na-ra / E + E-zu_x(AZU) šè-ra
 OB 158 [dumu]-engar-ra níg nam-mu-ra-ra-an e-pa₅-zu ši-im-ra
- vi 12-13 ḤAR-tu na-šám / ú libiš gig
 OB 152 ṽHAR¹-tu na-an-šám-šám-(an) ú libiš gig-ga-àm
- rev. ii 9 giš-gi [x x] šà-bi sig [x]
 OB 93 giš-gi gi-ú na-zi(?) šà-bi eme_x(KA)-sig-ga-àm
- rev. ii 10 é-gal A-maḥ šà-bi gud ṽdu₇¹
 OB 94 é-gal íd-maḥ-àm šà-bi gud du₇-du₇-àm
- rev. ii 11 níg-lú ga-sì B[U] s[l](?)
 OB 97 níg-lú-ù-ka ga-ra-ab-sì-ga KU-nu-a
- rev. ii 12 sum-da B₁ x [x]
 OB 98 sum-mu-da B₁ an-bad-rá-àm
- rev. ii 13 níg-ú-rum níg x x [(x)]
 OB 101 níg-ú-rum níg-á-sì-ga-a-da
- rev. iii 7-8 lú níg-tuku lú níg nu-tuku / áš-gig-šè gar
 OB 182 lú níg-tuku lú níg nu-tuku gig-šè im-gar
- rev. iii 9 níg-tuku sag me-te-gál
- rev. iii 10 níg nu-tuku sag gi è
- rev. iii 11 dam tuku á-šè du₇
 OB 181 lú dam tuku á šu im-du₇-du₇
- rev. iii 12 dam nu-tuk šér-dib DU
 OB 182 dam nu-un-tuk še-er-tab-ba mu-un-ná
- rev. iii 13 [l]ú zi lú TAR šè-da-
 OB 184 lú zi-zi-i-dè lú ša-ba-da-an-zi-zi-i

- rev. iii 14 é gul é šè-da-
OB 183 é gul-gul-lu-dè é ša-ba-da-an-gul-e
- rev. iv 2 hul(!)(text: UR)-da A zág(PA) su
OB 196 hul-da íd-da zàg(šID) h́é-en-da-su
- rev. iv 3 edin KUŠ.A. EDIN dar
OB 197 an-edin-na KUŠ.A. EDIN. LÁ h́é-en-da-dar
- rev. iv 4 šà ki-ág níg é dù-dù
OB 198 šà ki-ág níg é dù-dù-ù-dam
- rev. iv 5 šà hu(!)(text: RI)-gig níg é gul-gul
OB 199 šà hul-gig níg é gul-gul-lu-dam
- rev. iv 6-7 nir-gál níg-du₁₀-du₁₀ / gaba-gál me nam-nun-kam₄
OB 200 nir-gál níg-tuku-tuku(var.: [d]u₈-du₈) gaba-gál me nam-nun-na-ka[m]
- rev. iv 8 gaba-gál gú h́é-gál
OB 201 nir-gál-ra gú h́é-en-dè-ni-gál
- rev. iv 9 á-tuku KA-zu_x h́é-lá
OB 202 á-tuku ní-zu h́é-en-dè-ši-lá
- rev. iv 10 lú hul-gál ḥ́é¹-x (or: lú hul-x ḥ́é¹-gál)
OB 203 (dumu-mu) lú-hul-gál-ra h́é-en-dè-ši-gál-le
- rev. iv 11-12 munus-bar-[š]u(?) -gál šè / [x x] šè-DU
OB 215 munus-bar-šu-gál-e kisal dab-bé-šè mu-un-DU
- rev. iv 13-14 [KAš kur]un₄ nag-nag / gur[u₇] šè-LAGAB. LAGAB
OB 216 KAš kurun₄ nag-nag-e buru_x(EBUR) im-su-su-su
- rev. iv 15-16 mu-mu si-ga x / lú šè n[am (x)]
OB 165 mu-mu-a si-ga lú-(ù)-ra im-x-x-e
- rev. vi 2 é šà é uru šà šè-dù-dù
OB 257 é uru₂-bar-ra-ke₄ uru šà-ga ši-dù-dù-e
- rev. vi 4 gán-a KU-šè gál . . .
OB 258 (dumu-mu) é-e KU-bi-šè gál-la
- rev. vii 4' . . . kadra(NÍG. ḥ́ŠÁ¹. A) / [i]nim AN. ḥ́AN¹. [. . .]
OB 264 kadra inim-inim-ma mul [. . .] (last line before the concluding formula)

COMMENTARY

Column i

Lines 1-2. The Ur sources seem to have ka-pirig instead of ka-galam(?).

Column ii

Line 3. Note that geme₂-kar-ak is the archaic equivalent of kar-kid. See also geme₂-SAL. Uš-kar-ak in *MSL* XII 19, l. 173.

Line 4. Cf. *ina rē[š eqli]ka būrta [la] teḥerru*, “do not dig a well in your field,” J. Nougayrol *et al.*, *Nouveaux textes accadiens, hourrites, et ugaritiques des archives et bibliothèques privées d’Ugarit* (“Ugaritica” V [Paris, 1968]) p. 279, col. iii, l. 5.

Line 9. If šà corresponds to za-(e), one should note š for z in šà-ḥi-li^{sar} (SF 58 v 13 and duplicates), corresponding to later zà-ḥi-li^{sar}.

Column iii

Line 4. The proposal of Civil, in *RA LIV* (1960) 71, note to line 127 and n. 4 that the sign LAK 672 should be read munšu(b) or sub_x/šub_x is certainly correct. Besides the passage here, see giš—dug₄ ne—šub_x in Nos. 283 and 231. See also J. van Dijk, in *Acta Orientalia XXVIII* 38, n. 106 and Falkenstein, in *ZA LV* (1963) 17, n. 31.

Column v

Line 12. Note that sá occurs as a phonetic indicator with 𒍪É in the reading sag_x, just as later the reading sag is given for PA + 𒍪É, i.e., it appears that PA (i.e., sàg) was intended as a phonetic indicator for 𒍪É in the reading sag. Probably É on the edge of the tablet does not belong with this line.

Reverse, column ii

Line 10. A in the archaic text is perhaps to be considered id_x in view of the Old Babylonian íd; see also rev. iv 2.

Column iii

Line 13. Note that the archaic version does not repeat the verbal root zi in the second half of the line but has only šé-da-.

Line 14. It is uncertain whether or not there is room for gul in the second half of the line.

Column iv

Lines 13–14. Note that gur(u)₇ in the archaic version corresponds to buru_x (EBUR, i.e., EN × GÁN-tenú). Note kur as a variant to buru_x in the Bird-Fish Contest, line 101. Further examples of g/b interchange are given by Civil in his article "From Enki's Headaches to Phonology," *JNES XXXII* (1973) 59–61. Note that the archaic equivalent of su-su-su is LAGAB.LAGAB, of unknown reading. LAGAB.LAGAB is a frequent combination in the UD.GAL.NUN texts, but the interpretation is unknown to me. Some occurrences of buru_x with su-su are cited in *CAD*, s.v. *ebūru*.

THE NAMES AND PROFESSIONS LIST

The Names and Professions List is so far unique to Tell Abū Šalābīkh, unlike the simple list of professions (Nos. 54–60 in this volume), which has duplicates from Gasur and Kish. Although SF 28 and 29 are, at least in part, lists of personal names and professions, names of professions seem to dominate. Even though many of the fragments upon which this edition is based are very small, the large pieces preserved make it apparent that at least five or six copies of the composition are represented.

The origin and purpose of this text are by no means certain. It is likely that its composition is relatively close to the time the tablets were copied since several of the personal names included are Semitic and several others probably Semitic. It may well have been composed at Tell Abū Šalābīkh. Whatever the origin of the text may have been (census of property owners, list of persons on the city administrative staff, or the like), it apparently originated earlier than the generation of scribes who copied the tablets. None of the scribes are included in the text itself, for it was already a part of the local scribal repertory.

The principle of organization of the text is unclear, although it begins with names of high administrative officials. Some of the personal names (e.g., A-ul₄(GÍR-gunú)-gal) occur several times, but each time with the name of a different occupation. Several occupations are represented several times as well. Several individuals are further identified by the name of what seems likely to be their home town (e.g., Adab, Sippar), and if this interpretation is correct, it may indicate the mobility of artisans and craftsmen.

A detailed study of this composition cannot be given here. Nevertheless, it has seemed useful to give at least a preliminary edition. There is considerable variation among the various manuscripts in the distribution of lines. My transliteration in general represents the "long version," in which separate lines are normally used for the personal name and the name of the profession.

THE NAMES AND PROFESSIONS LIST

63

Even though this helps considerably, there are many lines which remain enigmatic. Many of the names occur in texts from Fara and most of the others belong to name types known from Fara and other pre-Sargonic sources.

SOURCES

| | | | |
|-----------------|-----------------|-----------------|-----------------|
| A No. 62 | G No. 78 | L No. 66 | Q No. 72 |
| B No. 61 | H No. 63 | M No. 77 | R No. 70 |
| C No. 74 | I No. 80 | N No. 68 | S No. 71 |
| D No. 75 | J No. 65 | O No. 79 | T No. 67 |
| E No. 64 | K No. 69 | P No. 81 | V No. 76 |
| F No. 73 | | | |

TRANSLITERATION

| | | |
|-------------|----|---------------------------------------|
| C | 1 | L[ugal-x]-nun |
| ACDH | 2 | [x m]e(?) ud |
| ACDH | 3 | PA.TE.SI |
| ACD | 4 | ši RI erim |
| ACD | 5 | sanga |
| ACD | 6 | im ib |
| ACF | 7 | sag-dùn |
| A | 8 | sal(?) ul ₄ (GÍR-gunú)-gal |
| A | 9 | dub-sar |
| A | 10 | [x] lú [(x)] ga nir |
| A | 11 | [x anš]e(?) |
| G | 12 | [x] sukkal |
| | 13 | missing |
| F | 14 | [x] x [gi]š(?) an |
| F | 15 | [e]n kal[am] |
| F | 16 | [m]es an |
| FGJ | 17 | [ga]l(?) sukkal |
| FJ | 18 | [b]an-mes-kalam |
| FIJ | 19 | x sag |
| F | 20 | [x ka]lam |
| F | 21 | [x x g]in |
| | 22 | missing |
| DH | 23 | Ur- ^d En-líl |
| D | 24 | nimgir |
| D | 25 | La-la |
| ADE | 26 | gal-nimgir |
| ACDE | 27 | sal-erim-kalam |
| ACDE | 28 | Níg-gu-sur |
| ACDE | 29 | gu-gu |
| ACE | 30 | SAḪAR |
| ACE | 31 | UD.KIB.NUN ^{kt} |
| ACEF | 32 | Lugal-šu-du ₇ |

12. Placement uncertain.
28. C adds nun.

30. With line 29 in C.
31. With line 29 in C; *ki* only in E.

| | | |
|-------|----|--|
| ACF | 33 | dím |
| ACFG | 34 | ušum-edin |
| CFG | 35 | ʾšU.QA ¹ .DU ₈ |
| CG | 36 | az za _x (LAK 798) KA × šU |
| BCG | 37 | kinda |
| CG | 38 | A-geštin |
| BC | 39 | SAḤAR sipa |
| BCF | 40 | A-ul ₄ (GÍR-gunú)-gal |
| CFI | 41 | SAḤAR pa áb |
| BCFI | 42 | pab kur-gal |
| BCFI | 43 | kurušda |
| BCFI | 44 | an-ki |
| BCF | 45 | ur |
| BCDF | 46 | Amar- ^d šÁR × DIš-gi ₄ |
| CDF | 47 | gal ₈ -lá |
| CF | 48 | [x] ni lul |
| EFS | 49 | ga ri |
| AEFS | 50 | nu-banda ₃ -KAL |
| AEFS | 51 | ban-mes-kalam |
| AEF | 52 | PA.TE.SI-tur |
| AEFG | 53 | Ur-sag-gàr |
| AEFG | 54 | giš-ti-du ₁₀ |
| AFGJL | 55 | A-ul ₄ (GÍR-gunú)-gal |
| BFGJL | 56 | dumu-zi |
| FJ | 57 | ud-kalam |
| BFJ | 58 | kaskal-erfm |
| FJ | 59 | i-bal-BU |
| FJ | 60 | kinda |
| F | 61 | geštin-ki-a |
| B | 62 | [x d]a-edin |
| BFT | 63 | gu-é-nun |
| BFT | 64 | gal-ukkin |
| BFT | 65 | bar-ki |
| BCFT | 66 | URU × DU ₁₀ UD. ùḤ. KI |
| BF | 67 | KUD-fb |
| BCF | 68 | gú-a |
| BCFK | 69 | an kiš ki gal |
| BCFK | 70 | dalla |
| BCF | 71 | ši RI ba ni GAL.NI |

33. With line 32 in C.

35. With line 34 in C.

37. With line 36 in C.

39. sipa written over erased ki in B; with line 38 in C.

41. With line 40 in C; pa only in C.

43. With line 42 in C.

45. With line 44 in C; gal-KA × šU for ur in F.

47. tje [lu] [x]-nun in C, probably covering lines 47 and 48.

50. With line 49 in S.

54. No text preserved completely.

56. Combining of texts uncertain; G dumu an [x] or dumu-z[i](!); with line 55 in J.

58. Undeciphered sign in B; with line 57 in J.

59. su for BU in J.

60. With line 59 in J.

63. búr for gu in F.

65. With line 64 in B,T.

66. ùḤ. KI in F, UD. ùḤ(!). KI(?) in T; KI not preserved in other sources.

67. F DÙ for KUD.

68. With line 67 in B, C.

69. Apparently preceded by a line ending in k]i in K.

71. Apparently ši ḤU for ši RI (or ar) in B.

THE NAMES AND PROFESSIONS LIST

| | | |
|--------------|-----|--|
| BCF | 72 | LAM × KUR gi ₄ -me-ru |
| BCF | 73 | sanga mu |
| CF | 74 | an kiš x |
| CM | 75 | u[d] x šè |
| CFM | 76 | [ba]n-mes-kalam |
| ACFLM | 77 | a-zu _x (AZU) |
| ACEFL | 78 | da IGI + LAK 527 |
| ACEFL | 79 | sag-sum |
| CFL | 80 | ban-mes-kalam |
| CFLN | 81 | lú anše |
| BCFN | 82 | É-nu-si |
| BCF | 83 | šubur |
| BF | 84 | mes-pa- ^r è ¹ (?) |
| F | 85 | [x] in x |
| BFJ | 86 | nu ma tar ki |
| BFJK | 87 | á-na |
| BFK | 88 | a LAK 527 ki |
| BFJK | 89 | Ur- ^a Za-ba ₄ -ba ₄ |
| BFK | 90 | UD.NUN ^{kl} |
| FJK | 91 | ušum-edin |
| FJK | 92 | lú-du _g |
| FJ | 93 | Lu-lu Unug ^{kl} |
| BJ | 94 | lum nu za ki [(x)] |
| F | 95 | ka [x] |
| BC | 96 | dar bal lú-x |
| BC | 97 | il-x(IGI + LAK 527) |
| BC | 98 | šu-tar |
| BC | 99 | ba-na |
| BCM | 100 | lú-gú-si |
| BCFM | 101 | maš(?) -na |
| CFLM | 102 | má-[l]aḥ ₄ |
| CFL | 103 | im- ^{fb} |
| FL | 104 | kù-gál |
| FL | 105 | lugal-du ₁₀ |
| FLK | 106 | lú x [x] |
| BCK | 107 | šeg ₉ -maš maš-dà |
| BCK | 108 | Ur-URU × ^{TU} _{TU} |
| BCK | 109 | bur-gul |
| BCK | 110 | Ur-LAK 647 |
| BCK | 111 | lú-geštin |

73. With line 72 in C.

77. With line 76 in C.

79. With line 78 in C; sum-sum for sum in L.

86. F pa for tar.

88. With line 87 in B, F, [JJ].

89. K has za_x(LAK 798) for za.

91. F adds lú.

92. With line 91 in F, J.

93. J has lu for lu-lu, though there is perhaps room for another lu.

94. Apparently omitted in F or replaced by line 95.

95. Combining of sources in lines 93-95 is uncertain.

97. Perhaps ^rerim¹-il in C.

98. With line 97 in C.

99. With line 98 in B.

100. With line 99 in C; traces uncertain in F.

101. Text from C; B x-na; M ba-n[a].

102. Combining of sources not certain; with 101 in C.

103. B apparently x te.

105. Perhaps room for gal in F.

107. B clearly [še]g₉-maš (not -bar); C omits maš or bar; K omits maš-dà.

111. With line 110 in C.

| | | |
|------|-----|--|
| BCFK | 112 | ud-è-mu |
| BCFK | 113 | Íb- ^d Ma-ma |
| BCFK | 114 | ki-gul lú-dim |
| BCFK | 115 | A-lum |
| BC | 116 | lú-usan ₃ |
| B | 117 | an šÁR × DÍŠ [x] |
| BJ | 118 | I-[t]i-ì-lum |
| BJ | 119 | x nun [kas]kal ur-sag |
| BJ | 120 | gi zi ab |
| BFJ | 121 | Ur-ba ₄ -a-si |
| BJ | 122 | lú-éš-gàr |
| B | 123 | da íb |
| BF | 124 | lú-kaš ₄ |
| BF | 125 | Ba-zi |
| BFK | 126 | BÀD |
| BCFK | 127 | Ba-lul-lul |
| CK | 128 | uš × x |
| BCFK | 129 | gud am kalam |
| BFK | 130 | SAḪAR bu kár |
| BCFK | 131 | mes-sar |
| BCK | 132 | gal-sukkal é x |
| BCFK | 133 | ^d MI. MUŠEN-me-ru |
| BCK | 134 | an-bíl-du ₁₀ |
| BCK | 135 | e-gi PA. KAŠ ₄ |
| BC | 136 | ù-sar |
| BC | 137 | ù gal-gal |
| BC | 138 | šita _x (LAK 503) ni a |
| BC | 139 | i-bí-la |
| BC | 140 | sanga nin |
| B | 141 | Nin-kalam-du ₁₀ |
| B | 142 | dub nin-sar |
| B | 143 | x x ṽsig ₇ ¹ (?) ^{TU} _{TU} |
| B | 144 | mi na lum |
| BJ | 145 | dub bu kár |
| BJK | 146 | aš-dar bal |
| BJK | 147 | SAḪAR-é-ud |
| BJK | 148 | igi-lam-lam |
| BK | 149 | lú-sag |
| BK | 150 | Ur-sag |
| BK | 151 | nagar-gal |
| BK | 152 | an-ta |
| K | 153 | simug-gal |

113. íb-ma in B, C, [F].

114. ki-gul with line 113 in C; lú-dim omitted.

118. Not certain that the sources are correctly combined.

121. J Ur-x-ba-a-si.

126. With line 125 in B.

128. Text from K; C s[ag (x)]; traces in F.

129. With 128 in F.

131. All copies mes, not dub.

132. C omits gal.

135. C omits e-gi; with line 134 in C.

137. Text from B; C ṽ' [x x] x [g]i(?).

138. Text from C; B šita_x [x] a KA × šu íb.

139. Text from C; B [m]e-li.

146. J omits aš, adds é.

147. K adds an(?).

149. With line 148 in B.

152. Text from K; B [x t]e.

153. Text from K; B illegible.

| | | |
|-------------|-----|--|
| BK | 154 | me(?)-nu-še(?) |
| BK | 155 | ašgab-gal |
| B | 156 | amar-an-si lú-kuš |
| B | 157 | sig na sar |
| BC | 158 | šu-i |
| BC | 159 | lugal-LAK 586 |
| BC | 160 | IGI + DUB |
| BC | 161 | ukkin-kalam-du ₁₀ |
| BC | 162 | x sar é x |
| B | 163 | [x] an d[a x] |
| B | 164 | ga x [x] |
| C | 165 | a-lum-lum šeš |
| BCK | 166 | maš gan |
| BCK | 167 | lugal-du ₁₀ garaš |
| BCK | 168 | Ad- ^{TU} |
| BK | 169 | lú-dub |
| BK | 170 | me-ki-ša |
| BK | 171 | LÚ × šè il |
| BK | 172 | a-ur ₄ -ki |
| BK | 173 | amar an ad-KID |
| BKO | 174 | ba-na |
| BO | 175 | nu-banda ₃ gal ₅ -lá |
| BKOR | 176 | Ur-sag-gàr |
| BOR | 177 | nu-banda ₃ -sukkal |
| BOR | 178 | im é [m]ar |
| BOR | 179 | bur-gul |
| B | 180 | [g]iš an tuk |
| B | 181 | ganun ḥab |
| B | 182 | az KA × šU |
| B | 183 | sikil |
| B | 184 | bíl-an-s[i](?) |
| BK | 185 | kur dūr |
| BK | 186 | gal-zu |
| BK | 187 | KA × šU KA × A |
| BK | 188 | A-ul ₄ (GÍR-gunú)-gal |
| BK | 189 | LAK 183 |
| BK | 190 | il-x(IGI + LAK 527) |
| BK | 191 | zi-gi ₄ -ni |
| BCK | 192 | na sum |
| BCK | 193 | URU × A ^{K1} |
| BCK | 194 | ban-din |
| BC | 195 | mùš-din |

154. **B** maš nu x.160. With line 159 in **C**.162. Text from **B**; **C** adds ma to other traces.

163–65. Sources not reconciled and proper sequence of lines is uncertain.

165. **K** [x t]i sag.166. **C** am(?) for maš.170. Vertical wedge inside ša in **K**.175. With line 174 in **O**.177. With line 176 in **O**, **R**.179. With 178 in **B**, **O**.185. Text from **K**; **B** x dūr.191. **K** gi for gi₄.193. With 191 in **C**, **K**.194. With 192 in **K**.

| | | |
|------|-----|--|
| BC | 196 | lugal-LAK 586 |
| BC | 197 | lú-šakir |
| B | 198 | mes an-túm |
| BC | 199 | gal-balag |
| BC | 200 | amar-nin |
| BR | 201 | Amar-é-bíl |
| BOR | 202 | giš-úr |
| OR | 203 | ti am |
| BKOR | 204 | gír.DU.DU |
| BKOR | 205 | Ur- ^d Dam-ki-na |
| BKO | 206 | tibir(DUB + NAGAR) |
| BKO | 207 | im-íb |
| BK | 208 | muš-laḥ ₄ |
| BK | 209 | Amar- ^d sÁR × DIŠ-gi ₄ |
| BK | 210 | PAB.PAB |
| BK | 211 | ib-li |
| BK | 212 | KA × šU |
| BK | 213 | a-é-du ₁₀ |
| B | 214 | ba-za-za um tab |
| B | 215 | é x ʾkiʾ |
| BV | 216 | LÚ × ^{ns} šU |
| BPV | 217 | da IGI + LAK 527 |
| BP | 218 | é da ra |
| BCP | 219 | ^d MI.MUŠEN-me-ru |
| BCP | 220 | sag-dùn |
| BCP | 221 | kaš |
| BC | 222 | ba-za |
| BC | 223 | SAḪAR x |
| BC | 224 | lu-lu-QA-x |
| BC | 225 | za-za-ba ₄ |
| BC | 226 | é gal al |
| B | 227 | bára ki ba ₄ |
| B | 228 | kaš ₄ -du ₁₀ |
| B | 229 | ʾudʾ-kalam |
| BR | 230 | kaskal erím |
| BR | 231 | Im-lik-il |
| BR | 232 | kurušda |
| BK | 233 | az KA × šU |
| BK | 234 | é-gud aš si |
| BK | 235 | l |
| BK | 236 | é sag aš |
| BK | 237 | ki-lum |
| B | 238 | é-nu-ma-gal |
| B | 239 | a ḥu ne |
| BP | 240 | ganun nin |

209. K gi for gi₄.213. B du₁₀ over erasure.

221. With 220 in C.

223. B x possibly EZEN(!); with line 222 in C.

224. Text from B; C ʾlu-luʾ x x; the sign transliterated x is ambiguous in both sources.

225. Text from B; C za-za-x (not ba₄).

THE NAMES AND PROFESSIONS LIST

69

| | | |
|-------------|-----|-------------------------------------|
| BKP | 241 | AB × Aš |
| BPV | 242 | ganun gal-gal ù |
| BPV | 243 | Sù-ma-me-ru |
| BPV | 244 | má-ne-dam |
| B | 245 | Ur-ḫi-li _x (šA) |
| BQ | 246 | EZEN × 'x ¹ -bíl |
| B | 247 | a-peš |
| B | 248 | SAḤAR |
| B | 249 | en-šu-du ₈ |
| B | 250 | kurušda |
| BK | 251 | ban-mes-kalam |
| BK | 252 | še lu |
| BK | 253 | Ur-sag-pa-è |
| BK | 254 | engar |
| BK | 255 | me-tag |
| BK | 256 | PISAN × SAL-gi |
| BK | 257 | Lugal-Dumu-zi |
| BK | 258 | a-dim |
| BK | 259 | pab en-du ₁₀ |
| B | 260 | PA . KAš ₄ |
| B | 261 | me-en-du ₁₀ |
| B | 262 | maš-maš |
| BP | 263 | mes-pa- ^r è ¹ |
| BP | 264 | ba-t[i] |
| BP | 265 | a-peš |
| BP | 266 | é-bíl |
| P | 267 | Ur-ḫi-li _x (šA) |
| BPQ | 268 | ganun-bulug ₃ -sar |
| BKPQ | 269 | lugal me am |
| BK | 270 | má-gur ₈ |
| BK | 271 | an-du ₁₀ |
| BK | 272 | ab-ki |
| BK | 273 | ak |
| BK | 274 | A-LAK 350-kalam |
| BK | 275 | Ur-sag- ^d Kiš |
| BK | 276 | TAG ₄ -x |
| BK | 277 | ká-gín |
| B | 278 | ki[š x] |
| | 279 | missing |
| B | 280 | ud (x) |

243. V su for sù.

244. P bíl(?) for ne; with line 243 in V.

246. Placement of Q uncertain; perhaps read bàd bíl in B.

256. PISAN × x in B.

258. K omits a; B dim partly over erasure.

269. K [lu]gal x men.

274. K ká (both kalam in B and ká in K are very clear), followed by double ruling in K.

277. Text from K; B dag (or ká!) ur gín.

280. Not more than six more lines of text, followed by colophons.

COMMENTARY

Line 8. The sign gír-*gunú* (LAK 7) is not to be confused with gír (LAK 6). The latter is used in writing ^dNin-gír-su. It is also the sign used for gír, “knife” (see occurrences in SF 20 and other Practical

Vocabularies). The distinction between the two signs was still maintained in Ur III times. (N. Schneider, in his *Keilschriftzeichen der Wirtschaftsurkunden von Ur III* [Rome, 1935] Nos. 20 and 21, has kept them apart.) Readings for gír are given in Ea (*MSL* II 89, ll. 797–800) as ul, ad, tab, mi-ri. See also ul gír = *ma-gal* (A VIII/2 255). The most convincing evidence that gír-*gunú* has a reading ul₄ is that in Ur III texts ula, “quickly,” is written gír-*gunú*-la (i.e., ul₄-la) and ú-la. Occurrences cited by Sollberger in *The Business and Administrative Correspondence under the Kings of Ur* (TCS I [Locust Valley, N.Y., 1966]) p. 184, s.v. ula which I have checked all have gír-*gunú*. gír-*gunú*-gal is also a fairly common element in personal names in the Ur III period. Some occurrences are cited by Henri Limet in *L’Anthroponymie sumérienne dans les documents de la 3^e dynastie d’Ur* (Paris, 1968) p. 332 (the interpretation as “épée” is to be disregarded). Occurrences I have checked all have gír-*gunú* and not gír, and David I. Owen of the University Museum, Philadelphia, has kindly checked additional references available to him and confirms that the two signs are consistently distinguished from each other. The interpretation of gír-*gunú*-gal in personal names (always referring to a deity), is perhaps found in the equivalence gír-gal = [šar]-*hu* (Igituh I ii 85). Derivatives of šar₄*hu* are common in personal names in Akkadian. See J. J. Stamm, *Die akkadische Namengebung* (Leipzig, 1939) index s.v. šar₄*hu*.

It is the sign gír-*gunú* which is used in šim-gír, “myrtle” (for the equivalence, see *CAD*, s.v. *asu* A). Examples are 40 ma-na šim-gír-*gunú* in H. de Genouillac, *Tablettes sumériennes archaïques* (Paris, 1909) No. 6 ii 3, and, also among aromatics, ì-gír-*gunú*-ka-kam in *VAS* XIV, No. 123 iii 4 (see Josef Bauer, *Altsumerische Wirtschaftstexte aus Lagasch*, p. 328, No. 118 and his comment on p. 88). Other examples are 7 ma-na šim-gír-*gunú* in Allotte de la Fūye, *Documents présargoniques* (Paris, 1920) No. 513 iii 3; see also F. Thureau-Dangin, *Recueil de tablettes chaldéennes* (Paris, 1903) No. 20 i 5. See also pa giš.gír-*gunú* in *RA* LIV (1960) 61, l. 47 and the discussion of Civil on p. 67.

The lexical texts give ad, aṭ-ṭu, and ki-ši as readings for gír in names of plants (see citations in *CAD*, s.v. *eddetu* and *ašāgu*). The pronunciation of gír in šim.gír = *asu* is not given. See J. J. A. van Dijk, “VAT 8382: Ein zweisprachiges Königsritual,” *Heidelberger Studien zum alten Orient* (Wiesbaden, 1967) p. 240, n. 38, citing giš.ú.gír-e in *RA* VIII 166, rev. i 69, with variant ù-še-eg-e in *VAS* II, No. 2 ii 36. However, the suggestion of M. Civil, in *JNES* XXXI (1972) 223, to read rather ki(!)-še-eg-e is to be preferred since it accords with the readings ki-ši, ki-šá, and kiš of Diri II 251. The syllable ka- in *VAS* XIV, No. 123 iii 4, cited above, is evidence that kišig/k is the reading for gír-*gunú* in šim-gír-*gunú* and giš.gír-*gunú* at least.

gír-*gunú* also occurs in names of birds. See buru₅-ú-gír-*gunú*^{mušen} and buru₅-giš-gír-*gunú*^{mušen} in *ITT* V, Pl. 52, No. 9251 + *ITT* II, Pl. 86, No. 5898 (see *MSL* VIII/2 140, and duplicate, SF 58 xi 10–11). gír-*gunú* also occurs in Gudea Cyl. A iii 11: giš.gír-*gunú*-gal-mu me zag-mu mu-ús, “you (Gatumdu) are my . . . , you are close to my side.” The reading for some of these occurrences may well be ád; it is clear in any case that none of them are to be read gír.

Line 25. La-la also occurs in WF 110.

Line 28. Note the possibly similar name Gu-sur-nun, and note that Source C has nun. See *Fara* III 24*.

Line 32. Lugal-šu-du₇ also occurs in WF 16 col. v.

Line 38. A-geštin occurs a number of times. See *Fara* III 19*.

Line 78. The sign described as IGI+LAK 527 occurs also in lines 97, 190, and 217. It is not known to me elsewhere.

Line 82. É-nu-si is a very common name. See *Fara* III 30*.

Line 88. LAK 527 also occurs as a ligature with IGI. See comment on line 78.

Line 89. Note that Ur-Zababa is apparently identified as being from Adab. Zababa does not occur as an element in personal names from *Fara*.

Line 93. Lu-lu occurs a number of times in *Fara* names. See *Fara* III 33* sub udu-udu.

Line 96. This line is perhaps represented by the illegible traces at the top of col. iv in Source C. For the sign transliterated x, see the comment on lines 104–7 of the Zà-mì Hymn collection.

Line 97. See comment on line 78.

Line 118. For the Semitic name I-ti-ì-lum, see parallels cited in *MAD* No. 3, pp. 198–99.

Line 125. For the name Ba-zi, see *Fara* III 22*.

Line 127. Cf. Ba-lul in *Fara* III 23*.

Line 132. The sign transliterated x occurs a number of times in Abū Šalābīkh texts, particularly near

the end of UD.GAL.NUN compositions. Deimel has erroneously listed it with occurrences of LAK 382 (gur₈). A typical example, in which it occurs with za_x(LAK 798), as often in our texts, is SF 56 iv 5, listed as LAK 382. It still occurs in Old Akkadian times. See *MAD* No. 4, p. 57, No. 81. I cannot suggest a reading or an interpretation for it.

Line 133. ^aMI.MUŠEN-me-ru. In *Orientalia* n.s. XXXVI 58, n. 5, I have cited some names from Fara with the element me-ru. I am now inclined to read Il-su_x(MUŠ)-me-ru, "His-God-is- . . .," in WF 124 col. iv.

Line 150. For Ur-sag, see *Fara* III 35*.

Line 159. LAK 586 probably represents a vessel with SIG₇ written inside it. I refrain from transliterating DUG × SIG₇ since the sign DUG has an additional wedge representing the spout on a pot, whereas the basic element of LAK 586 and related signs (see SF 64) does not occur alone.

Line 162. See comment on line 132.

Line 190. Perhaps a Semitic name. See comment on line 78.

Line 201. For Amar-é-bíl, see *Fara* III 22*.

Line 205. This is apparently the earliest reference to the goddess Damkina.

Line 217. See comment on line 78.

Line 219. See comment on line 133.

Line 224. See comment on line 93.

Line 231. Im-lik-il, a Semitic name, is not previously known. The related names Ì-lum-ma-lik and Il-sù-ma-lik occur in Abū Šalābikh texts. See *Orientalia* n.s. XXXVI 62.

Line 243. See my suggestion in *Orientalia* n.s. XXXVI 63, n. 2 that sù is written with the verticals crossing the horizontal wedge in Semitic inscriptions (including Semitic names), but with the verticals inside the rectangle in Sumerian. The only exception I have noted is in lines 84–85 of the Standard Professions List, where the earliest source has an anomalous sign with verticals in both places. Sù-ma-me-ru is therefore probably a Semitic name to be interpreted as "The-Name-is- . . ." See also the comment on line 133.

Line 257. Lugal-Dumu-zi is a common name in Fara texts; see *Fara* III 40*.

Line 274. See p. 34, n. 32 for discussion of LAK 350.

Line 276. The value TAG₄ is probable for the first sign in the line. The second is unknown. It was described conveniently in *MSL* XII 19, line 129 as SAG × TAG₄. A somewhat similar sign is LAK 310, but I know of no evidence to suggest that they are related except superficially.

THE LIST OF GEOGRAPHICAL NAMES

The List of Geographical Names is not paralleled by contemporary texts found elsewhere, and it seems to have no specific relationship to the forerunners of the geographical section of 𒄩AR-ra = *hubullu*.

The first thirteen lines of the composition have not been recovered, so it is not known whether or not it began with an enumeration of the major cities of Sumer. None of the important towns are included in any preserved part of the text, unless UD.ÙĜ^{ki} in line 128 refers to the famous city Akšak and not to a village with the same name or written with the same signs; lines 152–56, however, may refer to towns or topographic features in the vicinity of Kullaba.

The small fragments from the first season (AbS-T 45a–o, including two fragments which were wrongly identified) belong to at least two different tablets. Some are badly weathered on the broken edges as well as on the surface, and positive joins are therefore difficult. Two apparent joins (the top of col. iii, AbS-T 45h, to the bottom of col. ii, AbS-T 45j, and the bottom of col. i, AbS-T 45g to AbS-T 45d + 45l) are rejected solely because they are contradicted by the sequences of lines in the principal sources.

The numbering of lines and the sequence of columns have been based on the assumption (which may not be correct) that the first preserved column of No. 91 (Source B) is the same as col. iv of No. 94 (Source A). The two fragments do not join but are from the same tablet.

TRANSLITERATED TEXTS

SOURCES

| | | | |
|----------|-----------|-----------|-----------|
| A No. 94 | G No. 107 | L No. 101 | Q No. 106 |
| B No. 91 | H No. 100 | M No. 102 | R No. 97 |
| C No. 95 | I No. 110 | N No. 103 | S No. 93 |
| D No. 92 | J No. 109 | O No. 104 | T No. 105 |
| E No. 96 | K No. 108 | P No. 111 | U No. 98 |
| F No. 99 | | | |

TRANSLITERATION

| | |
|--------|---|
| 1--13 | missing |
| A 14 | [k]a ur ₄ ^{ki} |
| A 15 | ʽtiʽ nu x ^{ki} |
| A 16 | dar mu ^{ki} |
| AC 17 | ša(?) la nu ba ₄ ^{ki} |
| AC 18 | ka ʽturʽ tur ^{ki} |
| AC 19 | kur dūr ^{ki} |
| AC 20 | ri da na ^{ki} |
| AC 21 | dar e ^{ki} |
| A 22 | e ^{ki} |
| A 23 | ib nim la ^{ki} |
| A 24 | ib ʽadʽ(?) [x] ^{ki} |
| G 25 | ib da ni[m ^{ki}] |
| G 26 | ib da gal la ^{ki} |
| G 27 | tar rí an an ^[ki] |
| G 28 | a na [(x) ^{ki}] |
| 29--34 | missing |
| A 35 | ra x ^{ki} |
| A 36 | pù x rí ^{ki} |
| A 37 | ù al ^{ki} |
| AH 38 | ba ₄ ne zu ^{ki} |
| ACH 39 | gi da nu ^{ki} |
| ACH 40 | má ga ^{ki} |
| ACH 41 | si dag ^{ki} |
| AC 42 | ù til ^{ki} |
| AC 43 | nu ri ^{ki} |
| ACF 44 | i nu ^{ki} |
| ACF 45 | a ša ^{ki} |
| AG 46 | ban ga ^{ki} |
| AG 47 | la sá ^{ki} |
| AG 48 | ur ₄ ^{ki} |
| 49--58 | missing |
| A 59 | a(?) hē ^[ki] |
| A 60 | é dù ^{ki} |
| A 61 | tar rí x hu ^{ki} |
| AC 62 | zu lum ^{ki} |

17. ba for ba₄ in C.20. Perhaps [x d]ar^{ki} in C.

28. Placement of G, lines 25-28, here is uncertain.

44. A i dù nu^{ki}.45. Perhaps read a na₃^{ki}.

61. x is probably tar or nu(!).

THE LIST OF GEOGRAPHICAL NAMES

| | | |
|-----|-------|---------------------------------------|
| AC | 63 | la du ₈ ^{ki} |
| ACH | 64 | urudu urudu ^{ki} |
| ACH | 65 | ak zi ù ^{ki} |
| ACH | 66 | lâl lul ur ₄ ^{ki} |
| AC | 67 | é ur ₄ ad ^{ki} |
| AC | 68 | ša bàd ^{ki} |
| AG | 69 | é ^a Inanna ^{ki} |
| AG | 70 | bàd gàr ^{ki} |
| AG | 71 | gi nu ma ^{ki} |
| AG | 72 | šakir ^{ki} |
| B | 73 | x x |
| B | 74 | si x ad(?) ^{ki} |
| BI | 75 | [d]a(?) mu ^{ki} |
| BIJ | 76 | ambar ^{ki} |
| BIJ | 77 | sal la ^{ki} |
| BIJ | 78 | sá ma nu ^{ki} |
| J | 79 | é í[b](?) x ^[ki] |
| | 80-85 | missing |
| A | 86 | du [x ^{ki}] |
| AC | 87 | áš di ^{k[!]} |
| A | 88 | ka sar ^{ki} |
| A | 89 | egir ^{ki} |
| AK | 90 | é A GIGIR ^{ki} |
| AK | 91 | é bur-gul ^{ki} |
| AK | 92 | kar ^{ki} |
| A | 93 | dù-LAK 713 ^{ki} |
| A | 94 | sanga nun ^{ki} |
| A | 95 | ub ^{ki} |
| A | 96 | [x] zi ṛgal ^{ki} |
| B | 97 | r[i](?) ši x ^{ki} |
| BI | 98 | i zi nu ^{ki} |
| BI | 99 | é šEš + IB ^{ki} |
| BI | 100 | ši ri si ga ^{ki} |
| BI | 101 | URU × A ^{ki} |
| B | 102 | LAGAB(?) × SAL da ^{ki} |
| B | 103 | gi zi nu ^{ki} |
| B | 104 | ga ni ^{ki} |
| BE | 105 | x x din ^{ki} |
| E | 106 | x saḥar ^{ki} |
| E | 107 | [x] gur ^{ki} |
| E | 108 | [x g]al ^{ki} |
| | 109 | missing |
| E | 110 | [x] ṛdi ^{ki} |
| E | 111 | x sar ^{ki} |
| E | 112 | [x] x ^{ki} |
| E | 113 | [x x] a ^[ki] |
| AE | 114 | mar ak ka ^[ki] |

68. A ša(!).

71. G na for nu.

90. K perhaps x a túg^{ki}.

105. x is end of nun or INANNA.

- AK 115 é dur ur₄^[k1]
 AK 116 gigir dù^{k1}
 AK 117 ʰi gal^{k1}
 A 118 ra ga bàd^{k1}
 A 119 ra ma ad^{k1}
 A 120 a túg^{k1}
 B 121 a x^{k(1)}
 B 122 ma[r] x dar^{k1}
 B 123 x^{k1}
 B 124 an úr^{k1}
 B 125 du^{k1}
 BL 126 é a^{k1}
 BL 127 LAK 654^{k1}
 BL 128 UD. ùḫ^{k1}
 BE 129 dag me^{k1}
 BE 130 dúr dúr^{k1}
 BE 131 aš lál lagab^{k1}
 BE 132 gú a^{k1}
 E 133 e sa má^{k1}
 E 134 an muš^{k1}
 E 135 gu nir^{k1}
 E 136 gigir a^{k1}
 E 137 mar ak bù^{k1}
 138–40 missing
 A 141 traces
 A 142 traces
 A 143 é [
 A 144 áš x^[k1]
 B 145 MÜŠ-gunú^{k1}
 B 146 x x zi a^[k1]
 B 147 a tab^{k1}
 B 148 nam ʰi^{k1}
 B 149 é saḫar é^{k1}
 B 150 é nin(?)^{k1}
 B 151 ʿùʿ la m[a](?)^{k1}
 BEL 152 kun Kul-aba(AB)^{k1}
 BEL 153 giš-kin-ti^{k1}
 BE 154 ù giš dúr^{k1}
 BE 155 ù giš dúr Kul-aba(UNUG)^{k1}
 BE 156 giš Kul-aba(UNUG)^{k1}
 E 157 ru ru^{k1}
 E 158 ku me^{k1}
 BE 159 im im^{k1}
 E 160 é luḫ x^{k1}
 161–69 missing
 B 170 rad^{k1}
 B 171 a[n] x^{k1}

131. Traces in B are possibly to be interpreted as áš.

132. gu for gú in B.

144. x perhaps b[ād].

152. L omits aba.

THE LIST OF GEOGRAPHICAL NAMES

- B** 172 sar da^{ki}
B 173 tar rí šul^{ki}
BE 174 tar rí da zi^{ki}
BE 175 tar rí sag du₈^{ki}
BE 176 é t[a](?)^{ki}
BE 177 kun^{ki}
BE 178 giš an šinig^{ki}
BE 179 du₈ umbin^{ki}
BE 180 ka nu ni gi^{ki}
BE 181 ad-KID^{ki}
BE 182 nun GIŠ ŠID^{ki}
BE 183 ambar^{ki}
 184–92 missing
B 193 traces
B 194 traces
B 195 gígir^{ki}
B 196 tar rí me^{ki}
B 197 ne g[iš](?) gišimmar(?)^{ki}
B 198 KA KA lum^[ki]
B 199 sar ra lum^{ki}
B 200 x i ka^{ki}
B 201 a lu lum^{ki}
B 202 pirig tur^{ki}
B 203 edin^{ki}
B 204 x du^{ki}
B 205 tar rí til^{ki}
B 206 ná^{ki}
B 207 giš ʾti¹ x^[ki]
 208–16 missing
B 217 traces
M 218 [x] mu^{ki}
BM 219 ḥi mu ur₄^{ki}
BM 220 kum mu ur₄^{ki}
B 221 da ne^{ki}
BN 222 ú ši^{ki}
BN 223 ud ud^{ki}
N 224 i šÁR × Aš [u]r₄(?)^{ki}
BN 225 gu ʾne^{1[ki]}
BN 226  GÍD kalam^[ki]
B 227 ša ne^{ki}
B 228 ša mu^{ki}
B 229 du ši^{ki}
B 230 é ad ur₄^{ki}
 231–41 missing
M 242 šu sar x^[ki]
M 243 ni lu lál x^[ki]

178. Probably šinig rather than nisaba.

225. Perhaps more in N.

227. ša should perhaps be transliterated na₈.

242–43. M, belonging to this column, has been placed here arbitrarily. Col. iii of N (mostly illegible) probably belongs in some of the following lines.

| | | |
|------------|--------|--|
| B | 244 | traces |
| B | 245 | ši x[|
| B | 246 | da [|
| B | 247 | a[d(?) |
| B | 248 | ka x[|
| | 249 | missing |
| B | 250 | traces |
| B | 251 | mu[n |
| BO | 252 | é pi ur ₄ ^{ki} |
| B | 253 | ga rí [|
| BE | 254 | é [|
| | 255 | missing |
| P | 256 | [x u]nug ^{ki} |
| P | 257 | [x x] igi ni ^{ki} |
| | 258-74 | missing |
| B | 275 | sa an ^{ki} |
| B | 276 | mar na ^{ki} |
| BP | 277 | mar na ur ₄ ^{ki} |
| BP | 278 | ú ad ^{ki} |
| BP | 279 | sá ma x ^{ki} |
| B | 280 | ma dar ^{ki} |
| B | 281 | dù ga ra ^{ki} |
| B | 282 | tab nu ^{ki} |
| B | 283 | é ir erím ^{ki} |
| BNR | 284 | tar rí šU. ʃA ^{ki} |
| BNR | 285 | x ^{ki} |
| BN | 286 | ša ne ^{ki} |
| BN | 287 | sá ma nu ^{ki} |
| BN | 288 | ši ri a si ^{ki} |
| | 289-98 | missing |
| B | 299 | da ka ^{ki} |
| BP | 300 | al húl(LAK 183) ^{ki} |
| BP | 301 | da bur ^{ki} |
| B | 302 | sum bàd ^{ki} |
| B | 303 | za ra bàd ^{ki} |
| B | 304 | é me tag ^{ki} |
| B | 305 | az a ni ^{ki} |
| B | 306 | ud uš ^{ki} |
| B | 307 | a lu ^{ki} |
| B | 308 | pab nám ^{ki} |
| B | 309 | il íb ^{ki} |
| B | 310 | ba ₄ ra mu ^{ki} |
| B | 311 | a-gír-guná ^{ki} |
| B | 312 | [d]u ₈ a(?) gud ^{ki} |
| | 313-22 | missing |
| B | 323 | tùm um ^{ki} |

256-57. P, belonging to this column, has been placed here arbitrarily.

258-74. Col. iv of N belongs in this gap (mostly illegible

except for BÀD^{ki} and ANŠE.UŠ^(ki)), and probably the left column of O ([x] x bù^{ki}) as well.

286. Perhaps read na₆-nc.

THE LIST OF GEOGRAPHICAL NAMES

77

- B 324 rí sá sar^{kl}
 B 325 rí sá ud ní sar^{kl}
 B 326 m[e] ak^{kl}
 BQ 327 tu bíl^{kl}
 BQ 328 a li la^{kl}
 BQ 329 mu rí rí^{kl}

328. lji na^{kl} in Q.

[Followed by colophons.]

Unplaced fragments:

D

i

- 1] ù^{kl}
 2] x sí^{kl}
 3] x^{kl}

ii

- 1 a tí^{kl}
 2 me sa ma nu^{kl}
 3 ba₄ ra mu^{kl}
 4 ra hí^{kl}

S

i

- 1 x lul ta(?)^{kl}
 2 x ne^{kl}
 3 ù(?) gal gal^{kl}
 4 [x s]i IGI + LAK 527^{kl}

ii traces

T

- 1 [x] mu dar^{kl}
 2 LÚ × BAD ga nu^{kl}
 3 sí sá^[kl]

U

ii

- 1 a x [x^{kl}]
 2 ršid^l(?) [x x^{kl}]

COMMENTARY

Line 48. A geographical name Ur₄^{kl} occurs in No. 508 (administrative document).

Line 123. Although written differently, the sign in this line is the Abū Šalābīkh equivalent of LAK 387. Scribes at both sites were consistent in their writing of it. That they are equivalent is shown by duplicates such as No. 46 ix 7 and SF 57 and also by the frequent combination with TAG₄ (e.g., *MSL* XII 18, l. 113).

Line 132. Gú a^{kl} occurs in No. 508 (administrative document).

TRANSLITERATED TEXTS

Line 145. No other occurrences of *mùš-gunû* (read *Tišpak* in later times) are known to me in archaic texts.

Line 226. The line occurs a number of times in other texts. See the comment on lines 52–58 of the *Zà-mi Hymns*.

Line 285. The sign transliterated *x* is a sign, which, at least in No. 6 and in the Fara duplicate SF 15, corresponds to LAK 382. The sign is rare in *Abū Šalābikh* texts.

Line 311. See the comment on line 8 of the *Names and Professions List* for discussion of the sign *GÍR-gunû*.

CATALOGUE OF PUBLISHED TEXTS

LEXICAL TEXTS

No. 1. A composite copy of the texts of the early pre-Sargonic professions list (Standard Professions List) appeared in *MSL XII* (Rome, 1969) Pl. 1, and a critical edition was given on pp. 4–12. A new copy has been made for this volume. It is based on Source A for lines 1–54 (except for lines 31–33, where A differs from all other sources) and on Source B for lines 55–129 (with the exception of line 86, which is from Source G; B has an erroneous sign in this line). In line 21 the transliteration in *MSL XII* should read *rúg:LAK 727*.

| FIELD NUMBER | SOURCE | FIELD NUMBER | SOURCE |
|-----------------|--------|--------------|--------|
| AbS-T 1 | A | AbS-T 213 | H |
| 75 | C | 214 | I |
| 102 | D | 215 | B |
| 103 | E | 392 <i>d</i> | J |
| 128 | F | 392 <i>f</i> | K |
| 144 <i>a, b</i> | G | | |

The colophon of Source B is published here as No. 483, and that of Source I as No. 487. AbS-T 331 (exercise tablet), covering lines 107–10 and 126–29, has been identified since the edition in *MSL XII* was made. An additional source is LB 942 in the Liagre Böhl Collection, communicated to me by Dr. Klaus Veenhof, of Leiden. A further source is 6 NT 746 (+) 747, a carefully written Ur III copy, preserving the upper left and lower right corners. Both are without variants to the standard version. (In line 24, *silā₄* is written in its Ur III form, *PISAN × PA.*) An additional copy is N. 5566 (+) N. 5655 (University Museum, Philadelphia).

No. 2. AbS-T 1. Photo of obverse. See No. 1. The tablet was baked. See Fig. 29 for the design on the reverse.

No. 3. Photo of obverse of AbS-T 144*a* and *b* (fragments of the same tablet). It is published here separately since it is among the few tablets from an early level. The colophon in the last column on the smaller fragment has only *SANGA* preserved. The colophon is not separated from the text itself, as is customary.

No. 4. AbS-T 145. Duplicate of SF 64, corresponding to col. i l. 16–col. ii l. 6 (with variant or added line with inscribed *SUKKAL*), col. iii ll. 3–10 (with inscribed *DUB* rather than *MES* in line 9), and col. v l. 15–col. vi l. 2 (with parts of the Fara version omitted). This list belongs to the earlier scholarly tradition. See Langdon, in *Journal of the Royal Asiatic Society*, 1931, p. 842, also Falkenstein, *Archaische Texte aus Uruk* (Berlin, 1936) p. 45.

No. 5. AbS-T 143. Photo. Duplicate of No. 6 and SF 16 and 17, with variants in column i.

No. 6. AbS-T 151. Duplicate of No. 5 and SF 16 and 17. Note that the form of the sign in col. ii l. 5 differs from the Fara copy (col. ii l. 1).

No. 7. AbS-T 261. Duplicate of SF 64 i 4 and ii 1–4.

No. 8. AbS-T 139*c*. Duplicate of SF 64 iv 1(?) and v 1.

- No. 9. AbS-T 330. Exercise tablet. Duplicate of SF 64 i 6–9, ii 5(?)–7(?), iii 11–13. The reverse has some obliterated writing (not copied).
- No. 10. AbS-T 81. List of names of fish. Duplicate of SF 9–11. Not collated (suḥur rather than sumāš in col. ii l. 6 is thus not confirmed).
- No. 11. AbS-T 244. List of names of fish. Duplicate of SF 9–11. In column i, sila₃ du₁₀ ku₆ is certain, but the Fara version has not been verified.
- No. 12. AbS-T 403a. List of names of fish. Duplicate of SF 9–11.
- No. 13. AbS-T 254. Duplicate of SF 9 rev. i 20 to end, with two additional lines, possibly part of a colophon. This is to be considered a separate text from the fish list of SF 9–11. It is not included in SF 10 and is separate in the Abū Ṣalābikh copies. Other duplicates are No. 46, in Louis Speleers, *Recueil des inscriptions de l'Asie Antérieure des Musées Royaux du Cinquantenaire à Bruxelles* (Brussels, 1925), and A3670 (Oriental Institute, of unknown provenience); the latter was identified by A. Westenholz. Nos. 14–17 belong to the same list.
- No. 14. AbS-T 253. Photo of obverse. Duplicate of SF 9. See description of No. 13.
- No. 15. AbS-T 118. Duplicate of No. 14 and SF 9. See description of No. 13.
- No. 16. AbS-T 115. Duplicate of No. 14. See description of No. 13.
- No. 17. AbS-T 392o. Duplicate of No. 14. See description of No. 13.
- No. 18. AbS-T 141. Photo of reverse of tablet listing wooden objects. There are only traces of writing on the obverse. This tablet and No. 19 come from Level IC and are consequently earlier than most of the tablets. See ch. 1 for discussion. The tablet was baked, probably accidentally. A few lines are duplicated in No. 20.
- No. 19. AbS-T 142. List of wooden objects. Belongs almost certainly to the same tablet as No. 18.
- No. 20. AbS-T 251. List of wooden objects, with colophon in the last column. See No. 18.
- No. 21. AbS-T 294. List(?). From this copy it can be seen that the text begins with names of cities: [. . .], Nippur, Larsa, Uruk, Kesh, Zabalam and Eresh. Duplicate of No. 22 and SF 23, which provided some variants and restorations. Note nun-kid instead of nin-kid (Fara copy verified). I cannot reconcile the traces in col. iii l. 12 with the duplicate. In col. iv l. 3 the signs are smashed. In col. iv l. 13 of SF 23 bar is written Aš, as the duplicate shows.
- No. 22. AbS-T 392q. Duplicate of No. 21.
- No. 23. AbS-T 219. Principally a list of plants. Photo. Duplicate of SF 58 (not including the bird section). Partially edited with other duplicates by Civil and Biggs, in *RA LX* (1966) 8–11. No. 24 has now been joined to its left side (confirmed for me by Dr. Adbul Hadi al-Fouadi). The line with dumu in No. 24 is opposite giš-lá.
- No. 24. AbS-T 303. Joined to No. 23, q.v.
- No. 25. AbS-T 286. List of animals, precursor to Hh. XIII. Duplicate of SF 81. Colophon on reverse. See *JCS XX* (1966) 84. See No. 26.
- No. 26. AbS-T 392a. Fragment of No. 25.
- No. 27. AbS-T 392r. Text similar to Nos. 25 and 26, but not from the same tablet.
- No. 28. AbS-T 242. List of animals, mostly domestic. In col. ii l. 7 probably read 'Aš + SAL + GAR'. Interpretation of the reverse is uncertain, but it is unlikely to be a colophon. Cf. SF 81.
- No. 29. AbS-T 152. List of signs in various combinations, similar to SF 7.
- No. 30. AbS-T 342. List of words including wools. The preserved portion is the reverse of the tablet. There are only a few slight traces of writing on the obverse.
- No. 31. AbS-T 165. List of words(?).
- No. 32. AbS-T 133. List of compounds with ninda or níg. The surface is somewhat convex.

- No. 33. AbS-T 343. Photo of obverse. Practical Vocabulary, similar in some sections to SF 20 and duplicates. Although later Practical Vocabularies are inscribed on cylinders (see V. Scheil, "Vocabulaire pratique, Suse, époque d'Ur," *RA* XVIII [1921] 49–78 for an example), the nature of the list seems to justify calling it a Practical Vocabulary. The reverse includes a badly damaged colophon. See *JCS* XX 83.
- No. 34. AbS-T 92. Practical Vocabulary. Duplicate of SF 20–22. Lists stones (za_x) (see Biggs, in *RA* LX 175–76), stone bowls, beds, metals, clothing, sheep, and the like. The reverse has a colophon. The copy of the obverse is based on a preliminary field copy made in 1963. The tablet was temporarily unavailable when I made collations in Baghdad. I owe several corrections to collations made for me subsequently by Dr. Abdul Hadi al-Fouadi. Note peš_x(šA) as variant for peš₄ in the name of the sea shell in bur-peš_x-SAL.ANŠE, "bowl of 'donkey mare's vulva' shell," in col. ii l. 5'. The line markers consist of holes up to 2 cm. deep made with the rounded end of the stylus.
- No. 35. AbS-T 87a. Practical Vocabulary.
- No. 36. AbS-T 139g. Perhaps a Practical Vocabulary.
- No. 37. AbS-T 163. Perhaps a Practical Vocabulary.
- No. 38. AbS-T 369. Perhaps a Practical Vocabulary.
- No. 39. AbS-T 311 + 384a + 384b. Word list whose nature is unclear to me. Colophon continues on the reverse. AbS-T 384a and 384b constitute the top part of column v. (The join of AbS-T 384b was discovered by Dr. Abdul Hadi al-Fouadi, of the Iraq Museum, to whom I express thanks.) Duplicates are Nos. 40–43.
- No. 40. AbS-T 387f. Duplicate of No. 41. See No. 39.
- No. 41. AbS-T 301. See No. 39.
- No. 42. AbS-T 312. Duplicate of No. 39. The colophon is in the last two columns. The thickest part of the tablet is just to the left of igr in column i.
- No. 43. AbS-T 310. Duplicate of No. 39. The colophon is on the reverse. Not collated.
- No. 44. AbS-T 243. Probably at least in part a list of temple officials and cultic personnel. Duplicate of SF 57. Column ii corresponds to SF 57 ii 16–iii 6. In re-examining the original tablets, I believed this tablet should join No. 48 (not possible at present without laboratory work), but this seems excluded by e[n] in column iii, which is also preserved for the same line in No. 48. Nos. 45–53 belong to the same list.
- No. 45. AbS-T 110. Duplicate of SF 57. See the description of No. 44.
- No. 46. AbS-T 221 + 372a. Duplicate of SF 57. The colophon is in column xii. Note that there are many divergences from the Fara version. See the description of No. 44.
- No. 47. AbS-T 222. Photo. Duplicate of SF 57. The reverse was previously published in *JCS* XX 83, Fig. 3. The columns on the reverse are in the sequence right to left (see the end of the list in No. 46). See the description of No. 44.
- No. 48. AbS-T 224. Duplicate of SF 57. See the description of No. 44.
- No. 49. AbS-T 238e. Duplicate of SF 57 iv 13–14. See the description of No. 44.
- No. 50. AbS-T 238c. Duplicate of SF 57 iii 11–12. See the description of No. 44.
- No. 51. AbS-T 238b. Duplicate of SF 57. Column ii corresponds to SF 57 iv 10–11, with an additional line. Column i is unplaced. See the description of No. 44.
- No. 52. AbS-T 225. Duplicate of SF 57. Column ii corresponds to SF 57 v 7–8. See the description of No. 44.
- No. 53. AbS-T 223. Duplicate of SF 57. The sequence of columns on the reverse is left to right. Fragment of a design on the left part of reverse. See the description of No. 44.

LIST OF PROFESSIONS

Nos. 54–60. List of professions. Edited in *MSL* XII 16–21 as Early Dynastic List E. Dr. Claus Wilcke, of Munich, has called my attention to the fact that No. 35 in *MAD* No. 5, p. 31, is a duplicate and is particularly relevant for lines 190–95. The following changes in the edition in *MSL* XII should be noted:

line 3: read ḥ¹-du_g

line 5: read [x]-si

line 42: read má-gín

line 44: a sign similar to ANŠE, rather than LUL, is probably to be read

line 54: Source B (No. 55) has arad (not arad₂), perhaps over an erasure

lines 59–60: omitted in Source A (No. 60)

line 84: reading very doubtful

line 85: illegible

line 132: read nu-SAR

line 142: read perhaps lú-si[la₄]

line 158: read UM:KID

No. 54. AbS-T 232*a* + *b* + *e* + *f*.

No. 55. AbS-T 231. Perhaps from the same tablet as No. 59.

No. 56. AbS-T 232*c*.

No. 57. AbS-T 72.

No. 58. AbS-T 375.

No. 59. AbS-T 239. Colophon in the right column. Perhaps from the same tablet as No. 55.

No. 60. AbS-T 235. There is a design on the reverse.

NAMES AND PROFESSIONS LIST

Nos. 61–81. Names and Professions List. See brief discussion, *JCS* XX 82–83, and the critical edition, pp. 62–71 above.

No. 61. AbS-T 230. Photo of obverse. The colophon is in the last column on the right. Parts of the reverse seem to have been deliberately obliterated. It consists of personal names, presumably of scribes. There is some doubt that the fragments of the reverse have all been rejoined correctly. See No. 62.

No. 62. AbS-T 234. The fragment is almost certainly the upper left corner of No. 61, but if so, the reverse fragments of No. 61 have been joined wrongly since a fit is now impossible.

No. 63. AbS-T 232*d*.

No. 64. AbS-T 249.

No. 65. AbS-T 237*a*.

No. 66. AbS-T 319*a*.

No. 67. AbS-T 164. The left column is unplaced.

No. 68. AbS-T 336*b*.

No. 69. AbS-T 236*a*.

No. 70. AbS-T 319*b*.

No. 71. AbS-T 389*b*. The place of the left column in the composition is unknown.

No. 72. AbS-T 317*h*.

No. 73. AbS-T 248 + 240. AbS-T 240 is the lower fragment.

LIST OF GEOGRAPHICAL NAMES

83

- No. 74. AbS-T 238a + 241. The surface is badly shattered and severely damaged by worms. AbS-T 241 is the upper left fragment.
- No. 75. AbS-T 341.
- No. 76. AbS-T 237b.
- No. 77. AbS-T 336a.
- No. 78. AbS-T 316.
- No. 79. AbS-T 255.
- No. 80. AbS-T 166.
- No. 81. AbS-T 315. The place of the traces in the last column on the right in the composition is unknown. They are perhaps part of the colophon.

LISTS OF GODS

- No. 82. AbS-T 200 + 207. AbS-T 200 is a small fragment joined to the upper left part of the tablet. The beginning of the list is not preserved, but it can be restored with probability as [An], [^dEn-líl], [^dNin]-KI_D, [^dE]n-ki, [^dš]E[š.ki], ^dInanna, ^dInanna-[x-x], ^dNin-gír-su, ^dšAR × DIš-[g]i₄. For the sequence on the reverse, see J. van Dijk, in *Acta Orientalia XXVIII* (1964) 6–8. The lower part of the reverse is crushed and shattered. The traces copied in some lines are consequently particularly uncertain. Duplicates No. 86. The right column of the reverse is duplicated in No. 83.
- No. 83. AbS-T 206 + 210. The signs near the right edge are smoothed out, not broken. AbS-T 210 has been joined to the reverse on the left side. Note in col. ii l. 3 (if the traces are copied correctly) that gar(?) occurs but is lacking in the duplicates. Obverse, column ii duplicates column vi of No. 86. Column xiii duplicates No. 82 reverse, right column.
- No. 84. AbS-T 209. The obverse duplicates No. 83 obv. iii–vi.
- No. 85. AbS-T 139e. Perhaps not a god list.
- No. 86. AbS-T 208. The first preserved name is [^dNis]aba. Duplicate of No. 82.
- No. 87. AbS-T 212b.
- No. 88. AbS-T 212a.
- No. 89. AbS-T 63. Note ^dAmar-utu. The rare sign AD × ÉŠ occurs also in No. 242.
- No. 90. AbS-T 211.

LIST OF GEOGRAPHICAL NAMES

- Nos. 91–111. List of geographical names. See brief discussion, *JCS* XX 84. A critical edition is given above, pp. 71–78.
- No. 91. AbS-T 201. Obverse on Pl. 49, reverse on Pl. 50. No. 92 (AbS-T 204) and No. 94 (AbS-T 202) are parts of the same tablet, but there is no physical join.
- No. 92. AbS-T 204. Belongs to the same tablet as Nos. 91 and 94, but its place is unknown.
- No. 93. AbS-T 99.
- No. 94. AbS-T 202. Obverse, Pl. 51, reverse, Pl. 52. See the description of No. 91.
- No. 95. AbS-T 203.
- No. 96. AbS-T 205.
- No. 97. AbS-T 139a.
- No. 98. AbS-T 317a. Identification not completely certain. Perhaps from the same tablet as No. 433.

- No. 99. AbS-T 362.
 No. 100. AbS-T 45*b*.
 No. 101. AbS-T 45*g*.
 No. 102. AbS-T 45*m*.
 No. 103. AbS-T 45*a*. Badly weathered fragment.
 No. 104. AbS-T 45*n*.
 No. 105. AbS-T 45*f*.
 No. 106. AbS-T 45*o*.
 No. 107. AbS-T 45*j*.
 No. 108. AbS-T 45*c*.
 No. 109. AbS-T 45*i*.
 No. 110. AbS-T 45*h*.
 No. 111. AbS-T 45*d+l*. The join was kindly confirmed for me by Dr. Abdul Hadi al-Fouadi.

LITERARY TEXTS

- Nos. 112-254. UD.GAL.NUN. See the discussion in ch. 3.
- No. 112. AbS-T 77 + 55. Photo. Fully inscribed on both obverse and reverse. The identification of obverse and reverse is not completely certain. If the proposed identification is correct, the sequence of the columns on the reverse is probably left to right, with the colophon having been on the missing right portion. No. 143 is a part of the same tablet. No. 189 may also be from this tablet.
- No. 113. AbS-T 274.
- No. 114. AbS-T 247.
- No. 115. AbS-T 266 + 273. The join between these two fragments was confirmed for me by Dr. Abdul Hadi al-Fouadi, who also arranged for a photograph of the rejoined pieces. Because of wide cracks and distortions in the tablet, it is particularly difficult to determine with certainty which lines in column iii and iv should be joined, and the choice made may prove incorrect. The unscribed reverse of AbS-T 266 has not been indicated in the copy of the reverse. Cf. Nos. 178 and 427. The rare sign LAK 592 also occurs in No. 132.
- No. 116. AbS-T 228. The colophon is in the last column. The tablet is severely cracked and split. The joins made on paper appear to be correct, but it is possible that in columns viii and ix an additional line will need to be intercalated. Duplicates are Nos. 117, 146, 151, 165 and 166. See p. 32 for discussion of some of the variants.
- No. 117. AbS-T 282. Duplicate of No. 116. See description of No. 116 for other duplicates. Wedges in this tablet are unusually deep. Impressions of the fibers of the stylus are visible in many of them.
- No. 118. AbS-T 268. Interpretation of the traces in col. iii l. 1 is uncertain. There is perhaps part of an erased sign. Note UD-Mar-tu in col. v.
- No. 119. AbS-T 298. The cracks indicated in the left part are wide and deep. Duplicates Nos. 120 and 121. The reverse has a trace of a ruling for the colophon on the left side.
- No. 120. AbS-T 220. Duplicates Nos. 119 and 121.
- No. 121. AbS-T 276. Duplicates Nos. 119 and 120.
- No. 122. AbS-T 260*a*. See No. 156.

- No. 123. AbS-T 267. There was probably one column on the right beyond the area now broken out. See the description of No. 153 for parallels to the end of the text. No. 131 is a duplicate.
- No. 124. AbS-T 258. This tablet is unusually thick and has unusually wide columns. The names in the colophon are preceded by SANGA. Cf. No. 427.
- No. 125. AbS-T 33*b*. Duplicate of No. 128 cols. ix and x(?).
- No. 126. AbS-T 338. The fragment is from a reverse since the left column is part of the colophon.
- No. 127. AbS-T 33*a*. Duplicate of No. 128.
- No. 128. AbS-T 344. Photo. Duplicate of Nos. 125 and 127.
- No. 129. AbS-T 275. The middle part of the tablet is severely smashed, and column viii is particularly uncertain. Note the exceptional occurrence of the sign NA, not preserved in the duplicate, No. 142. There is a large uninscribed area to the left on the reverse.
- No. 130. AbS-T 398. Only the reverse is preserved. There is a large uninscribed area on the left. Note Inanna zà-mì. See the description of No. 142.
- No. 131. AbS-T 270. The reverse is on Pl. 78. Duplicates Nos. 123, 134, and 185. Note ¹UD¹.MI.MUŠEN zu_x in column iv, but UD.MI.MUŠEN su in column v.
- No. 132. AbS-T 380*a*. The rare sign LAK 592 in col. ii l. 2 also occurs in No. 115 col. i. Duplicate of No. 162. It is almost certain that No. 153 is the lower right corner of this tablet.
- No. 133. AbS-T 272.
- No. 134. AbS-T 324. Duplicates No. 131.
- No. 135. AbS-T 339*a*.
- No. 136. AbS-T 265. Note the two distinct forms of TA in column iii.
- No. 137. AbS-T 304.
- No. 138. AbS-T 379.
- No. 139. AbS-T 389*d*.
- No. 140. AbS-T 389*c*. Note ¹Aš_x(šAR × DIŠ)-[g]₄.
- No. 141. AbS-T 401. The right column is a colophon. See the discussion of No. 142.
- No. 142. AbS-T 363. Photo of obverse. Some lines from the reverse are cited above, p. 32. The lower center preserved portion of the reverse is the thickest part of the tablet. It is somewhat crushed from supporting the weight of this very heavy tablet. The reverse is duplicated by No. 129. Note that here, as in other texts in this volume (Nos. 130, 141, 342, 346 and 388), zà-mì, "praise," occurs at the end or near the end of the composition. Similar occurrences in Fara literary texts are in SF 36, 39, and 56. Three very small fragments probably from this tablet (not catalogued separately) have not been copied. Each has one legible sign: kinda, erin, and zadim.
- No. 143. AbS-T 74. Same tablet as No. 112, but does not join it. See also No. 189.
- No. 144. AbS-T 260*d*.
- No. 145. AbS-T 65.
- No. 146. AbS-T 309. Colophon in column iii. Duplicates Nos. 116 and 117.
- No. 147. AbS-T 260*b*.
- No. 148. AbS-T 405.
- No. 149. AbS-T 404.
- No. 150. AbS-T 403*e*.
- No. 151. AbS-T 296. Photo. Duplicates No. 116, etc. It is probable that No. 166 is a fragment of this tablet.

- No. 152. AbS-T 146. Not collated. Duplicates No. 153.
- No. 153. AbS-T 402. Duplicates No. 152. The end of the composition is similar to several in Fara texts. See my comment on NTSŠ 82 on p. 41. See also Nos. 162 col. x and 199 col. iv. It is almost certain that this fragment is the lower right corner of No. 132.
- No. 154. AbS-T 360 *obv.* The reverse is too illegible to copy. It is probably an exercise tablet. Identification as UD.GAL.NUN is not certain.
- No. 155. AbS-T 410*a.* Identification as UD.GAL.NUN is not completely certain.
- No. 156. AbS-T 410*b.* The fragment may belong to the right side of the reverse of No. 122 but there is no join.
- No. 157. AbS-T 155. Nos. 157–61 have been grouped together because of the occurrence in all of them of the combination mar-URU-ta; it also occurs in No. 162 col. i.
- No. 158. AbS-T 376*b.* See the comment on No. 157.
- No. 159. AbS-T 56. Possibly the same tablet as No. 160 but the fragments do not join. See the comment on No. 157.
- No. 160. AbS-T 62. See the comment on Nos. 157 and 159.
- No. 161. AbS-T 61. The writing slants somewhat. See the comment on No. 157.
- No. 162. AbS-T 269*a.* Photo. Duplicate of No. 132. Note the occurrence of the sign NA in column i in a line probably to be read [g]i-gu-na, perhaps corresponding to later gi-gù-na. Column x duplicates No. 153 rev.
- No. 163. AbS-T 358. The colophon in column xii appears to be followed by additional textual matter (note the line markers).
- No. 164. AbS-T 277.
- No. 165. AbS-T 297. Duplicates No. 166. For other duplicates, see the description of No. 116.
- No. 166. AbS-T 287. See the description of No. 165. It is probable that this fragment is a part of No. 151.
- No. 167. AbS-T 271. The script of this tablet is somewhat awkward.
- No. 168. AbS-T 264.
- No. 169. AbS-T 378.
- No. 170. AbS-T 339*b.*
- No. 171. AbS-T 340.
- No. 172. AbS-T 357.
- No. 173. AbS-T 348.
- No. 174. AbS-T 307. Identification as UD.GAL.NUN is uncertain.
- No. 175. AbS-T 290. Colophon in column iv.
- No. 176. AbS-T 325.
- No. 177. AbS-T 321.
- No. 178. AbS-T 291*a.*
- No. 179. AbS-T 291*c.*
- No. 180. AbS-T 109.
- No. 181. AbS-T 117. Not collated. Probably the colophon is in column iii.
- No. 182. AbS-T 88.
- No. 183. AbS-T 139*h.*
- No. 184. AbS-T 176.
- No. 185. AbS-T 84. Duplicates Nos. 131 (with some variants) and 186.

- No. 186. AbS-T 291*b*. Duplicates Nos. 131 and 185.
- No. 187. AbS-T 392*t*.
- No. 188. AbS-T 148.
- No. 189. AbS-T 35. Perhaps the same tablet as No. 112, although it does not join and does not come from the same locus. Cf. No. 205 col. iv. See also No. 143.
- No. 190. AbS-T 57.
- No. 191. AbS-T 40.
- No. 192. AbS-T 100. Note *gír-gunú* erin, "myrtle, cedar."
- No. 193. AbS-T 59.
- No. 194. AbS-T 13.
- No. 195. AbS-T 19. A large lump of clay adheres to the surface of the tablet.
- No. 196. AbS-T 27.
- No. 197. AbS-T 121.
- No. 198. AbS-T 97. The wedges are unusually deep in this fragment.
- No. 199. AbS-T 82. See the description of No. 153 for parallels to column iv.
- No. 200. AbS-T 278*b*.
- No. 201. AbS-T 349.
- No. 202. AbS-T 45*e*.
- No. 203. AbS-T 288.
- No. 204. AbS-T 285. Designation of obverse and reverse is uncertain.
- No. 205. AbS-T 313. For column iv, cf. No. 189 col. ii.
- No. 206. AbS-T 392*s*.
- No. 207. AbS-T 106.
- No. 208. AbS-T 380*c*.
- No. 209. AbS-T 380*b*.
- No. 210. AbS-T 64.
- No. 211. AbS-T 278*a*.
- No. 212. AbS-T 122.
- No. 213. AbS-T 52.
- No. 214. AbS-T 392*h*.
- No. 215. AbS-T 173.
- No. 216. AbS-T 41.
- No. 217. AbS-T 380*d*.
- No. 218. AbS-T 323. Designation of obverse and reverse is uncertain.
- No. 219. AbS-T 353.
- No. 220. AbS-T 364.
- No. 221. AbS-T 289.
- No. 222. AbS-T 300.
- No. 223. AbS-T 350.
- No. 224. AbS-T 30 + 31.
- No. 225. AbS-T 87*b*. Identification as UD.GAL.NUN is uncertain. Duplicates No. 226.
- No. 226. AbS-T 412. Identification as UD.GAL.NUN is uncertain. Duplicates No. 225.
- No. 227. AbS-T 34. Identification as UD.GAL.NUN is uncertain.

- No. 228. AbS-T 156.
- No. 229. AbS-T 177. Identification as UD.GAL.NUN is not entirely certain.
- No. 230. AbS-T 389*g*.
- No. 231. AbS-T 392*j*. Not UD.GAL.NUN. Duplicate of No. 283 col. ii.
- No. 232. AbS-T 392*p*.
- No. 233. AbS-T 392*m*.
- No. 234. AbS-T 407*a*. Probably UD.GAL.NUN, from the reverse of a tablet. The colophon is in the left column.
- No. 235. AbS-T 28. The cases are very irregular in this tablet.
- No. 236. AbS-T 32. Identification as UD.GAL.NUN is uncertain.
- No. 237. AbS-T 413.
- No. 238. AbS-T 29*a*. Probably the same tablet as Nos. 239 and 243.
- No. 239. AbS-T 29*b*. Probably the same tablet as Nos. 238 and 243.
- No. 240. AbS-T 29*f*.
- No. 241. AbS-T 29*i*.
- No. 242. AbS-T 29*h*. The rare sign AD × ÉŠ occurs also in No. 89.
- No. 243. AbS-T 29*c*. Note the occurrence of nam in this fragment. Even though I have believed that the sign does not occur in Abū Salābikh UD.GAL.NUN texts, I tentatively include the fragment here. From the configurations on the back of these surface-layer fragments (see comments on p. 22), I believed when I made the field catalogue in 1963 that the fragments AbS-T 29*a–c* belonged to the same tablet and were originally near one another.
- No. 244. AbS-T 29*e*.
- No. 245. AbS-T 29*g*.
- No. 246. AbS-T 29*j*.
- No. 247. AbS-T 29*d*.
- No. 248. AbS-T 333. The obverse is virtually illegible. There are a number of uncertainties in the copy. Most of the reverse is duplicated by SF 37 col. xiii and NTSSŠ 117 + 314, showing that ŠAR × DIŠ can be interpreted as kam. See *JCS* XXIV (1971) 1–2 for other possible readings.
- No. 249. AbS-T 407*b*.
- No. 250. AbS-T 246. Identification as UD.GAL.NUN is uncertain.
- No. 251. AbS-T 317*e*. Duplicate of No. 252. Identification as UD.GAL.NUN is quite uncertain.
- No. 252. AbS-T 314. See description of No. 251.
- No. 253. AbS-T 283. Exercise tablet, severely damaged and split by salt. Concerned in large part with Nanna. Identification as UD.GAL.NUN is uncertain. Note Akšak on the reverse, also the writing of giri-zal (see *ZA* LXI [1971] 206). A photo of the obverse is given in Fig. 20.
- No. 254. AbS-T 292. Parts of the obverse are virtually illegible. Note that in some occurrences the wedges in the lower part of NISABA have the heads at the bottom. See No. 323. Wedges belonging to the sign MUNSUB in col. i were inadvertently omitted from the copy.

WISDOM TEXTS

- No. 255. AbS-T 218. Photo. Proverbs or sayings. See *JCS* XX 78–80 and *RA* LX 5–7. See the description of SF 26 and duplicates (p. 37).
- No. 256. AbS-T 393. Instructions of Shuruppak. Photos on Pls. 113 and 114; autograph copies on Pls. 111 and 112. Some lines have been cited in *JCS* XX 78 and *RA* LX 4–5. A transliteration of some lines with Old Babylonian parallels is given above, pp. 57–61.

LITERARY TEXTS

89

THE ZA-MÌ HYMN COLLECTION

- Nos. 257–77. Described, with citation of some lines, in *JCS* XX 80–81. A critical edition is given above, pp. 45–56.
- No. 257. AbS-T 194 + 295. The last column of this fragment is almost certainly part of the left column of No. 259. See also the description of No. 265.
- No. 258. AbS-T 195.
- No. 259. AbS-T 198. See description of Nos. 257 and 265.
- No. 260. AbS-T 334.
- No. 261. AbS-T 269*b*.
- No. 262. AbS-T 153.
- No. 263. AbS-T 159.
- No. 264. AbS-T 318.
- No. 265. AbS-T 147. It is virtually certain that this fragment is part of No. 259; because of distortion, the physical fit of the two fragments is not perfect, but they fit perfectly into the reconstructed text as a single tablet. On both there is a blank space near the right edge of the reverse. See also No. 257.
- No. 266. AbS-T 196. Photo. The right column on the reverse is insufficiently preserved to include in the critical edition.
- No. 267. AbS-T 191. Photo of the obverse, autograph copy of the reverse. Five very small fragments (not catalogued separately), probably from this tablet, are omitted. Except for the sign NAGAR on one fragment and zà-mì preserved or restorable on others, they are illegible.
- No. 268. AbS-T 192. Autograph copy of the obverse, photo of the reverse.
- No. 269. AbS-T 193 + 371.
- No. 270. AbS-T 385.
- No. 271. AbS-T 361.
- No. 272. AbS-T 322.
- No. 273. AbS-T 199.
- No. 274. AbS-T 197.
- No. 275. AbS-T 217*a*. The sequence of columns on the reverse is from left to right. Nos. 276 and 277 are fragments of the same tablet.
- No. 276. AbS-T 217*b*. From the same tablet as No. 275. The fragment belongs to the reverse of the tablet.
- No. 277. AbS-T 217*c*. Same tablet as Nos. 275 and 276. The fragment belongs to the reverse of the tablet. The left column may belong in the damaged section consisting of lines 188–91 of the reconstructed text.

OTHER LITERARY TEXTS

- No. 278. AbS-T 245. Note repeated references to the god Ama-ušumgal, whose name also occurs in SF 78.
- No. 279. AbS-T 256*b*. Exercise tablet. Probably same tablet as No. 280. Column ii of the reverse is probably the same column as the second column from the right on the reverse of No. 280.
- No. 280. AbS-T 256*a*. Exercise tablet. The beginning was cited in *JCS* XX 81. See also No. 279.
- No. 281. AbS-T 257. Photo. Exercise tablet. Cf. Nos. 279 and 280.

- No. 282. AbS-T 281*a*. Some lines were cited in *JCS* XX 81, where the parallels to SF 40 were pointed out. The thickest part of the tablet is approximately in the middle of the design.
- No. 283. AbS-T 279 + 293. Text concerned with Ašnan. Note the standard sequence giš—dug₄, ne—šub_x, “had intercourse, kissed,” for which see Falkenstein, in *ZA* LV (1963) 17. The first lines of the top fragment (AbS-T 293) were cited in *JCS* XX 81, n. 59. The top fragment has been badly smashed. Note the rare sign LAK 173 in column vii. The thickest part of this tablet is at column vi in the first two lines of the lower fragment (AbS-T 279). Duplicates are Nos. 231, 284–96. Wedges belonging to the sign MUNSUB were inadvertently omitted from the copy.
- No. 284. AbS-T 390*b*. See No. 283.
- No. 285. AbS-T 392*g*. See No. 283.
- No. 286. AbS-T 392*e*. See No. 283.
- No. 287. AbS-T 308. See No. 283. The thickest part of the tablet is at the bottom of the preserved portion of column iii.
- No. 288. AbS-T 354*a*. Same composition as No. 283. Nos. 288–93 are fragments of the same tablet as are Nos. 295–96.
- No. 289. AbS-T 354*b* + *e*. See the description of No. 288. It is probable that this fragment belongs directly above the last three columns of No. 288.
- No. 290. AbS-T 354*e*. See the description of No. 288.
- No. 291. AbS-T 354*d*. See the description of No. 288.
- No. 292. AbS-T 354*g*. See the description of No. 288.
- No. 293. AbS-T 354*f*. See the description of No. 288.
- No. 294. AbS-T 403*b*. The fragment does not join No. 283, but it may be the same tablet as No. 288.
- No. 295. AbS-T 387*b*. Same composition as No. 283. From the same tablet as Nos. 288–93. See the description of No. 288.
- No. 296. AbS-T 387*e*. Same composition as No. 283. From the same tablet as Nos. 288–93. See the description of No. 288.
- No. 297. AbS-T 139*d*. The fragment possibly belongs to same composition as Nos. 283–96, but it may also be UD.GAL.NUN.
- No. 298. AbS-T 250. This tablet has suffered severely from flaking and shattering. There are many uncertainties in the copy, despite careful collations of two successive copies with the original in Baghdad. Some of the lines could be taken as personal names.
- No. 299. AbS-T 365.
- No. 300. AbS-T 373. Possibly UD.GAL.NUN.
- No. 301. AbS-T 351*a*. Note Ašgi (^ašAR × DIŠ-gi₄) in column iii. The following line is perhaps restorable from No. 41 iii 3.
- No. 302. AbS-T 329.
- No. 303. AbS-T 376*a*.
- No. 304. AbS-T 377*b*.
- No. 305. AbS-T 352.
- No. 306. AbS-T 377*a*. Perhaps UD.GAL.NUN.

Nos. 307–11. Fragments of the Kesh Temple Hymn, of which the Old Babylonian version was edited by G. Gragg, in *TCS* III 165–88. An edition of these fragments has been given by Biggs, in *ZA* LXI 193–207.

- No. 307. AbS-T 284.
- No. 308. AbS-T 302. Unlike most tablets from Abū Ṣalābīkh, this one does not have a separate surface layer (see p. 22). In obverse column ii, it is not absolutely certain that the signs are du_7-du_7 and not $gud\ gud$.
- No. 309. AbS-T 89*a*.
- No. 310. AbS-T 89*b*.
- No. 311. AbS-T 347.
- No. 312. AbS-T 409*b*.
- No. 313. AbS-T 120.
- No. 314. AbS-T 236*c*. Not collated.
- No. 315. AbS-T 392*c*.
- No. 316. AbS-T 68. Possibly a list of gods rather than a literary text.
- No. 317. AbS-T 397.
- No. 318. AbS-T 226. Exercise tablet. It is perhaps to be considered an UD.GAL.NUN text. The deity in the first line should probably be read ${}^a r\check{s}\check{A}R \times DI\check{s}^1-gi$, i.e., Ašgi.
- No. 319. AbS-T 169. Exercise tablet. Possibly ${}^a Nin.A.BU.ĦA.DU$ is to be restored in col. iii l. 1.
- No. 320. AbS-T 48. Exercise tablet. Reverse. The obverse is entirely destroyed.
- No. 321. AbS-T 187. Exercise tablet. It is perhaps a word list rather than a literary text. Note the writing for $giri-zal$ in obv. iii 4, pointed out in ZA LXI 206.
- No. 322. AbS-T 263. The tablet consists of pieces joined back to back. Cf. No. 336.
- No. 323. AbS-T 305. This may be the same tablet as No. 254 (considered to be UD.GAL.NUN), but note that this fragment has the sign NAM , not attested in any UD.GAL.NUN text which has been identified with certainty (but see No. 243).
- No. 324. AbS-T 101. Duplicate of TSS 126. See also No. 325. Parts of the fragment are extremely difficult to read, and the copy is correspondingly unreliable.
- No. 325. AbS-T 233. Duplicate of TSS 126 with numerous variants. Comparison with TSS 126 suggests that the side copied here is the reverse of the tablet and that the sequence of columns is left to right. (The other side has only slight traces of writing remaining.) The right side of this fragment has been badly smashed by another tablet. A jar spout (catalogued as AbS 377) has caused a deep hole. See No. 324.
- No. 326. AbS-T 227. This tablet is one of the most nearly intelligible of the literary texts. A few lines have been cited in RA LX 175–76, n. 6. Note the use of \dot{u} , “and,” in col. ii l. 12. No other texts in this volume were copied by the scribe of this tablet. The tablet is not formed of a separate core and surface layer as are most Abū Ṣalābīkh literary and lexical tablets.
- No. 327. AbS-T 171. Exercise tablet; myth about Lugalbanda and Nin-sún. See JCS XX 85. Photos are published here in addition to the autograph copy.
- No. 328. AbS-T 359. Probably literary. There are some very light random lines on the reverse.
- No. 329. AbS-T 280. Note Enki in column ii and also en-Kullaba in column vi.
- No. 330. AbS-T 167. Exercise tablet. Photos.
- No. 331. AbS-T 216. Although the tablet is rectangular in form, the script suggests that it was written by an inexperienced scribe.
- No. 332. AbS-T 262. Cf. Nos. 333 and 423.
- No. 333. AbS-T 390*a*. Cf. No. 332.
- No. 334. AbS-T 337.
- No. 335. AbS-T 320*a*.

- No. 336. AbS-T 327. Cf. No. 322 reverse.
- No. 337. AbS-T 37.
- No. 338. AbS-T 389*a*. The writing closely resembles No. 339; the fragments are probably part of the same tablet.
- No. 339. AbS-T 370. The right column is near the right edge of the tablet and may be the last column. See No. 338.
- No. 340. AbS-T 178. It is doubtful that the fragment copied as the last line of column i belongs to this tablet.
- No. 341. AbS-T 346. Probably literary. Note mention of Ur and Kesh.
- No. 342. AbS-T 306. The text ends ^aUtu zà-mì. See the description of No. 142 for parallels. Beginning of colophon (Û-[NE.NE]) in the last column.
- No. 343. AbS-T 71. Possibly UD.GAL.NUN.
- No. 344. AbS-T 16*a*.
- No. 345. AbS-T 15. Partly quoted in *JCS* XX 84, n. 85.
- No. 346. AbS-T 18. Final line of a text. Probably read ^aEn-l[il] z[à]-mì. See the description of No. 142 for parallels.
- No. 347. AbS-T 20. Beginning of a text probably concerned with Enlil or Enki.
- No. 348. AbS-T 25. Possibly UD.GAL.NUN.
- No. 349. AbS-T 24.
- No. 350. AbS-T 391.
- No. 351. AbS-T 26. Possibly UD.GAL.NUN. Note zà-mì.
- No. 352. AbS-T 22.
- No. 353. AbS-T 39. Cf. *dím sa-ak* in Gudea Cyl. B xvi 6.
- No. 354. AbS-T 50.
- No. 355. AbS-T 42.
- No. 356. AbS-T 51*a*. Note ^aSùd and Shuruppak in column iii.
- No. 357. AbS-T 66.
- No. 358. AbS-T 51*b*.
- No. 359. AbS-T 67.
- No. 360. AbS-T 54.
- No. 361. AbS-T 53.
- No. 362. AbS-T 73.
- No. 363. AbS-T 76.
- No. 364. AbS-T 85.
- No. 365. AbS-T 86*a*.
- No. 366. AbS-T 86*b*.
- No. 367. AbS-T 86*c*.
- No. 368. AbS-T 96.
- No. 369. AbS-T 90. Probably bottom line or next to bottom line. Cf. No. 373.
- No. 370. AbS-T 89*c*.
- No. 371. AbS-T 98. Probably the same tablet as No. 376.
- No. 372. AbS-T 104.
- No. 373. AbS-T 105. Cf. No. 369.

- No. 374. AbS-T 108. Cf. No. 377.
 No. 375. AbS-T 113.
 No. 376. AbS-T 126. Probably the same tablet as No. 371.
 No. 377. AbS-T 114. Cf. No. 374.
 No. 378. AbS-T 127.
 No. 379. AbS-T 116. Possibly a word list.
 No. 380. AbS-T 149. Possibly a word list.
 No. 381. AbS-T 172. Note ama nu-g[ig] in column ii.
 No. 382. AbS-T 112.
 No. 383. AbS-T 150.
 No. 384. AbS-T 154. Note the mention of Kullaba.
 No. 385. AbS-T 111. The obverse(?) is extremely difficult to read; the traces on the reverse(?) are illegible. Possibly UD.GAL.NUN (cf. SF 37).
 No. 386. AbS-T 161.
 No. 387. AbS-T 170.
 No. 388. AbS-T 355. The surface of the obverse is badly shattered. There are a number of uncertainties in the copy. The colophon is left of the center of the tablet. The thickest part is approximately one inch to the right of the bottom ruling of the colophon. The text ends ⁴Inanna zà-mì. See the description of No. 142 for parallels.
 No. 389. AbS-T 252. Note remains of the u₄-ri-šè formula in column i.
 No. 390. AbS-T 36.
 No. 391. AbS-T 140. Note that this tablet is earlier than the other literary texts published in this volume.
 No. 392. AbS-T 44a. Previously published, in a preliminary copy, in *JCS* XX 79, Fig. 2, with AbS-T 44b-f. Note occurrences of má-gur₈ in this fragment. Nos. 393-97 are from the same tablet.
 No. 393. AbS-T 44b. See the description of No. 392.
 No. 394. AbS-T 44c. See the description of No. 392.
 No. 395. AbS-T 44e. See the description of No. 392.
 No. 396. AbS-T 44f. See the description of No. 392.
 No. 397. AbS-T 44d. See the description of No. 392.

MISCELLANEOUS LITERARY AND LEXICAL FRAGMENTS

- No. 398. AbS-T 389f. Possibly a fragment of a colophon.
 No. 399. AbS-T 389e. Probably UD.GAL.NUN.
 No. 400. AbS-T 131. Judging from the thickness of the wedges in the first line of column ii, the sign is probably MÈ.
 No. 401. AbS-T 389j.
 No. 402. AbS-T 389i. Cf. perhaps Nos. 436 and 459.
 No. 403. AbS-T 389h. Cf. Zà-mì Hymns line 219.
 No. 404. AbS-T 389k. Probably word list.
 No. 405. AbS-T 389l.
 No. 406. AbS-T 390c. Perhaps UD.GAL.NUN.

- No. 407. AbS-T 389*m*.
 No. 408. AbS-T 392*k*.
 No. 409. AbS-T 392*i*.
 No. 410. AbS-T 392*b*.
 No. 411. AbS-T 392*l*.
 No. 412. AbS-T 392*n*.
 No. 413. AbS-T 403*c*.
 No. 414. AbS-T 406.
 No. 415. AbS-T 366. Written in an awkward script.
 No. 416. AbS-T 367.
 No. 417. AbS-T 372*b*. Perhaps UD.GAL.NUN.
 No. 418. AbS-T 374. Not collated.
 No. 419. AbS-T 382.
 No. 420. AbS-T 387*a*. Possibly a colophon.
 No. 421. AbS-T 383.
 No. 422. AbS-T 387*c*.
 No. 423. AbS-T 387*d*. Cf. No. 332.
 No. 424. AbS-T 388*a*. Perhaps a word list. It is not certain that the vertical line before $\text{U}^{\text{TIR}}_{\text{TIR}}$ is a ruling rather than a vertical wedge.
 No. 425. AbS-T 388*b*.
 No. 426. AbS-T 138. Perhaps a word list.
 No. 427. AbS-T 139*b*. Probably UD.GAL.NUN. Cf. No. 124 obv. iv.
 No. 428. AbS-T 320*b*.
 No. 429. AbS-T 139*f*.
 No. 430. AbS-T 236*b*.
 No. 431. AbS-T 174. Cf. *OIP* XIV, No. 196.
 No. 432. AbS-T 317*c*. The fragment is very difficult to read. There is perhaps a ruling above NE in column i.
 No. 433. AbS-T 317*f*. Perhaps from same tablet as No. 98.
 No. 434. AbS-T 317*g*.
 No. 435. AbS-T 317*d*.
 No. 436. AbS-T 351*b*. Cf. Nos. 459 and 402.
 No. 437. AbS-T 356.
 No. 438. AbS-T 326. Poorly written, washed-out fragment. Perhaps a word list.
 No. 439. AbS-T 335. Cf. Professions List, lines 56–57 (*MSL* XII 17).
 No. 440. AbS-T 328. The signs in the top line are probably KU-KU.
 No. 441. AbS-T 49.
 No. 442. AbS-T 125.
 No. 443. AbS-T 45*k*.
 No. 444. AbS-T 123. Poorly written fragment.
 No. 445. AbS-T 70. Perhaps a word list.
 No. 446. AbS-T 58.
 No. 447. AbS-T 129. Perhaps a word list.

FRAGMENTS OF COLOPHONS

95

- No. 448. AbS-T 119.
 No. 449. AbS-T 130. Exercise tablet(?).
 No. 450. AbS-T 403*g*.
 No. 451. AbS-T 403*f*.
 No. 452. AbS-T 403*d*. Not collated.
 No. 453. AbS-T 238*d*.
 No. 454. AbS-T 389*n*.
 No. 455. AbS-T 33*c*. Probably word list or sign list.
 No. 456. AbS-T 409*a*.
 No. 457. AbS-T 392*u*. The right column is perhaps part of a colophon.

EXERCISE TABLETS

- No. 458. AbS-T 162.
 No. 459. AbS-T 332. Obverse. The reverse is obliterated except for a few traces of signs and numbers (not copied). Cf. Nos. 402 and 436.
 No. 460. AbS-T 5. Photo. Exercises partly obliterated.
 No. 461. AbS-T 183. Photo.
 No. 462. AbS-T 184. Photo.
 No. 463. AbS-T 188. Photo. See comment on the names of cities on the obverse in *JCS* XX 77, n. 32; also pp. 23–24 above.
 No. 464. AbS-T 182. Very crude writing.
 No. 465. AbS-T 386.
 No. 466. AbS-T 158. The tablet is somewhat asymmetrical.
 No. 467. AbS-T 175. The writing is very awkward.
 No. 468. AbS-T 134.
 No. 469. AbS-T 132.
 No. 470. AbS-T 157. The reverse was pared off.
 No. 471. AbS-T 136.

FRAGMENTS OF COLOPHONS

- No. 472. AbS-T 394. No verticals are visible in the sign below ti in column i, so the name is perhaps not 𒄩u-ti-um.
 No. 473. AbS-T 46. The identification as a colophon is based on the possible restorations GAL + [LÚ]-kisal-si, En-[na-il].
 No. 474. AbS-T 38.
 No. 475. AbS-T 107.
 No. 476. AbS-T 395.
 No. 477. AbS-T 60.
 No. 478. AbS-T 124. The first name appears to be [Ku-l]i, although Ku-li is also in line 4.
 No. 479. AbS-T 399.
 No. 480. AbS-T 43.
 No. 481. AbS-T 396. Awkward writing. The small wedges are only strokes without “heads.”

- No. 482. AbS-T 411. From the middle of a tablet reverse.
 No. 483. AbS-T 215 reverse. The final column of the text itself (see No. 1) has not been copied.
 No. 484. AbS-T 408.
 No. 485. AbS-T 317*b*.
 No. 486. AbS-T 16*b*.
 No. 487. AbS-T 214 reverse. The final column of the text (see No. 1) has not been copied.
 No. 488. AbS-T 400. There is a large uninscribed area above the colophon.
 No. 489. AbS-T 21.

ADMINISTRATIVE TABLETS

- No. 490. AbS-T 80. Photo. List of workmen belonging to various professions. Cited in full in *JCS* XX 85 and 87.
 No. 491. AbS-T 78. Photo. Deals principally with draft oxen and draft asses, grain to feed them, and seed grain. Note the form of the sign ANŠE in this text and Nos. 492, 494, and 496.
 No. 492. AbS-T 79. Photo. Deals with barley for asses.
 No. 493. AbS-T 2. Photo. Only reverse preserved. Deals with fields.
 No. 494. AbS-T 14. Photo. Published with photo and transliteration, *JCS* XX 86–88. Concerns barley for the asses of the king(?) (lugal) and rations for the slaves (še-ba-arad₂).
 No. 495. AbS-T 9. Photo. Deals with barley.
 No. 496. AbS-T 3. Fragment of reverse.
 No. 497. AbS-T 4. The summary has x iku (of land).
 No. 498. AbS-T 7. Designation of obverse and reverse not quite certain; contents uncertain.
 No. 499. AbS-T 8*a*. The preserved part of the reverse is uninscribed. Probably refers to distribution of land.
 No. 500. AbS-T 8*b*. Clearly še-gur rather than še-gán in column i.
 No. 501. AbS-T 17. Only reverse preserved. Receipt for 39 copper lance tips. Cited in *JCS* XX 87, n. 108.
 No. 502. AbS-T 10. Deals with barley and jugs (of beer?) and quantities of copper.
 No. 503. AbS-T 12. Deals with barley and fields. Note some Semitic names. Note also that the sign ANŠE in ANŠE.BAR.AN has a form different from ANŠE in Nos. 491, 492, 494, 496, and 507.
 No. 504. AbS-T 11. Deals with še-gán. See *JCS* XX 88.
 No. 505. AbS-T 95. Small fragment from a large tablet. Note lugal-Ereš on the reverse. A Semitic name (I-k[u](?)-i-sar) occurs on the obverse. Deals with rations.
 No. 506. AbS-T 83. Deals with prebend land (še-gán šuĜ). Note a possibly Semitic name Ū-aš-dar on the obverse, and perhaps read 'I-ku'-[gu-il] in column iii.
 No. 507. AbS-T 181 reverse. Obverse illegible. Deals with grain. Note the difference between the sign ANŠE in column ii and in ANŠE.BAR.AN in column i and further that it differs from the occurrence of ANŠE.BAR.AN in No. 503.
 No. 508. AbS-T 186. Deals with še-gán. I have assumed the side with AN.ŠE.ĜÚ, "total," to be the reverse, even though it is the flatter side of the tablet. See discussion above on p. 44, also, for the possibility that this text is written in Akkadian.
 No. 509. AbS-T 179. Small fragment of reverse. The verticals are made without a distinct "head" to the wedges.

ADMINISTRATIVE TABLETS

97

- No. 510. AbS-T 47. Deals with cows. Note Bar^{kl} on the reverse and also on obverse column ii, and cf. uru-bar^{kl} in No. 503 col. viii.
- No. 511. AbS-T 189. Deals with še-gán. Perhaps the name A-x-pa-bàb is Semitic (see p. 34, n. 32). Cf. No. 495. Note the geographical name Lál-la-ad^{kl}.
- No. 512. AbS-T 185. Deals with emmer and barley.
- No. 513. AbS-T 229. Note the Semitic names.
- No. 514. AbS-T 345. In line 1 probably restore the name šeš. [kl]-na.
- No. 515. AbS-T 180. The reverse (not copied) has only 1 gala preserved.

INDEX OF FIELD NUMBERS

ALL the tablets are in the Iraq Museum. Museum numbers are given for those that have been accessioned. All others are designated "for study" in the museum registers. The dimensions are given in centimeters, in the sequence height, width, and thickness. All figures are maximum. In the case of fragments rejoined after cataloguing, the dimensions are those of the fragment as catalogued. All tablets were found in Area E (see ch. 1). "Level I fill" refers to material in the top level, but not associated with a floor (i.e., it was deposited after the time when the floor was in use). "Cut" refers to intrusive holes, pits, and the like.

Use of the letters *a*, *b*, *c*, etc., with field numbers does not imply any relationship among the fragments unless the contrary is specifically stated in the Catalogue of Published Texts.

| FIELD NUMBER | PUBLICATION NUMBER | MUSEUM NUMBER | DIMENSIONS | FINDSPOT |
|-----------------|--------------------|---------------|-----------------|---|
| AbS-T 1 | 1, 2 | IM 67639 | 14 × 11.1 × 3.4 | Room 3, Level I fill |
| 2 | 493 | IM 67640 | 5.3 × 6 × 2.2 | " |
| 3 | 496 | | 5.8 × 3.8 × 2.9 | " |
| 4 | 497 | | 2.6 × 4.4 × 1.9 | " |
| 5 | 460 | IM 67641 | 6.2 × 8 × 3.1 | " |
| 6 ¹ | | | 5.4 × 3.7 × 1.8 | " |
| 7 | 498 | | 2.9 × 3.1 × 1.5 | " |
| 8 _a | 499 | | 5 × 2.9 × 2.4 | " |
| 8 _b | 500 | | 2.7 × 2.8 × 2.6 | " |
| 9 | 495 | IM 67642 | 8.6 × 8.9 × 2.4 | Room 8, Level I fill |
| 10 | 502 | IM 67643 | 6.9 × 7.4 × 2.5 | Room 15, cut in Level I |
| 11 | 504 | IM 67644 | 6.3 × 6.3 × 2.3 | " |
| 12 | 503 | IM 67645 | 8.1 × 8 × 3.1 | Room 5, cut in Level I |
| 13 | 194 | | 5.3 × 7.3 × 1.2 | Room 11, Level I fill |
| 14 | 494 | IM 67646 | 7.5 × 7.5 × 2.5 | Room 6, Level I, 10 cm. above the floor |
| 15 | 345 | | 5.8 × 3.6 × 2.3 | Room 20, cut in Level I |
| 16 _a | 344 | | 3.1 × 2.5 × 0.7 | " |
| 16 _b | 486 | | 2.9 × 1.6 × 3 | " |
| 17 | 501 | | 4.2 × 4.6 × 2.2 | " |
| 18 | 346 | | 4.4 × 2.6 × 1.5 | " |
| 19 | 195 | | 6.2 × 6.4 × 2.6 | " |
| 20 | 347 | | 5.6 × 6 × 3.2 | " |
| 21 | 489 | | 8.5 × 5.8 × 4.6 | " |
| 22 | 352 | | 3.8 × 6.3 × 3.5 | " |
| 23 ² | | | 4.9 × 8.4 × 2.9 | " |
| 24 | 349 | | 4.1 × 4.2 × 1.6 | " |
| 25 | 348 | | 5 × 3.6 × 1.4 | " |
| 26 | 351 | | 4.8 × 1.6 × 3.4 | " |
| 27 | 196 | | 5.8 × 6.5 × 2.8 | " |

1. Unpublished. Fragment with one illegible sign on the reverse.

2. Unpublished. Fragment of a lexical or literary text with traces of several signs.

INDEX OF FIELD NUMBERS

| FIELD NUMBER | PUBLICATION NUMBER | MUSEUM NUMBER | DIMENSIONS | FINDSPOT |
|--------------|--------------------|---------------|-------------------|-------------------------|
| AbS-T 28 | 235 | | 3.8 × 3.7 × 1.8 | Room 20, cut in Level I |
| 29a | 238 | | 7.8 × 5.5 × 2 | " |
| 29b | 239 | | 5.1 × 3.6 × 1.5 | " |
| 29c | 243 | | 4.6 × 4.5 × 1.6 | " |
| 29d | 247 | | 7.5 × 5.5 × 2.1 | " |
| 29e | 244 | | 2.4 × 4 × 1.3 | " |
| 29f | 240 | | 3.7 × 3.2 × 0.9 | " |
| 29g | 245 | | 4.8 × 2 × 1 | " |
| 29h | 242 | | 2.8 × 2 × 0.8 | " |
| 29i | 241 | | 3.7 × 3.5 × 1.1 | " |
| 29j | 246 | | 4.2 × 2.4 × 1.1 | " |
| 30 | 224 | | 6.7 × 11.9 × 4 | " |
| 31 | 224 | | 5.2 × 4.1 × 2.1 | " |
| 32 | 236 | | 6.2 × 2.6 × 2.3 | " |
| 33a | 127 | IM 67647 | 11.5 × 9.5 × 1.3 | " |
| 33b | 125 | | 8.8 × 6.8 × 1.5 | " |
| 33c | 455 | | 2.6 × 3.1 × 1.2 | " |
| 34 | 227 | | 7.2 × 6 × 2.9 | " |
| 35 | 189 | | 6.5 × 7.1 × 3.1 | " |
| 36 | 390 | | 2.1 × 4 × 2.5 | " |
| 37 | 337 | | 4.2 × 5.8 × 0.8 | " |
| 38 | 474 | | 4.5 × 4.7 × 1.3 | " |
| 39 | 353 | | 3.9 × 3.8 × 1.8 | " |
| 40 | 191 | | 4.3 × 4.4 × 2 | " |
| 41 | 216 | | 3.5 × 2.6 × 1.7 | " |
| 42 | 355 | | 3.2 × 3.5 × 1 | " |
| 43 | 480 | | 6.6 × 5.2 × 3.1 | " |
| 44a | 392 | IM 67648 | 8 × 13.4 × 1.6 | " |
| 44b | 393 | | 4.7 × 5.7 × 1.4 | " |
| 44c | 394 | | 4.6 × 4.3 × 1.2 | " |
| 44d | 397 | | 5.4 × 3.1 × 1.4 | " |
| 44e | 395 | | 4 × 3.3 × 0.9 | " |
| 44f | 396 | | 4.1 × 2.8 × 1.2 | " |
| 45a | 103 | | 9.1 × 11.9 × 3 | " |
| 45b | 100 | | 5.4 × 4 × 1.3 | " |
| 45c | 108 | | 5.5 × 5.1 × 1.3 | " |
| 45d | 111 | | 3.4 × 3.7 × 1.4 | " |
| 45e | 202 | | 5.2 × 4.4 × 2.5 | " |
| 45f | 105 | | 4.3 × 3.4 × 1.5 | " |
| 45g | 101 | | 4.1 × 5.5 × 2.1 | " |
| 45h | 110 | | 4.3 × 5 × 2 | " |
| 45i | 109 | | 4 × 4 × 1.5 | " |
| 45j | 107 | | 9.4 × 6.8 × 3 | " |
| 45k | 443 | | 2.7 × 3.7 × 1.2 | " |
| 45l | 111 | | 4.4 × 3.4 × 3 | " |
| 45m | 102 | | 4 × 5.3 × 1.4 | " |
| 45n | 104 | | 3.9 × 5 × 2.1 | " |
| 45o | 106 | | 5.2 × 4.4 × 1.9 | " |
| 46 | 473 | | 10.9 × 13.5 × 3.3 | " |
| 47 | 510 | IM 67649 | 3.7 × 3.7 × 2.1 | Room 21, cut in Level I |
| 48 | 320 | IM 67650 | 6.7 × 5.9 × 2.6 | " |
| 49 | 441 | | 3.2 × 5.1 × 1 | " |
| 50 | 354 | | 4.5 × 3.9 × 1.7 | " |
| 51a | 356 | | 6.8 × 7 × 3.5 | " |
| 51b | 358 | | 2.8 × 3.6 × 1.2 | " |

INDEX OF FIELD NUMBERS

| FIELD NUMBER | PUBLICATION NUMBER | MUSEUM NUMBER | DIMENSIONS | FINDSPOT |
|------------------------------|--------------------|---------------|-------------------|-------------------------|
| AbS-T 52 | 213 | | 7.6 × 5.1 × 1.9 | Room 21, cut in Level I |
| 53 | 361 | | 6.3 × 6.4 × 2.3 | " |
| 54 | 360 | | 3.7 × 6.4 × 1.1 | " |
| 55 | 112 | | 5.5 × 4.7 × 1.3 | " |
| 56 | 159 | | 7.6 × 6 × 3.9 | " |
| 57 | 190 | | 3.6 × 4.9 × 3.1 | " |
| 58 | 446 | | 2.8 × 6.4 × 3.6 | " |
| 59 | 193 | | 5.5 × 3.9 × 1.8 | " |
| 60 | 477 | | 5.2 × 2.7 × 1.7 | " |
| 61 | 161 | | 7 × 6.4 × 3.6 | " |
| 62 | 160 | | 4 × 4.6 × 1.1 | " |
| 63 | 89 | | 5.6 × 5.4 × 1.8 | " |
| 64 | 210 | IM 67651 | 10.6 × 7.4 × 1.6 | " |
| 65 | 145 | | 4.6 × 4.8 × 1.5 | " |
| 66 | 357 | | 4.8 × 4.9 × 2.5 | " |
| 67 | 359 | | 5.3 × 5.6 × 2.9 | " |
| 68 | 316 | | 5.3 × 3.6 × 3.5 | " |
| 69 ³ | | | 3.5 × 4.6 × 1.2 | " |
| 70 | 445 | | 3.5 × 3.6 × 1.7 | " |
| 71 | 343 | | 4.2 × 2.1 × 2.6 | " |
| 72 | 57 | | 3.5 × 5.1 × 1.2 | " |
| 73 | 362 | | 4.6 × 3.9 × 1.3 | " |
| 74 | 143 | | 3.7 × 3.5 × 1.7 | " |
| 75 | 1 | | 1.3 × 6 × 1.8 | " |
| 76 | 363 | | 2.8 × 4.9 × 3.4 | " |
| 77 | 112 | IM 67652 | 11.5 × 12.1 × 3.7 | " |
| 78 | 491 | IM 67653 | 6.1 × 4.1 × 1.3 | Room 8, cut in Level I |
| 79 | 492 | | 5.3 × 4 × 0.9 | " |
| 80 | 490 | IM 67654 | 5.7 × 5.6 × 2 | Room 23, Level I fill |
| 81 | 10 | | 5.5 × 4.3 × 2 | Room 8, Level I fill |
| 82 | 199 | IM 67655 | 11.3 × 10.6 × 3 | Room 9, cut in Level I |
| 83 | 506 | | 5.5 × 5.5 × 2.9 | Room 21, cut in Level I |
| 84 | 185 | | 9.4 × 8.7 × 4.1 | " |
| 85 | 364 | | 6 × 6.2 × 1.9 | " |
| 86 _a | 365 | | 2.2 × 3 × 1.2 | " |
| 86 _b | 366 | | 2 × 2.2 × 1 | " |
| 86 _c | 367 | | 1.6 × 2.7 × 0.9 | " |
| 87 _a | 35 | | 9.1 × 9.4 × 3.3 | " |
| 87 _b | 225 | | 4.7 × 5.9 × 1.1 | " |
| 88 | 182 | | 4.6 × 2.7 × 2.4 | " |
| 89 _a | 309 | | 11.5 × 11.8 × 1.4 | " |
| 89 _b | 310 | | 2 × 2.7 × 1 | " |
| 89 _c | 370 | | 3.1 × 2.5 × 1.6 | " |
| 90 | 369 | | 5.5 × 6.1 × 2.6 | " |
| 91 ⁴ | | | | " |
| 92 | 34 | IM 70304 | 19.5 × 23 × 8.7 | " |
| 93 ⁵ | | | | " |
| 94 _a ⁶ | | | 8.3 × 9.7 × 3.6 | Room 20, cut in Level I |
| 94 _b ⁶ | | | 6.8 × 5.6 × 2.8 | " |
| 95 | 505 | | 8.3 × 5.8 × 3 | Room 11, Level IB fill |
| 96 | 368 | | 4.6 × 6.2 × 2.2 | " |

3. Unpublished. Fragment of a lexical or literary text with several legible signs.

4. Unpublished. Nine very small fragments, each with a sign or two, all worthless.

5. Three undersides of surface layers. See Fig. 24.

6. Unpublished. Two uninscribed reverses of tablets with partially legible impressions made by other tablets.

INDEX OF FIELD NUMBERS

| FIELD NUMBER | PUBLICATION NUMBER | MUSEUM NUMBER | DIMENSIONS | FINDSPOT |
|-------------------|--------------------|---------------|------------------|-------------------------------|
| AbS-T 97 | 198 | | 5.3 × 3 × 1.5 | Room 11, Level <i>IB</i> fill |
| 98 | 371 | | 3.3 × 4.8 × 1.3 | " |
| 99 | 93 | | 5.4 × 2.9 × 1.8 | " |
| 100 | 192 | | 6.4 × 8 × 5.5 | " |
| 101 | 324 | | 7 × 6.4 × 3.2 | " |
| 102 | 1 | | 8.5 × 8.5 × 1.4 | " |
| 103 | 1 | IM 70271 | 5.6 × 8.4 × 3.6 | " |
| 104 | 372 | | 4.5 × 4.3 × 1.2 | " |
| 105 | 373 | | 5.9 × 5.1 × 1.9 | " |
| 106 | 207 | | 4.4 × 5.8 × 2.2 | " |
| 107 | 475 | | 3.4 × 4.7 × 1.5 | " |
| 108 | 374 | | 4.4 × 3.1 × 2.8 | " |
| 109 | 180 | | 3.4 × 10.4 × 4.8 | " |
| 110 | 45 | | 8.5 × 10.3 × 3.4 | " |
| 111 | 385 | | 5.3 × 6.3 × 2.9 | " |
| 112 | 382 | | 4.3 × 3.3 × 2.2 | " |
| 113 | 375 | | 4.6 × 2.7 × 2.7 | " |
| 114 | 377 | | 6 × 4.5 × 2.1 | " |
| 115 | 16 | | 6.9 × 5.4 × 2 | " |
| 116 | 379 | | 4.3 × 2.9 × 2.3 | " |
| 117 | 181 | IM 70272 | 4.1 × 6.6 × 2.2 | " |
| 118 | 15 | | 4.5 × 3.5 × 2.3 | " |
| 119 | 448 | | 3.8 × 3.6 × 2.3 | " |
| 120 | 313 | | 4 × 3.6 × 1.8 | " |
| 121 | 197 | | 5.1 × 5 × 1.9 | " |
| 122 | 212 | | 3.5 × 2.2 × 2.4 | " |
| 123 | 444 | | 1.3 × 4 × 2.9 | " |
| 124 | 478 | | 6.3 × 8.2 × 1.9 | " |
| 125 | 442 | | 1 × 4.3 × 3.6 | " |
| 126 | 376 | | 4 × 3.8 × 1.2 | " |
| 127 | 378 | | 4.3 × 2 × 2.5 | " |
| 128 | 1 | | 1.4 × 5.5 × 2.5 | " |
| 129 | 447 | | 1.5 × 2.2 × 1.9 | " |
| 130 | 449 | | 3.5 × 2.7 × 1.9 | " |
| 131 | 400 | | 2.7 × 3.7 × 0.8 | " |
| 132 | 469 | | 4.7 × 1.7 × 1.8 | " |
| 133 | 32 | IM 70273 | 4.7 × 5 × 2 | " |
| 134 | 468 | | 5.4 × 3.8 × 1.2 | " |
| 135 ^{a7} | | | 4.3 × 5 × 2 | " |
| 135 ^{b7} | | | 3.4 × 2.2 × 1.2 | " |
| 136 | 471 | | 1.3 × 3.6 × 1.3 | " |
| 137 ^a | | | 7.4 × 7 × 3.4 | " |
| 138 | 426 | | 3.3 × 3.1 × 1.1 | " |
| 139 ^a | 97 | | 2.8 × 3.8 × 0.9 | " |
| 139 ^b | 427 | | 2.7 × 2.3 × 1.2 | " |
| 139 ^c | 8 | | 2.1 × 4.1 × 1.2 | " |
| 139 ^d | 297 | | 1.9 × 3.5 × 2.4 | " |
| 139 ^e | 85 | | 1.7 × 2.9 × 0.8 | " |
| 139 ^f | 429 | | 1.8 × 2.5 × 0.7 | " |
| 139 ^g | 36 | | 3.1 × 2.6 × 1.7 | " |
| 139 ^h | 183 | | 2.4 × 2.8 × 1.5 | " |

7. Unpublished. Fragments of an exercise tablet. Most of the writing has been deliberately obliterated. The two fragments were joined back to back by Dr. Abdul Hadi al-Fouadi.

8. Unpublished. Irregular lump of clay with partly obliterated writing exercise.

INDEX OF FIELD NUMBERS

| FIELD NUMBER | PUBLICATION NUMBER | MUSEUM NUMBER | DIMENSIONS | FINDSPOT |
|------------------|--------------------|---------------|-------------------|---|
| AbS-T 140 | 391 | | 8.4 × 6.3 × 2.8 | Room 44, Level IC, floor 2 |
| 141 | 18 | IM 70258 | 12.4 × 13 × 2.5 | " |
| 142 | 19 | | 2.5 × 3 × 1 | " |
| 143 | 5 | | 15 × 14.5 × 3 | " |
| 144a | 1, 3 | | 8.2 × 15 × 2.5 | " |
| 144b | 1, 3 | IM 70274 | 7.7 × 7 × 2 | " |
| 145 | 4 | | 5.7 × 10.8 × 4.2 | " |
| 146 | 152 | IM 70259 | 9.5 × 13.2 × 4.1 | Room 31, Level IB fill by west wall north of door to room 27 |
| 147 | 265 | IM 70260 | 13.5 × 11.5 × 4.7 | " |
| 148 | 188 | IM 70276 | 12.4 × 13.3 × 4.3 | Room 21, cut in Level I |
| 149 | 380 | | 3.3 × 5.3 × 4.2 | " |
| 150 | 383 | | 4.2 × 3.5 × 3.1 | Room 31, Level IB fill near west wall. |
| 151 | 6 | | 6.2 × 4.4 × 2.5 | Room 31, Level IB fill, center of room about 8 ft. from north wall |
| 152 | 29 | | 7.1 × 6 × 2.6 | " |
| 153 | 262 | | 3.8 × 4.5 × 2.3 | " |
| 154 | 384 | | 4.2 × 6.1 × 1.7 | " |
| 155 | 157 | | 4.1 × 5.5 × 3 | " |
| 156 | 228 | | 4.8 × 8.7 × 2.9 | " |
| 157 | 470 | IM 70261 | 4.2 × 4.8 × 1.7 | Room 31, Level IB fill near west wall; about 1/2 in. from a piece of clay with impression of cloth (at same height in lump of earth) (AbS 378, see Fig. 26) |
| 158 | 466 | | 6 × 6 × 3.7 | Room 31, Level IB fill, south center |
| 159 | 263 | | 3.1 × 1.3 × 1.9 | " |
| 160 ⁹ | | | 4 × 3.7 × 1.5 | " |
| 161 | 386 | | 4 × 4.5 × 0.9 | " |
| 162 | 458 | | 4.5 × 3 × 1.3 | Room 31, Level IB fill near west wall about 1 m. north of door near tablet hoard |
| 163 | 37 | | 5.6 × 4.5 × 2.6 | " |
| 164 | 67 | | 3 × 2.8 × 1.1 | " |
| 165 | 31 | | 5.2 × 2.8 × 1.3 | " |
| 166 | 80 | | 4.2 × 3 × 1.7 | " |
| 167 | 330 | IM 70262 | 7.9 × 7.6 × 2.3 | " |
| 168 ⁹ | | | 3.7 × 4.7 × 2.2 | " |
| 169 | 319 | | 7.1 × 5.5 × 2.5 | Room 38, Level IB fill near southwest corner |
| 170 | 387 | IM 70207 | 6.3 × 11.1 × 2.8 | Room 21, cut in Level I |
| 171 | 327 | IM 70263 | 9 × 8.8 × 3.1 | Room 31, Level IB fill near west wall |
| 172 | 381 | | 4.3 × 5.2 × 1.7 | Room 31, Level IB fill, middle of room |
| 173 | 215 | | 4.2 × 1.5 × 1.6 | " |
| 174 | 431 | | 4.4 × 4.1 × 1.4 | Room 31, Level IB fill near center |
| 175 | 467 | | 4.3 × 6.4 × 1.9 | " |
| 176 | 184 | | 2.4 × 3.9 × 1.6 | Room 31, Level IB fill, center of room about 8 ft. from north wall |
| 177 | 229 | | 4.9 × 4.9 × 2.3 | " |
| 178 | 340 | IM 70277 | 6.7 × 9.9 × 2.2 | " |
| 179 | 509 | | 2.1 × 3.2 × 1.7 | Room 37, Level I fill |
| 180 | 515 | | 2.7 × 2.2 × 1.9 | Room 29, Level IA fill |
| 181 | 507 | | 4.6 × 3.8 × 2.5 | Room 39, Level IC fill above floor 2 at face of cast wall south of door |

9. Unpublished. Lump of clay with obliterated writing exercise.

INDEX OF FIELD NUMBERS

103

| FIELD NUMBER | PUBLICATION NUMBER | MUSEUM NUMBER | DIMENSIONS | FINDSPOT |
|--------------------------------|--------------------|---------------|-------------------|--|
| AbS-T 182 | 464 | | 3 × 3 × 1.4 | Room 39, Level IB fill, southwest corner |
| 183 | 461 | IM 70264 | 8.8 × 7.2 × 2.2 | Room 31, cut in Level I |
| 184 | 462 | IM 70182 | 7.9 × 7.9 × 1.9 | " |
| 185 | 512 | IM 70265 | 4.1 × 4.1 × 2.3 | " |
| 186 | 508 | | 5.8 × 7.2 × 2.5 | Room 31, cut in Level I, on top near south wall |
| 187 | 321 | IM 70266 | 7.2 × 8 × 2.3 | " |
| 188 | 463 | IM 70267 | 9.5 × 10 × 2.8 | Room 31, cut in Level I |
| 189 | 511 | | 5.5 × 10 × 2.6 | " |
| 190 ¹⁰ | | | 6.7 × 6.5 × 3 | " |
| 191 | 267 | IM 70268 | 21.8 × 23.2 × 5.2 | " |
| 192 | 268 | IM 70269 | 22.5 × 21.2 × 5 | " |
| 193 | 269 | IM 70270 | 15.4 × 17.4 × 4.3 | " |
| 194 | 257 | IM 70194 | 11.8 × 15.2 × 4.4 | " |
| 195 | 258 | | 10.4 × 12.1 × 4.9 | " |
| 196 | 266 | IM 70154 | 20.4 × 15.4 × 4.5 | " |
| 197 | 274 | IM 70278 | 10.8 × 9.4 × 4.3 | " |
| 198 | 259 | IM 70280 | 13 × 11.6 × 4.5 | " |
| 199 | 273 | | 8.3 × 5.5 × 2.6 | " |
| 200 | 82 | | 4.5 × 4.3 × 1.4 | Room 31, cut in Level I, among bones and sherds around AbS-T 358 |
| 201 | 91 | IM 70155 | 14.4 × 15.6 × 4.5 | Room 31, cut in Level I |
| 202 | 94 | IM 70156 | 13.1 × 11.2 × 3.5 | " |
| 203 | 95 | IM 70281 | 8.4 × 7.4 × 5.1 | " |
| 204 | 92 | | 3 × 4 × 1.3 | " |
| 205 | 96 | IM 70282 | 10.5 × 11.3 × 4.6 | " |
| 206 | 83 | IM 70208 | 16.5 × 13.9 × 4.5 | " |
| 207 | 82 | IM 70158 | 27.3 × 18 × 6 | " |
| 208 | 86 | IM 70157 | 11.4 × 15.2 × 4 | " |
| 209 | 84 | IM 70283 | 11.8 × 10 × 4.2 | " |
| 210 | 83 | | 4.9 × 4.5 × 3.2 | " |
| 211 | 90 | | 3.6 × 3.9 × 1.5 | " |
| 212 _a | 88 | | 2.2 × 3.5 × 1.5 | " |
| 212 _b ¹¹ | 87 | | | " |
| 213 | 1 | IM 70159 | 14.4 × 8.3 × 3.4 | " |
| 214 | 1, 487 | IM 70284 | 11.3 × 12 × 3 | " |
| 215 | 1, 483 | IM 70160 | 14.4 × 16 × 3.7 | " |
| 216 | 331 | | 8.5 × 11 × 2.8 | " |
| 217 _a | 275 | | 11.6 × 8 × 3.9 | " |
| 217 _b | 276 | | 4.3 × 3.3 × 2 | " |
| 217 _c | 277 | | 4 × 2 × 1.7 | " |
| 218 | 255 | IM 70161 | 18 × 18.6 × 3.5 | " |
| 219 | 23 | IM 70162 | 17.8 × 17.7 × 4.5 | " |
| 220 | 120 | IM 70163 | 18.8 × 28 × 5.3 | " |
| 221 | 46 | IM 70164 | 12.8 × 26 × 5.4 | " |
| 222 | 47 | IM 70165 | 17.7 × 27.5 × 6.8 | " |
| 223 | 53 | IM 70166 | 11.6 × 16.4 × 4.1 | " |
| 224 | 48 | IM 70167 | 13.4 × 16.2 × 5.6 | " |
| 225 | 52 | | 5.6 × 4.8 × 2.7 | " |
| 226 | 318 | IM 70168 | 7.4 × 8 × 2.5 | " |
| 227 | 326 | IM 70169 | 19.3 × 12.1 × 3.5 | " |
| 228 | 116 | IM 70206 | 26.5 × 26.8 × 6.5 | " |

10. Unpublished. Administrative tablet, destroyed except for a few signs.

11. Not measured.

INDEX OF FIELD NUMBERS

| FIELD NUMBER | PUBLICATION NUMBER | MUSEUM NUMBER | DIMENSIONS | FINDSPOT |
|--------------------|--------------------|---------------|-------------------|--|
| AbS-T 229 | 513 | | 5.2 × 5.7 × 2.7 | Room 31, cut in Level I |
| 230 | 61 | IM 70170 | 23.2 × 24 × 5 | " |
| 231 | 55 | | 23.2 × 11.5 × 5.2 | " |
| 232a | 54 | IM 70293 | 21 × 21.7 × 4.2 | " |
| 232b | 54 | | 7.7 × 3.1 × 1.6 | " |
| 232c | 56 | | 7.6 × 5.2 × 2 | " |
| 232d ¹¹ | 63 | | | " |
| 232e ¹¹ | 54 | | | " |
| 232f ¹¹ | 54 | | | " |
| 233 | 325 | | 17.5 × 12.5 × 3.8 | Room 31, cut in Level I, smashed together with AbS-T 254 and AbS-T 302 |
| 234 | 62 | IM 70285 | 13.2 × 10 × 4.5 | Room 31, cut in Level I |
| 235 | 60 | IM 70171 | 21.5 × 23.3 × 5.6 | " |
| 236a | 69 | IM 70286 | 13.9 × 17.5 × 6.2 | " |
| 236b | 430 | | 2.9 × 2.5 × 1.4 | " |
| 236c | 314 | | 1.8 × 2.1 × 1.2 | " |
| 237a | 65 | | 11.1 × 16.2 × 4.4 | " |
| 237b | 76 | | 3 × 4.5 × 1.6 | " |
| 238a | 74 | | 14 × 28 × 6.8 | " |
| 238b | 51 | | 3.5 × 4 × 1.3 | " |
| 238c | 50 | | 2.8 × 3.1 × 1.4 | " |
| 238d | 453 | | 2 × 1.8 × 0.9 | " |
| 238e | 49 | | 2.4 × 2.2 × 1 | " |
| 239 | 59 | IM 70172 | 20.9 × 14.6 × 4.4 | " |
| 240 | 73 | IM 70287 | 10.2 × 11.1 × 4.2 | " |
| 241 | 74 | | 10.2 × 12.2 × 5.4 | " |
| 242 | 28 | | 11.6 × 12.5 × 3.8 | " |
| 243 | 44 | | 13.5 × 10.2 × 4.1 | " |
| 244 | 11 | | 8.6 × 10.6 × 2.9 | " |
| 245 | 278 | IM 70173 | 19 × 13.7 × 4.2 | " |
| 246 | 250 | | 7.9 × 7.5 × 4.1 | " |
| 247 | 114 | IM 70174 | 20 × 24.5 × 6.7 | " |
| 248 | 73 | | 15.8 × 16.1 × 4.2 | " |
| 249 | 64 | | 7.3 × 6.4 × 1.9 | " |
| 250 | 298 | IM 70175 | 18.3 × 13.4 × 5 | " |
| 251 | 20 | IM 70288 | 8.7 × 9.7 × 4 | " |
| 252 | 389 | IM 70176 | 13.7 × 13.2 × 4.4 | " |
| 253 | 14 | IM 70177 | 8.4 × 16.7 × 4.2 | " |
| 254 | 13 | IM 70178 | 16.9 × 10.7 × 4.5 | Room 31, cut in Level I, smashed together with AbS-T 233 and AbS-T 302 |
| 255 | 79 | | 9.4 × 7.5 × 4.4 | Room 31, cut in Level I |
| 256a | 280 | IM 70179 | 6.3 × 7.6 × 2.3 | " |
| 256b | 279 | IM 70179 | 3.1 × 4.5 × 1.8 | " |
| 257 | 281 | IM 70289 | 6.6 × 5.2 × 2.3 | " |
| 258 | 124 | IM 70180 | 15.8 × 17.8 × 7.5 | " |
| 259 ¹² | | | 16.6 × 10 × 3.8 | " |
| 260a | 122 | IM 70290 | 16.9 × 19 × 6.8 | " |
| 260b | 147 | IM 70290 | 3.2 × 2.9 × 0.6 | " |
| 260c ¹³ | | IM 70290 | 3.4 × 1.1 × 2.1 | " |
| 260d | 144 | IM 70290 | 2.7 × 2.4 × 1 | " |
| 261 | 7 | | 5.1 × 6.5 × 3.3 | " |
| 262 | 332 | | 5.8 × 3.8 × 1.6 | " |

11. Not measured.

12. Unpublished. Fragment with badly flaked and worm-damaged surface. It is perhaps an UD.GAL.NUN text.

13. Unpublished. Worthless fragment.

INDEX OF FIELD NUMBERS

| FIELD NUMBER | PUBLICATION NUMBER | MUSEUM NUMBER | DIMENSIONS | FINDSPOT |
|--------------------------------|--------------------|---------------|-------------------|---|
| AbS-T 263 | 322 | IM 70181 | 9.6 × 8.1 × 3.5 | Room 31, cut in Level I |
| 264 | 168 | | 9.2 × 16.1 × 4.9 | " |
| 265 | 136 | | 14.4 × 16.9 × 5.3 | " |
| 266 | 115 | IM 70308 | 23.6 × 17 × 8 | " |
| 267 | 123 | IM 70305 | 14.3 × 17 × 5.7 | " |
| 268 | 118 | IM 70291 | 9.8 × 12.7 × 4.1 | " |
| 269 _a | 162 | IM 70183 | 14.2 × 23.2 × 5.1 | " |
| 269 _b | 261 | IM 70183 | 1.7 × 1.8 × 0.8 | " |
| 270 | 131 | IM 70184 | 12.5 × 24 × 5.5 | " |
| 271 | 167 | IM 70292 | 10 × 14.2 × 5 | " |
| 272 | 133 | IM 70185 | 14.8 × 16.6 × 4.6 | " |
| 273 | 115 | IM 70186 | 21.4 × 18 × 5.4 | " |
| 274 | 113 | IM 70187 | 16 × 18.7 × 5.4 | " |
| 275 | 129 | IM 70307 | 15.3 × 24.5 × 6.6 | " |
| 276 | 121 | | 12.9 × 16.4 × 3.6 | " |
| 277 | 164 | | 8 × 9.4 × 1.4 | " |
| 278 _a ¹⁴ | 211 | | 8.6 × 8.3 × 1.9 | " |
| 278 _b ¹⁴ | 200 | | | " |
| 279 | 283 | IM 70188 | 13.6 × 21 × 6 | " |
| 280 | 329 | IM 70189 | 13.6 × 13.4 × 5.3 | " |
| 281 _a | 282 | IM 70190 | 15.8 × 18.3 × 9.6 | " |
| 281 _b ¹⁵ | | | 1 × 5.3 × 2.5 | " |
| 282 | 117 | IM 70191 | 17.4 × 14.1 × 3.7 | " |
| 283 | 253 | IM 70192 | 8.2 × 9.2 × 3.3 | " |
| 284 | 307 | IM 70193 | 7.3 × 6.7 × 1.5 | " |
| 285 | 204 | | 10.8 × 6.3 × 3.2 | " |
| 286 | 25 | | 7.6 × 11.3 × 3 | " |
| 287 | 166 | | 4.2 × 5 × 1.6 | " |
| 288 | 203 | | 11.5 × 14 × 2 | " |
| 289 | 221 | | 5.6 × 6.9 × 1.5 | " |
| 290 | 175 | IM 70301 | 5 × 8.6 × 1.6 | " |
| 291 _a | 178 | IM 70302 | 5.7 × 8.4 × 1.9 | " |
| 291 _b | 186 | IM 70302 | 2.6 × 2.8 × 1.2 | " |
| 291 _c | 179 | IM 70302 | 1.9 × 2.4 × 1 | " |
| 292 | 254 | IM 70303 | 16.8 × 17.8 × 3.8 | " |
| 293 | 283 | | 10 × 14.1 × 3.5 | " |
| 294 | 21 | | 11.6 × 12.2 × 3.6 | " |
| 295 | 257 | IM 70194 | 8.2 × 5 × 2.7 | " |
| 296 | 151 | IM 70304 | 27.5 × 22.7 × 5.7 | " |
| 297 | 165 | | 5.3 × 6.9 × 1.3 | " |
| 298 | 119 | | 13.5 × 14.2 × 4.1 | " |
| 299 ¹⁶ | | | 6.4 × 4.8 × 1.9 | " |
| 300 | 222 | | 6.2 × 4.5 × 1.6 | " |
| 301 | 41 | | 8.3 × 10 × 4.5 | " |
| 302 | 308 | IM 70295 | 13 × 12.5 × 5.4 | Room 31, cut in Level I, smashed together with AbS-T 233 and AbS-T 254. |
| 303 | 24 | | 6 × 5.9 × 2.8 | Room 31, cut in Level I |
| 304 | 137 | IM 70296 | 16 × 9.5 × 4.1 | " |
| 305 | 323 | | 12.1 × 7.4 × 3 | " |
| 306 | 342 | IM 70297 | 10.8 × 8.6 × 3.8 | " |
| 307 | 174 | IM 70294 | 9 × 5.2 × 1.3 | " |
| 308 | 287 | IM 70203 | 10.4 × 12.4 × 5.8 | " |

14. Dimensions given here are of AbS-T 278_a and *b* together, which had been joined erroneously.

15. Unpublished. Worthless fragment.

16. Crumpled exercise tablet; see Fig. 25.

INDEX OF FIELD NUMBERS

| FIELD NUMBER | PUBLICATION NUMBER | MUSEUM NUMBER | DIMENSIONS | FINDSPOT |
|--------------------|--------------------|---------------|-------------------|---|
| AbS-T 309 | 146 | | 5.4 × 6.8 × 1.7 | Room 31, cut in Level I |
| 310 | 43 | IM 70196 | 10.5 × 17.1 × 4 | " |
| 311 | 39 | IM 70298 | 16.7 × 19.7 × 4 | " |
| 312 | 42 | IM 70299 | 17.5 × 11.2 × 5 | " |
| 313 | 205 | | 11.2 × 10.5 × 4.4 | " |
| 314 | 252 | | 9.8 × 7.9 × 4.4 | " |
| 315 | 81 | | 7.2 × 7.2 × 1.7 | " |
| 316 | 78 | | 5.6 × 4.6 × 0.9 | " |
| 317a | 98 | | 3.5 × 5 × 1.4 | " |
| 317b | 485 | | 5.4 × 1.8 × 2.5 | " |
| 317c | 432 | | 5 × 4 × 1.3 | " |
| 317d | 435 | | 4.5 × 2.3 × 1.4 | " |
| 317e | 251 | | 2 × 4.5 × 1.3 | " |
| 317f | 433 | | 3.2 × 3 × 0.9 | " |
| 317g | 434 | | 2.5 × 2 × 1.2 | " |
| 317h | 72 | | 2.8 × 3.2 × 2 | " |
| 317i ¹⁷ | | | 1.2 × 2.5 × 1.4 | " |
| 317j ¹⁷ | | | 1.9 × 1.5 × 1 | " |
| 318 ¹⁸ | 264 | | | " |
| 319a | 66 | | 4.9 × 4.4 × 1.3 | " |
| 319b | 70 | | 5.1 × 5.7 × 1.8 | " |
| 320a | 335 | | 5.5 × 7.3 × 1.8 | " |
| 320b | 428 | | 1 × 4.2 × 2.7 | " |
| 321 | 177 | | 10.6 × 8.6 × 2 | " |
| 322 | 272 | | 4 × 3.1 × 1.4 | " |
| 323 | 218 | | 6.6 × 6.5 × 2.8 | Room 31, cut in Level I, with AbS-T 322 |
| 324 | 134 | IM 70197 | 6.4 × 8.4 × 2 | Room 31, cut in Level I |
| 325 | 176 | | 4.5 × 2.9 × 1.5 | " |
| 326 | 438 | | 4.5 × 4.9 × 2.1 | " |
| 327 | 336 | | 4.6 × 4 × 2 | " |
| 328 | 440 | | 3.4 × 1.2 × 2.6 | " |
| 329 | 302 | | 16.9 × 10.2 × 5 | Room 21, cut in Level I, just inside door |
| 330 | 9 | | 4.8 × 8.7 × 2.5 | Room 31, cut in Level I |
| 331 | 1 | | 8.2 × 6.1 × 2.1 | " |
| 332 | 459 | | 4.2 × 5.3 × 2.2 | " |
| 333 | 248 | | 21.1 × 11.2 × 5.2 | " |
| 334 | 260 | | 3.2 × 3.1 × 1 | " |
| 335 | 439 | | 3.9 × 4.5 × 3 | " |
| 336a | 77 | | 3.6 × 4.2 × 1.8 | " |
| 336b | 68 | | 1.7 × 2.7 × 1 | " |
| 337 | 334 | | 3.4 × 4.3 × 1.7 | " |
| 338 | 126 | | 6.1 × 4.8 × 1.4 | " |
| 339a | 135 | | 6.3 × 3.6 × 1.2 | " |
| 339b | 170 | | 2.3 × 3.3 × 1 | " |
| 340 | 171 | | 3.4 × 5 × 1.2 | " |
| 341 | 75 | | 7.9 × 6 × 1.6 | " |
| 342 | 30 | | 6.1 × 6.8 × 3 | " |
| 343 | 33 | IM 70198 | 24 × 28.5 × 5.4 | " |
| 344 | 128 | IM 70199 | 30.3 × 22.9 × 7.2 | " |
| 345 | 514 | | 4.4 × 3.4 × 1.2 | " |
| 346 | 341 | | 5.2 × 5 × 1.4 | " |
| 347 | 311 | | 3.8 × 3.8 × 1.1 | " |
| 348 | 173 | | 5.3 × 6.1 × 1.5 | Room 31, cut in Level I, adhering reverse to reverse to AbS-T 288 |

17. Unpublished. Worthless fragment.

18. Not measured.

INDEX OF FIELD NUMBERS

107

| FIELD NUMBER | PUBLICATION NUMBER | MUSEUM NUMBER | DIMENSIONS | FINDSPOT |
|-------------------|--------------------|---------------|-------------------|---|
| AbS-T 349 | 201 | | 9 × 5.2 × 1.3 | Room 31, cut in Level I |
| 350 | 223 | | 4.5 × 4.5 × 1.6 | " |
| 351a | 301 | | 3.5 × 5.6 × 2.1 | " |
| 351b | 436 | | 4.7 × 1.8 × 2.2 | " |
| 352 | 305 | | 5.8 × 4.5 × 1.1 | Room 31, cut in Level I, on surface of AbS-T 312 |
| 353 | 219 | | 5.8 × 4.5 × 1.4 | Room 31, cut in Level I, in dirt around AbS-T 207 |
| 354a | 288 | IM 70200 | 3.4 × 11.3 × 3.9 | " |
| 354b | 289 | IM 70200 | 4 × 4.2 × 0.9 | " |
| 354c | 290 | IM 70200 | 4.2 × 3 × 1.5 | " |
| 354d | 291 | IM 70200 | 3.5 × 3.9 × 1.3 | " |
| 354e | 289 | IM 70200 | 3.5 × 2.3 × 1.1 | " |
| 354f | 293 | IM 70200 | 4.3 × 2.7 × 1.5 | " |
| 354g | 292 | IM 70200 | 2.3 × 2.8 × 1.1 | " |
| 355 | 388 | IM 70306 | 17.4 × 19.7 × 6 | Room 31, cut in Level I |
| 356 | 437 | | 3.8 × 3.9 × 1.6 | " |
| 357 | 172 | | 3 × 6 × 3.5 | " |
| 358 | 163 | IM 70300 | 23 × 25 × 5.5 | " |
| 359 | 328 | IM 70201 | 21.8 × 23.2 × 4.4 | " |
| 360 | 154 | | 7.7 × 6.2 × 2.9 | Room 31, Level I fill |
| 361 | 271 | | 7.6 × 6.5 × 1.6 | " |
| 362 | 99 | | 3.1 × 6.1 × 1.7 | Room 31, cut in Level I |
| 363 | 142 | IM 70202 | 22.4 × 32.8 × 7.3 | " |
| 364 | 220 | | 9 × 7.4 × 4.4 | " |
| 365 | 299 | | 9.6 × 5.2 × 0.9 | " |
| 366 | 415 | | 4.1 × 4.8 × 2.3 | " |
| 367 | 416 | | 3.4 × 2.1 × 1.4 | " |
| 368 ¹⁹ | | | 5.2 × 6.8 × 1.5 | " |
| 369 | 38 | | 3.9 × 3.3 × 1.7 | " |
| 370 | 339 | | 4.2 × 2.6 × 2.2 | " |
| 371 | 269 | | 4.2 × 4.4 × 1 | " |
| 372a | 46 | | 3.5 × 6.4 × 1 | " |
| 372b | 417 | | 3.3 × 3.3 × 1.1 | " |
| 373 | 300 | | 4 × 3.5 × 1.2 | " |
| 374 | 418 | | 2 × 1.8 × 0.9 | " |
| 375 | 58 | | 2.2 × 2.9 × 1.2 | " |
| 376a | 303 | | 5.3 × 6.5 × 3.6 | " |
| 376b | 158 | | 1.7 × 4.2 × 2.8 | " |
| 377a | 306 | | 2 × 9.5 × 2.8 | " |
| 377b | 304 | | 2.7 × 3.5 × 0.8 | " |
| 378 | 169 | | 2.4 × 9.5 × 4.5 | " |
| 379 | 138 | | 6.1 × 4.6 × 1.4 | " |
| 380a | 132 | IM 70205 | 21 × 22.8 × 5.2 | " |
| 380b | 209 | IM 70205 | 3.4 × 4.3 × 2.7 | " |
| 380c | 208 | IM 70205 | 4 × 4 × 1.8 | " |
| 380d | 217 | IM 70205 | 1.3 × 3.5 × 0.8 | " |
| 381 ²⁰ | | | 6.8 × 10.5 × 4.1 | " |
| 382 | 419 | | 6.2 × 7.3 × 3.9 | " |
| 383 | 421 | | 6 × 9 × 4 | " |
| 384a | 39 | | 3.8 × 2.5 × 1.1 | " |
| 384b | 39 | | 4.4 × 2.1 × 1 | " |

19. Reverse of tablet with a design; see Fig. 27.

20. Fragment with upper edge preserved. The tablet has been smashed in such a way that part of it (or part of a

different tablet) is at a lower level. The most legible lines are [m]es an túm and [x ba]lag in column ii and a-a (or za-za)-ba₄ in column iii.

INDEX OF FIELD NUMBERS

| FIELD NUMBER | PUBLICATION NUMBER | MUSEUM NUMBER | DIMENSIONS | FINDSPOT |
|------------------|--------------------|---------------|-------------------|---|
| AbS-T 385 | 270 | | 2.9 × 2.8 × 1.1 | Room 31, cut in Level I |
| 386 | 465 | | 2.8 × 4.5 × 1.8 | " |
| 387 _a | 420 | | 3.9 × 2 × 2.1 | " |
| 387 _b | 295 | | 1.9 × 2.5 × 2.2 | " |
| 387 _c | 422 | | 4.7 × 4.3 × 1.5 | " |
| 387 _d | 423 | | 3.3 × 2.5 × 1.5 | " |
| 387 _e | 296 | | 2.3 × 3.3 × 1.5 | " |
| 387 _f | 40 | | 2.1 × 2 × 0.8 | " |
| 388 _a | 424 | | 3.6 × 3 × 1.3 | " |
| 388 _b | 425 | | 2 × 3.5 × 1.2 | " |
| 389 _a | 338 | | 3.8 × 3.8 × 1.2 | " |
| 389 _b | 71 | | 2.5 × 3 × 2.5 | " |
| 389 _c | 140 | | 3.2 × 3.5 × 1.5 | " |
| 389 _d | 139 | | 3.6 × 2.3 × 2.6 | " |
| 389 _e | 399 | | 2.5 × 3.2 × 1.1 | " |
| 389 _f | 398 | | 3.2 × 1.3 × 2 | " |
| 389 _g | 230 | | 4.2 × 1.6 × 3.6 | " |
| 389 _h | 403 | | 3.4 × 1.9 × 1.9 | " |
| 389 _i | 402 | | 1 × 3.1 × 1.1 | " |
| 389 _j | 401 | | 1.7 × 2.6 × 1.7 | " |
| 389 _k | 404 | | 2.7 × 3.4 × 1.3 | " |
| 389 _l | 405 | | 3 × 2.4 × 1.2 | " |
| 389 _m | 407 | | 2.4 × 3.1 × 1.3 | " |
| 389 _n | 454 | | 2.2 × 2.1 × 1.2 | " |
| 390 _a | 333 | | 2.4 × 2.8 × 1.3 | " |
| 390 _b | 284 | | 3.3 × 2 × 1.4 | " |
| 390 _c | 406 | | 2.3 × 2.1 × 1.1 | " |
| 391 | 350 | | 13 × 10 × 3.5 | " |
| 392 _a | 26 | | 3.8 × 2.1 × 1.6 | " |
| 392 _b | 410 | | 4.9 × 1.1 × 3.4 | " |
| 392 _c | 315 | | 4 × 5.5 × 2.3 | " |
| 392 _d | 1 | | 2.7 × 5.1 × 2.6 | " |
| 392 _e | 286 | | 2.5 × 6.4 × 3.6 | " |
| 392 _f | 1 | | 2.8 × 2.2 × 0.9 | " |
| 392 _g | 285 | | 2.8 × 2.7 × 1.2 | " |
| 392 _h | 214 | | 2.9 × 4.1 × 1.3 | " |
| 392 _i | 409 | | 3 × 2.9 × 1 | " |
| 392 _j | 231 | | 2.4 × 3.1 × 1 | " |
| 392 _k | 408 | | 1.9 × 2.7 × 0.7 | " |
| 392 _l | 411 | | 3.6 × 2.6 × 1.2 | " |
| 392 _m | 233 | | 3.7 × 2 × 2.6 | " |
| 392 _n | 412 | | 1.2 × 2.9 × 0.7 | " |
| 392 _o | 17 | | 1.4 × 4 × 1.7 | " |
| 392 _p | 232 | | 4.8 × 3 × 1.3 | " |
| 392 _q | 22 | | 2.6 × 2.8 × 1 | " |
| 392 _r | 27 | | 2.2 × 3.3 × 1.1 | " |
| 392 _s | 206 | | 3.8 × 2.8 × 1 | " |
| 392 _t | 187 | | 3.2 × 3.9 × 1.1 | " |
| 392 _u | 457 | | 2.4 × 3.9 × 1 | " |
| 393 | 256 | IM 70204 | 19.8 × 19.8 × 4.3 | Room 31, cut in Level I, reverse adhering to obverse of AbS-T 228 |
| 394 | 472 | | 7.4 × 10.4 × 3.2 | Room 31, cut in Level I |
| 395 | 476 | | 7.1 × 1.9 × 3.3 | " |
| 396 | 481 | | 8.1 × 7.9 × 2 | " |
| 397 | 317 | | 8.6 × 1.6 × 3 | " |

INDEX OF FIELD NUMBERS

109





















| FIELD NUMBER | PUBLICATION NUMBER | MUSEUM NUMBER | DIMENSIONS | FINDSPOT |
|-----------------|-----------------------|------------------|------------------|--|
| AbS-T 398 | 130 | | 9.7 × 12 × 4.6 | Room 31, cut in Level I |
| 399 | 479 | | 14.2 × 13 × 3.7 | ” |
| 400 | 488 | | 15.7 × 13 × 1.5 | ” |
| 401 | 141 | | 10 × 5.9 × 3.1 | ” |
| 402 | 153 | | 10.5 × 8.5 × 3.6 | ” |
| 403a | 12 | | 3 × 4.2 × 1.2 | ” |
| 403b | 294 | | 2.2 × 3.3 × 3.4 | ” |
| 403c | 413 | | 2.2 × 3.5 × 2.5 | ” |
| 403d | 452 | | 2.1 × 3 × 1.3 | ” |
| 403e | 150 | | 3 × 2.7 × 2.1 | ” |
| 403f | 451 | | 2 × 2.6 × 1 | ” |
| 403g | 450 | | 2.8 × 1.4 × 1.1 | ” |
| 404 | 149 | | 5.6 × 3.8 × 4 | ” |
| 405 | 148 | | 2.5 × 5.1 × 1.5 | Room 31, Level IB fill, middle of room |
| 406 | 414 | | 5.3 × 1.8 × 2.8 | Room 31, cut in Level I |
| 407a | 234 | | 2.7 × 3.2 × 1.8 | ” |
| 407b | 249 | | 4 × 3.6 × 1.2 | ” |
| 408 | 484 | | 2.8 × 5.4 × 1.8 | ” |
| 409a | 456 | | 2.9 × 2.5 × 1.1 | ” |
| 409b | 312 | | 2.7 × 3.8 × 1.1 | ” |
| 410a | 155 | | 4.4 × 3 × 1.6 | ” |
| 410b | 156 | | 3.4 × 2.2 × 0.8 | ” |
| 411 | 482 | | 3.3 × 4.7 × 2.5 | ” |
| 412 | 226 | | 1.9 × 3.2 × 1 | ” |
| 413 | 237 | | 7.2 × 3.8 × 1.4 | ” |

LIST OF SIGNS AND TERMS DISCUSSED

This index includes some items from the transliterations of Early Dynastic lists of occupations in *MSL XII*, where the assumed reading was given (with the standard reading or LAK number in parentheses), which were not commented upon there.

- a-zu_x(AZU), *RA LX* 176, n. 4
 AN.MUŠ.ĤA.DIN.IR.BALAG (irĥan), *JCS XX* 80, n. 54; p. 55 above
 AŠ (= bar), *JCS XX* 83
 abzu, *Bi.Or. XXVI* 207, n. 7
 *ANŠE in *ANŠE.BAR.AN, p. 96 above
 aš_x(ŠAR × DIŠ), *JCS XXIV* 1–2
 bād, p. 56 above
 baĥar (LAK 742), *Bi.Or. XXVI* 209
 bar (written AŠ), *JCS XX* 83
 dagal, p. 56 above
 DI (as variant of LAK 171), p. 32 above
 dūr, *JCS XX* 77, n. 37
 EZEN × AN, p. 56 above
 gala (written UŠ.DŪR), *JCS XX* 78, n. 37
 GAM + GAM, *Orientalia* n.s. XXXVI 65, n. 4
 gaz (KUM), *MSL XII* 12, l. 153
 ġĪR, pp. 69–70 above
 ġĪR-gunū, pp. 69–70 above
 giri (new sign), *ZA LXI* 206
 GIŠ × TAG₄, *MSL XII* 20, l. 105
 ĤŪB (as variant of TUK), *MSL XII* 20, note to l. 67
 IM (šeg_x?), p. 54 above
 irĥan, p. 55 above
 kam (ŠAR × DIŠ), p. 88 above
 kisig_x, see ġĪR-gunū
 kišib, *JCS XX* 87, n. 107
 ku, *JCS XX* 77, n. 37
 ◀◊ LAK 23, *JCS XXIV* 2
 ◀◊ LAK 24, *JCS XXIV* 2
 ◀◊ LAK 26 (kun), *JCS XX* 84, n. 78

LIST OF SIGNS AND TERMS DISCUSSED









-  LAK 31, p. 53 above
 LAK 32, p. 53 above
 LAK 117, *RA* LX 6
 LAK 171,¹ p. 32 above
 LAK 249 (alim), *ZA* LXI 205
 LAK 250 (lulim), *ZA* LXI 205 and p. 32, n. 23 above
 LAK 263 (šeg₉), *ZA* LXI 205
 LAK 264 (dàra), *ZA* LXI 205
 LAK 363, *JCS* XX 2
 LAK 382, p. 78 above
 LAK 387,² p. 77 above
 LAK 489, *MSL* XII 11–12, note to l. 1 and p. 56 above
 LAK 492,¹ *JCS* XX 87, n. 103
 LAK 611, p. 56 above
 LAK 613, p. 56 above
 LAK 617, p. 56 above
 LAK 647, p. 35, n. 36 above
 LAK 668, *MSL* XII 12, note to l. 6
 LAK 672,¹ *JCS* XX 84, n. 78 and p. 62 above
 LAK 797, *RA* LX 175
 LAK 798, *RA* LX 175
 LIL_x (KID), see ⁴Nin-KID
 munsub, see LAK 672
 MÜŠ-gunú, p. 78 above
 na₅, *ZA* LXI 195
 nám (*TÚG), *JCS* XX 81, n. 59
⁴Nám-nun, *JCS* XX 81, n. 59; *ZA* LXI 204
 nin, *Bi.Or.* XXVI 207, n. 1
⁴Nin-girim_x(A. ḪA. MUŠ.DU, etc.), *JCS* XX 80, n. 55
⁴Nin-KID,³ *JCS* XX 84, n. 85

1. The sign form is given as attested in Abū Šalābīkh tablets.

2. Errors in *LAK* in the form of this sign as attested in Fara texts have been corrected in this drawing.

3. Since first discussing the problem of the writing of

Ninlil's name with the sign KID, I have noted evidence that in spite of the graphic distinction between LIL and KID, in this instance KID is to be read lil_x. In an Ur III offering list from Nippur (6 NT 742, line 3) occurs a line udu ⁴Nin-KID-lá "a sheep for Ninlil."

- rib, *ZA* LXI 205
 SAG × TAB, *MSL* XII 20, note to l. 67
 SANGA (“scribe”), *Orientalia* n.s. XXXVI 59, n. 1
 SUD (= sù), *Orientalia* n.s. XXXVI 63, n. 2; p. 71 above
 *ŠE + NÁM, *MSL* XII 12, note to l. 9
 šeg_x (IM), p. 54 above
 šeš₄, *MSL* XII 12, note to l. 6
 ši (= šè), *JCS* XX 81, n. 59
 šibir, *ZA* LXI 206
 TAG (tibir), *ZA* LXI 206
 tibira (DUB + NAGAR), *Bi.Or.* XXVI 209
 rúG, *JCS* XX 81, n. 59; see also nám
^drúG-nun, see ^dNám-nun
 tukul, *RA* LX 10
 ù, p. 91 above
 ul₄, see GÍR-gunú
 UD + NUN, *JCS* XX 83, n. 75
 umun₂ (LAK 155), *MSL* XII 12, note to l. 29
 zíz, *JCS* XX 87, n. 102
 zu_x(AZU), *RA* LX 176, n. 4
-  *MSL* XII 20, note to l. 67
-  p. 71 above
-  p. 77 above, note to l. 123
-  *MSL* XII 12, note to l. 9
-  p. 54 above
-  (giri), *ZA* LXI 206
-  pp. 70–71 above
-  *Orientalia* n.s. XXXVI 63, n. 5
-  p. 55 above

PLATES

INTRODUCTION TO THE CUNEIFORM COPIES

The conventions employed in the copies are mostly standard among Assyriologists. To avoid possible misunderstanding, I make them explicit here. Preserved edges of tablets are indicated by a heavy solid line. A heavy dotted line indicates location of the edge of the tablet, even though it is not preserved at the particular point indicated (this is particularly the case where the edge is preserved on an uninscribed portion of the tablet which I have not reproduced; in other instances, the location of the edge can be known exactly from the thickness and curvature of the tablet and column width). A thinner solid line indicates the limits of preserved surface of tablets; it is also used between fragments rejoined after cataloguing. A very thin line is used to indicate the major cracks in a tablet. In many instances these cracks are quite wide on the original tablets, and particularly in severely damaged areas it has often been difficult to determine precisely how the join should be. In cases where I have some doubt about the correctness of my solution, mention has been made in the Catalogue of Published Texts. A thin line also surrounds areas (left blank in the copy) where a piece of the surface layer of the tablet is broken out (and which may consequently be published as a fragment in this volume). Hatching indicates damaged surface. No distinction has been made between broken surface, areas damaged by worms, animals, or roots, and areas near the edges of tablets which are obliterated by smoothing. Erasures are indicated by a fine dotted line surrounding the erased sign. *Sic* has been used sparingly. It indicates in general an anomalous or erroneous sign. For example, it may indicate that a scribe has omitted an essential wedge or has given a sign an unusual feature (such as particular wedges going in the "wrong" direction). Use of *sic* has not been applied consistently throughout and in general not to poorly written exercise tablets at all.

Column numbers are indicated in the copies for texts having more than five columns. Unless there is specific evidence to the contrary, I have arbitrarily assumed that the sequence of columns on the reverse of tablets is right to left. Obverse and reverse are indicated in the plates only when both are preserved and inscribed. Since the lines can usually be counted without difficulty, I assume that designating column numbers in the copies will meet normal scholarly needs. The copies have been reproduced at the same size as the originals.

Line numbers given in the plates correspond to line numbers in the text editions in this volume.

The width of the line indicating case and column dividers does not necessarily reflect the depth or width of these on the tablet. In many instances, the vertical line on the right side of the cases is drawn through parts of signs. Final wedges of signs may thus be obliterated, particularly in signs ending in a vertical wedge. I have drawn them only when I could see some trace remaining.

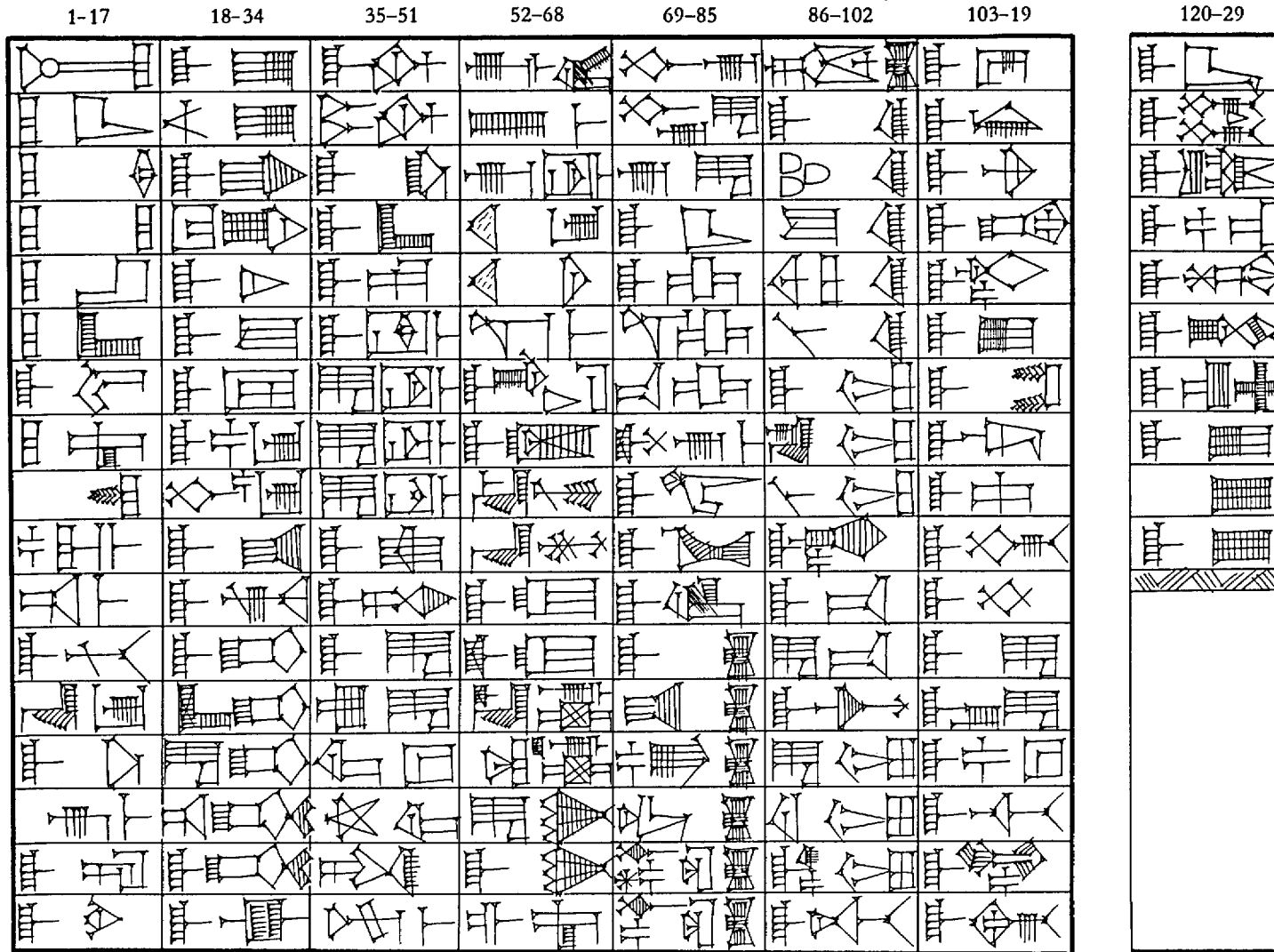

VARIANTS



II. 31-33 (Source A)



II. 84-85 (Source A)



I. 86 (Source B)

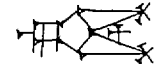

I. 106 (Source G)

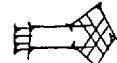

I. 107 (Source G)

No. 1

PLATE 2

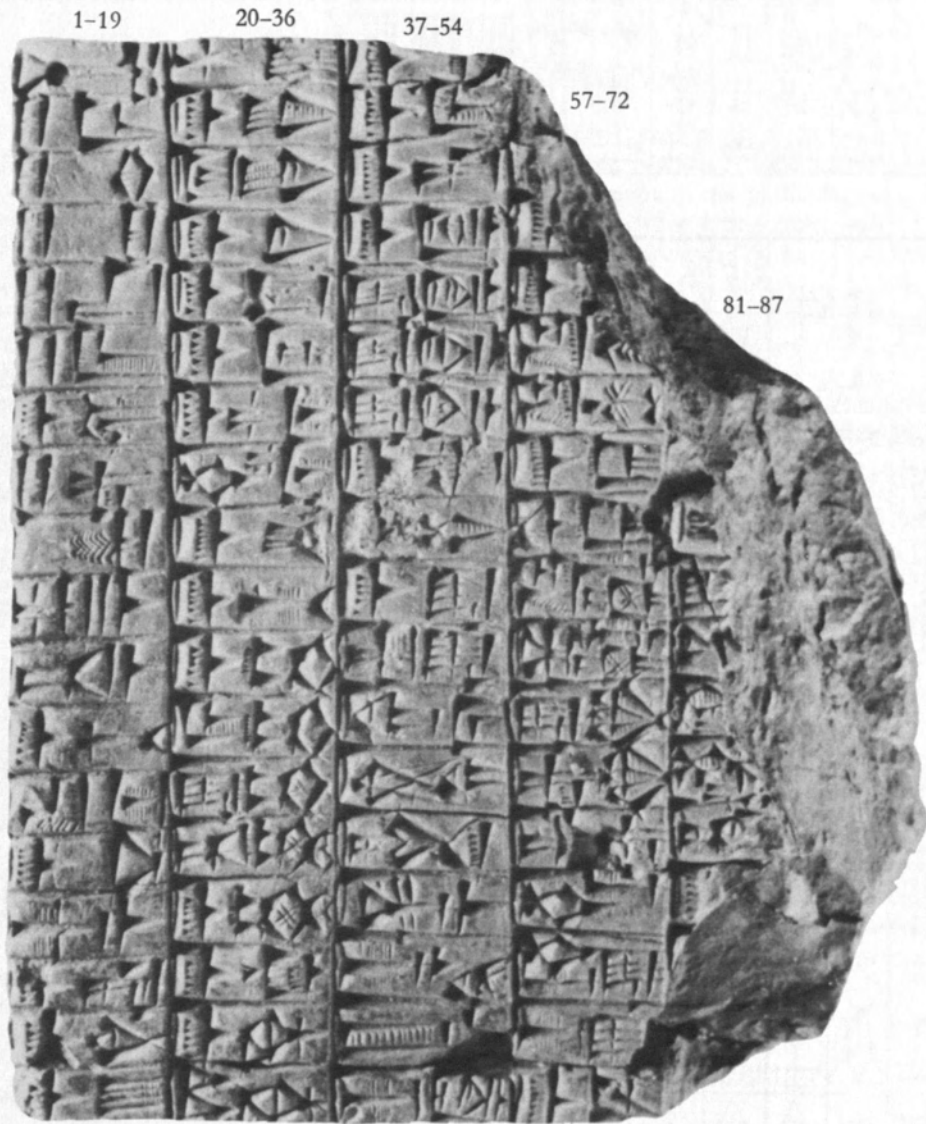

Obverse
No. 2



No. 3

PLATE 4

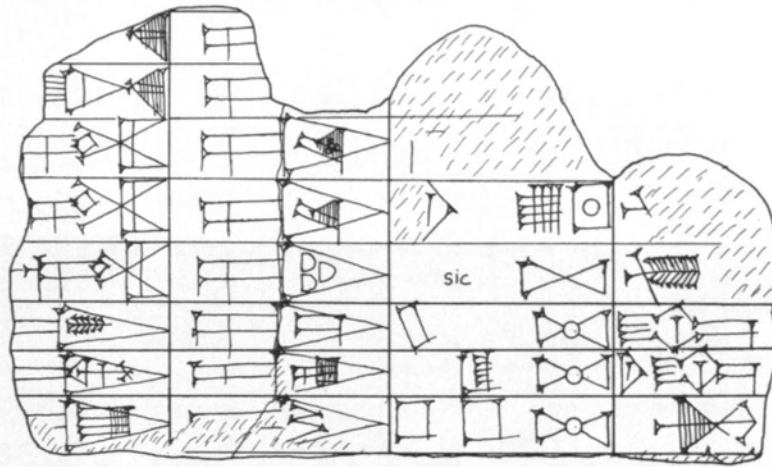

No. 4

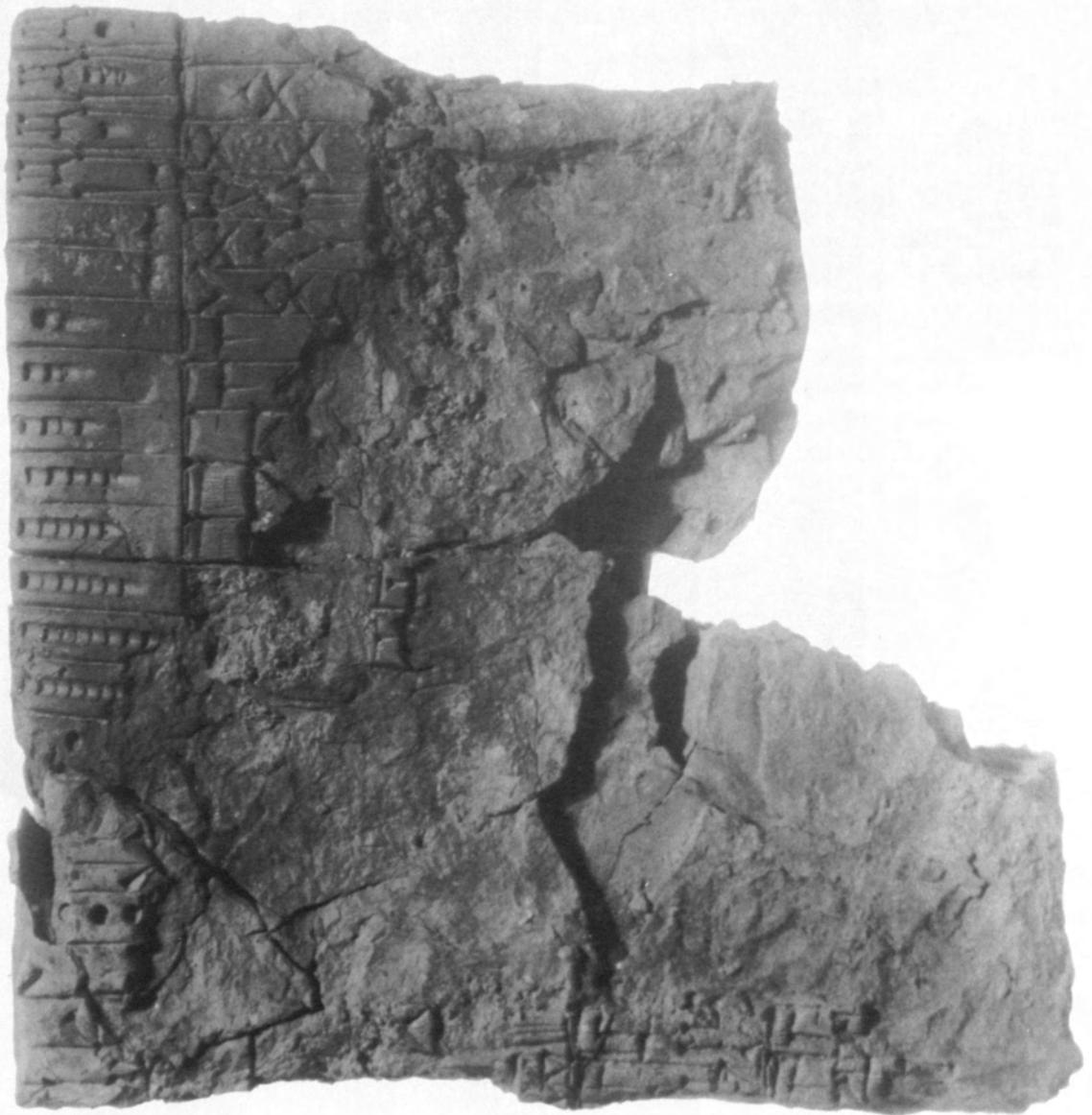

No. 5

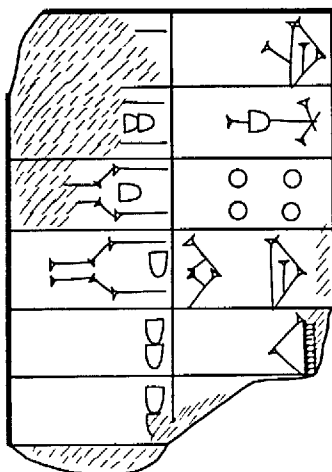

No. 6

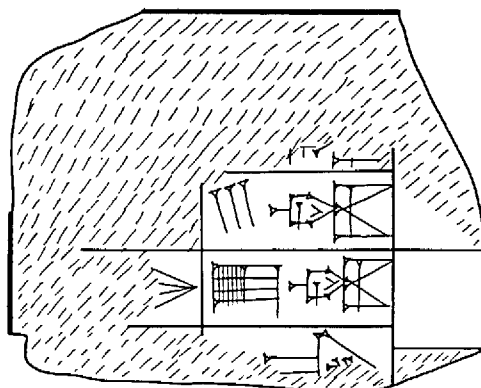

No. 7

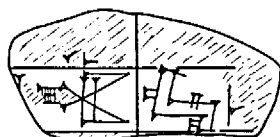

No. 8

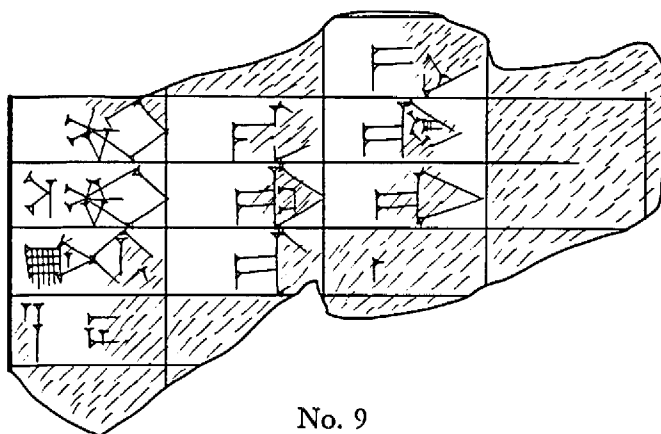

No. 9

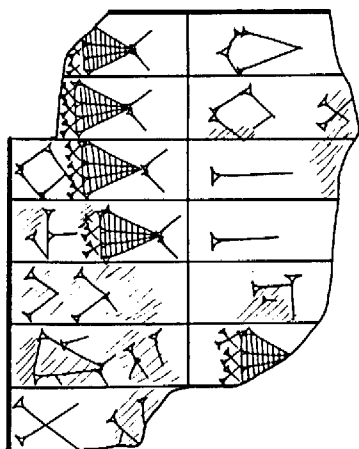

No. 10

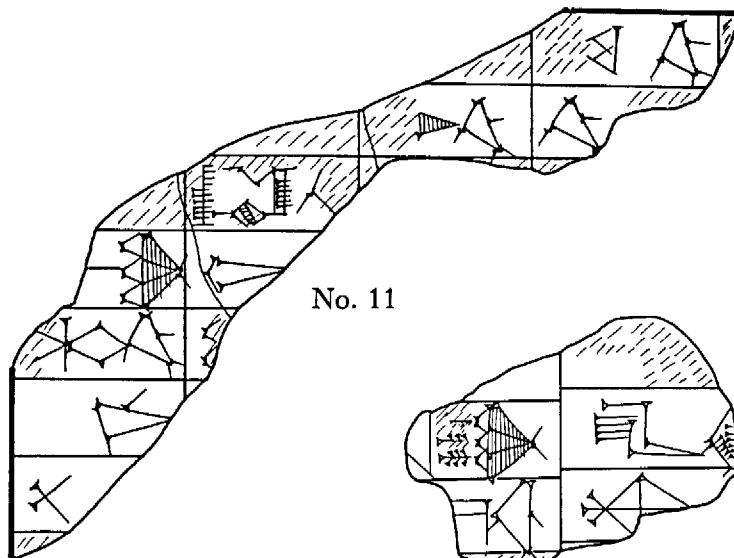

No. 11

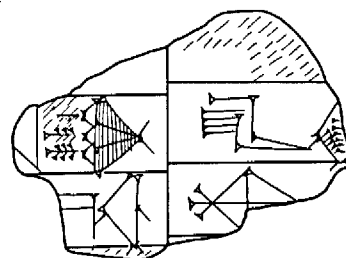

No. 12

PLATE 6

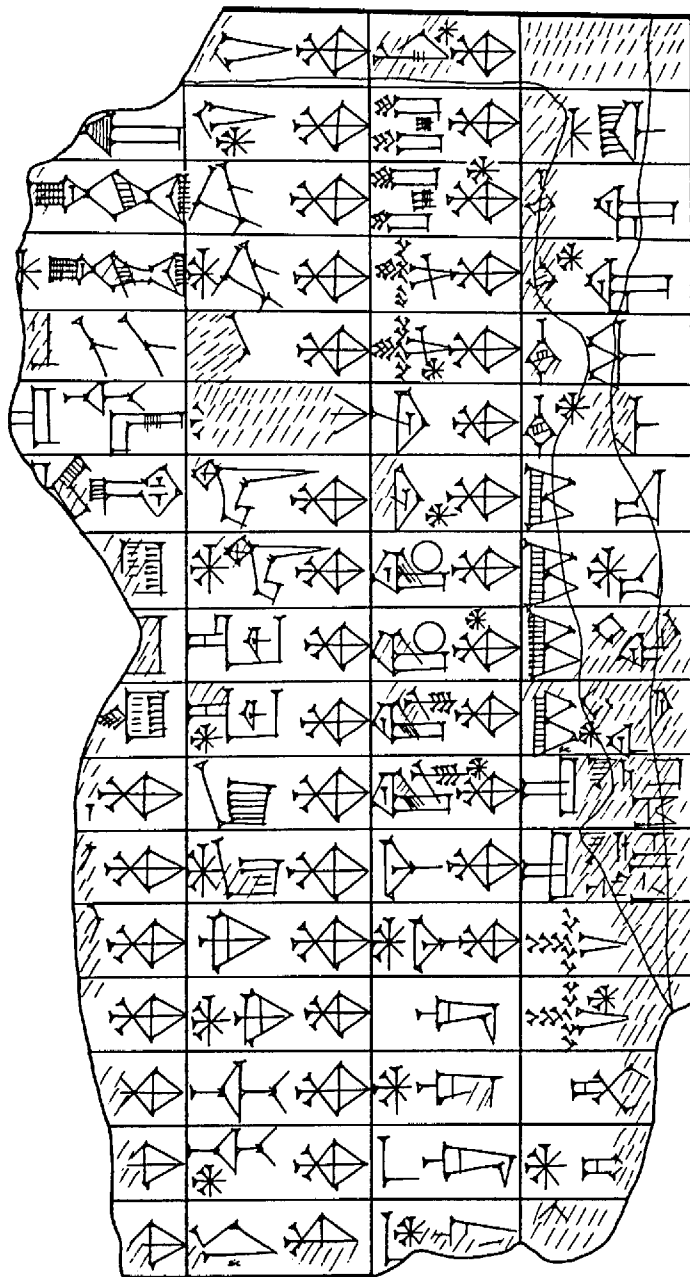

Obverse
No. 13

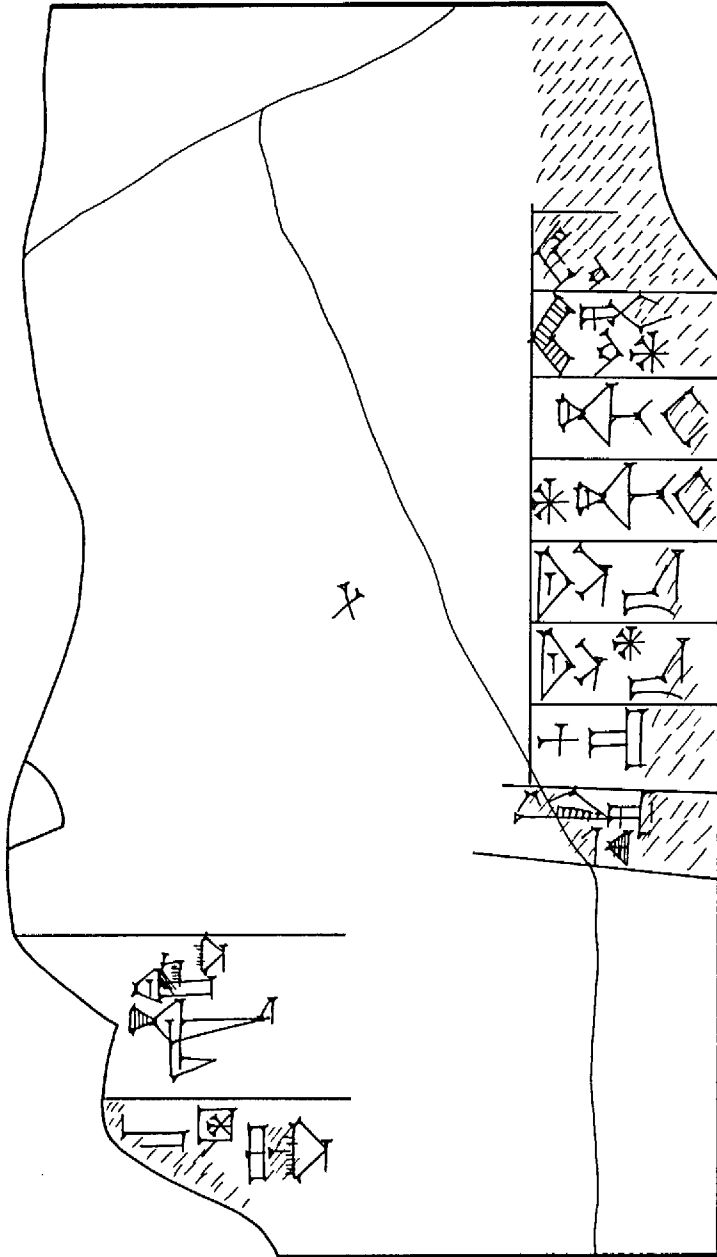

Reverse
No. 13

PLATE 8

i ii iii iv v vi vii viii



Obverse
No. 14

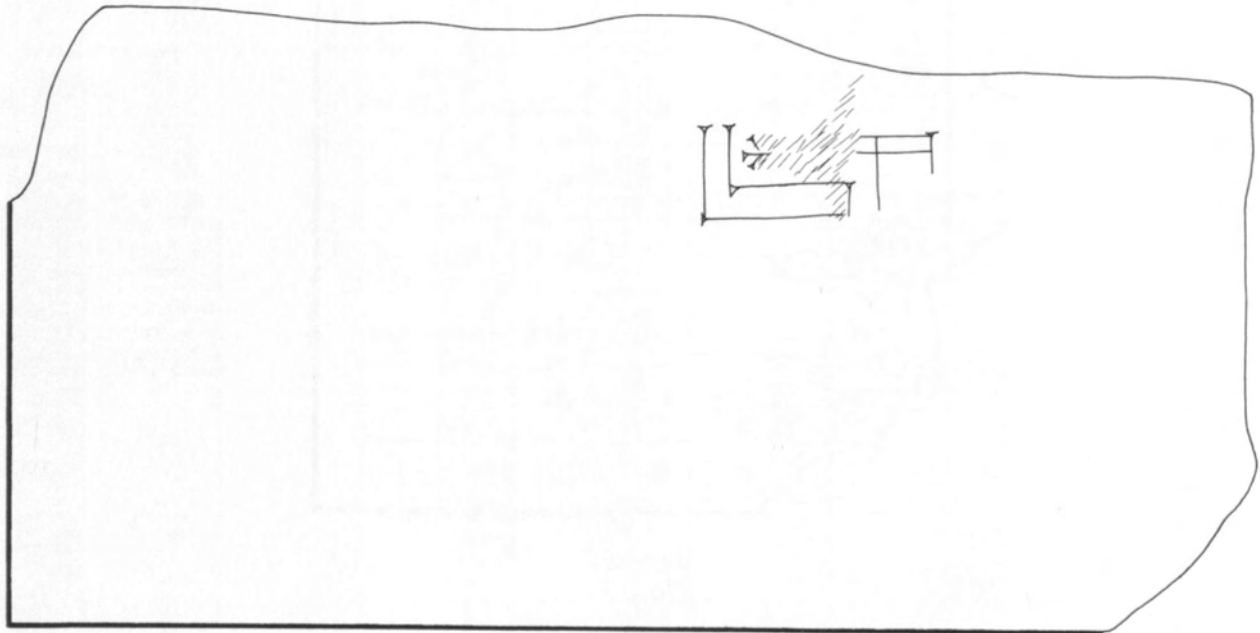

Reverse
No. 14

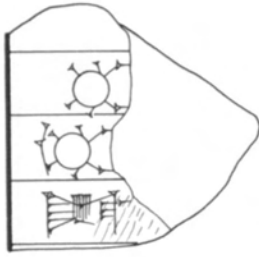

No. 15

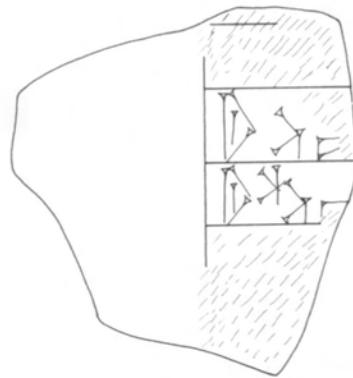

No. 16

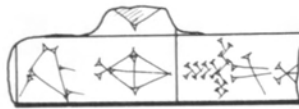

No. 17



Reverse
No. 18

PLATE 10

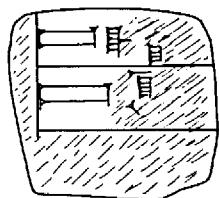

No. 19

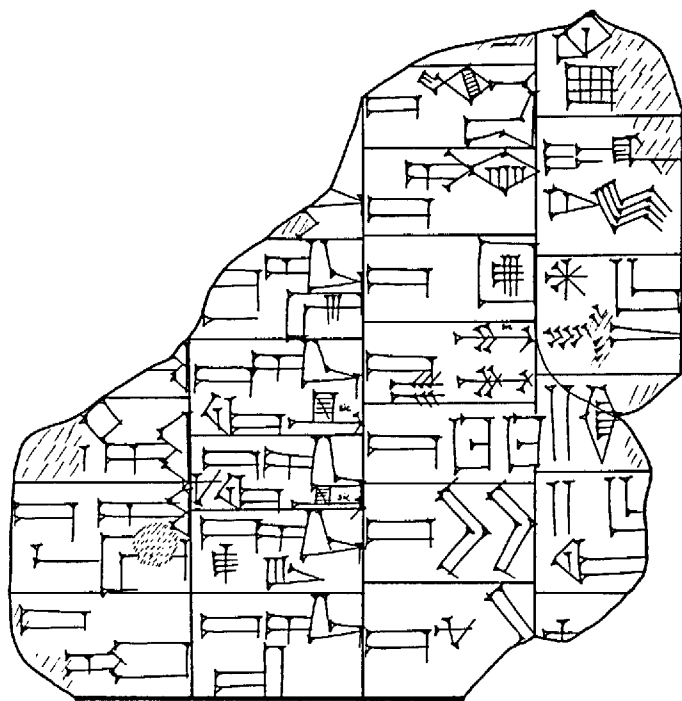

No. 20

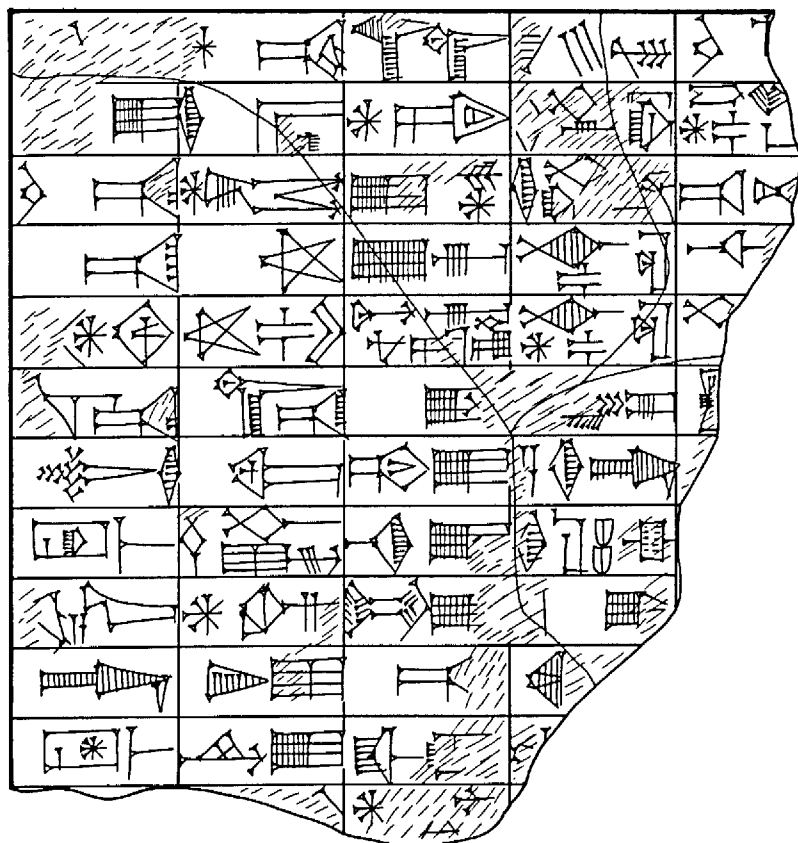

No. 21

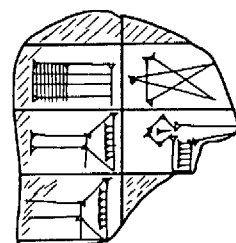

No. 22



No. 23

PLATE 12

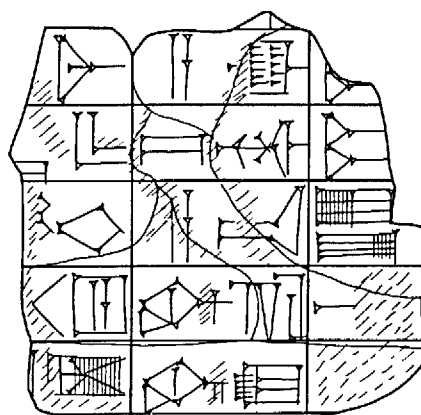

No. 24

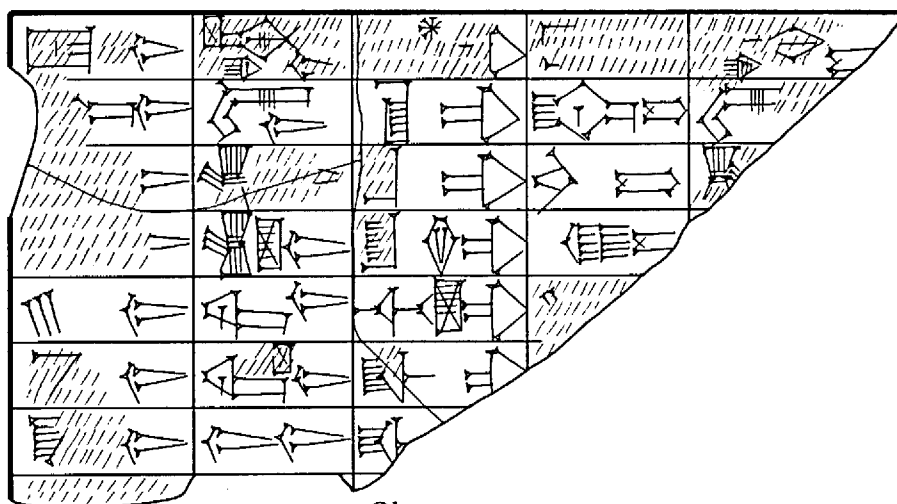

Obverse
No. 25

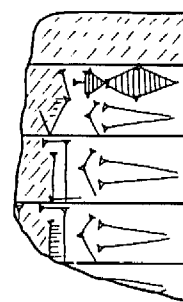

No. 26

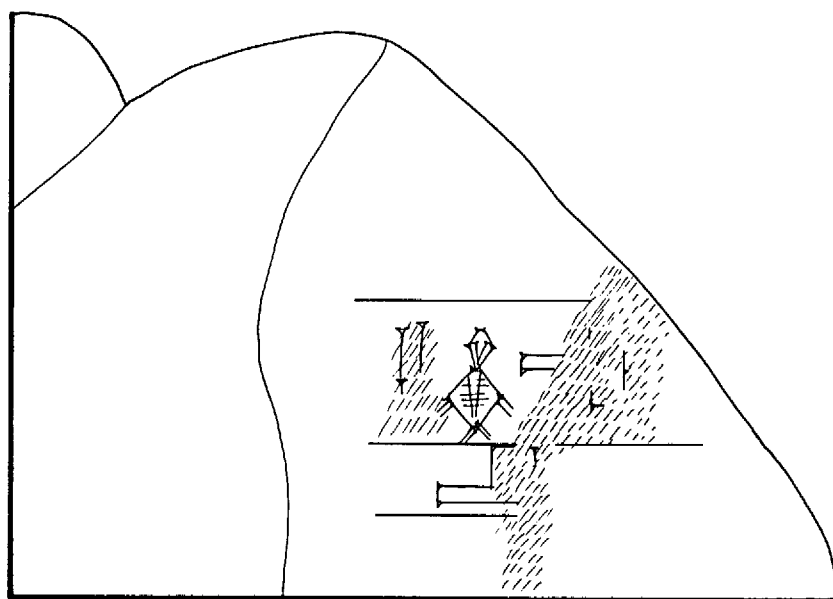

Reverse
No. 25

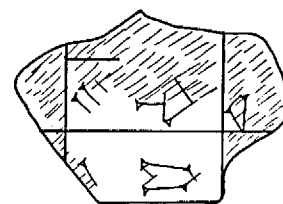

No. 27

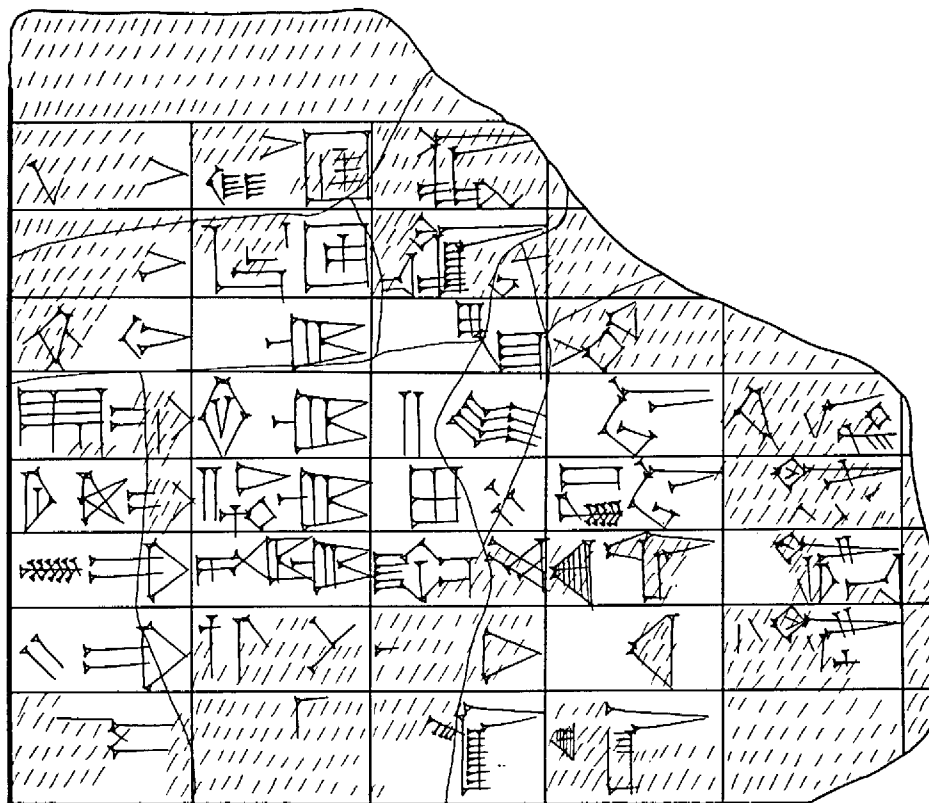

Obverse
No. 28

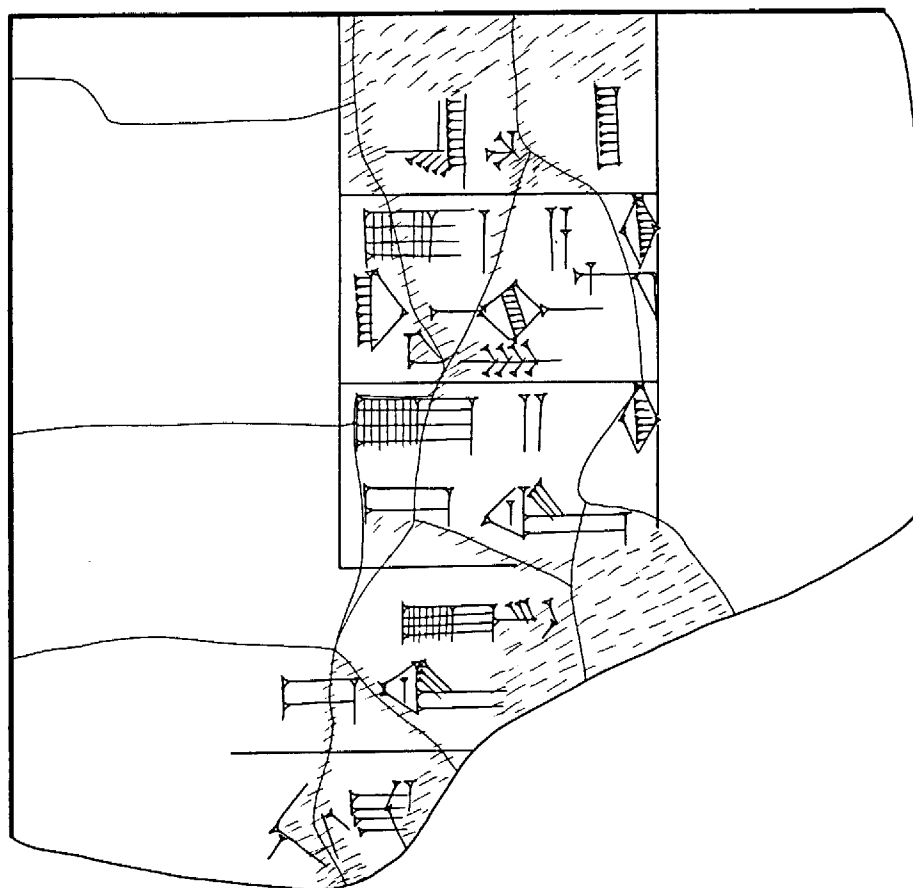

Reverse
No. 28

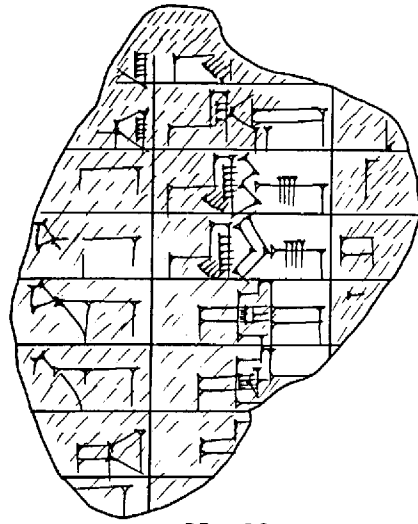

No. 29

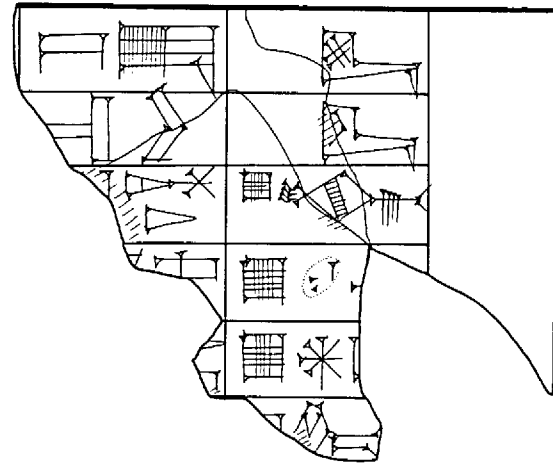

No. 30

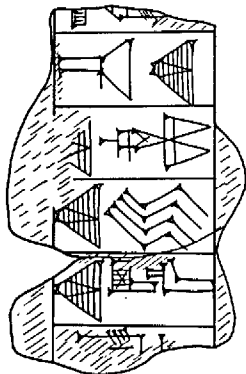

No. 31

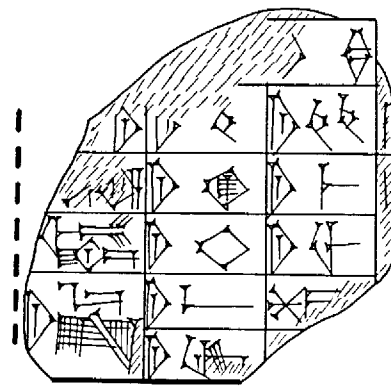

No. 32

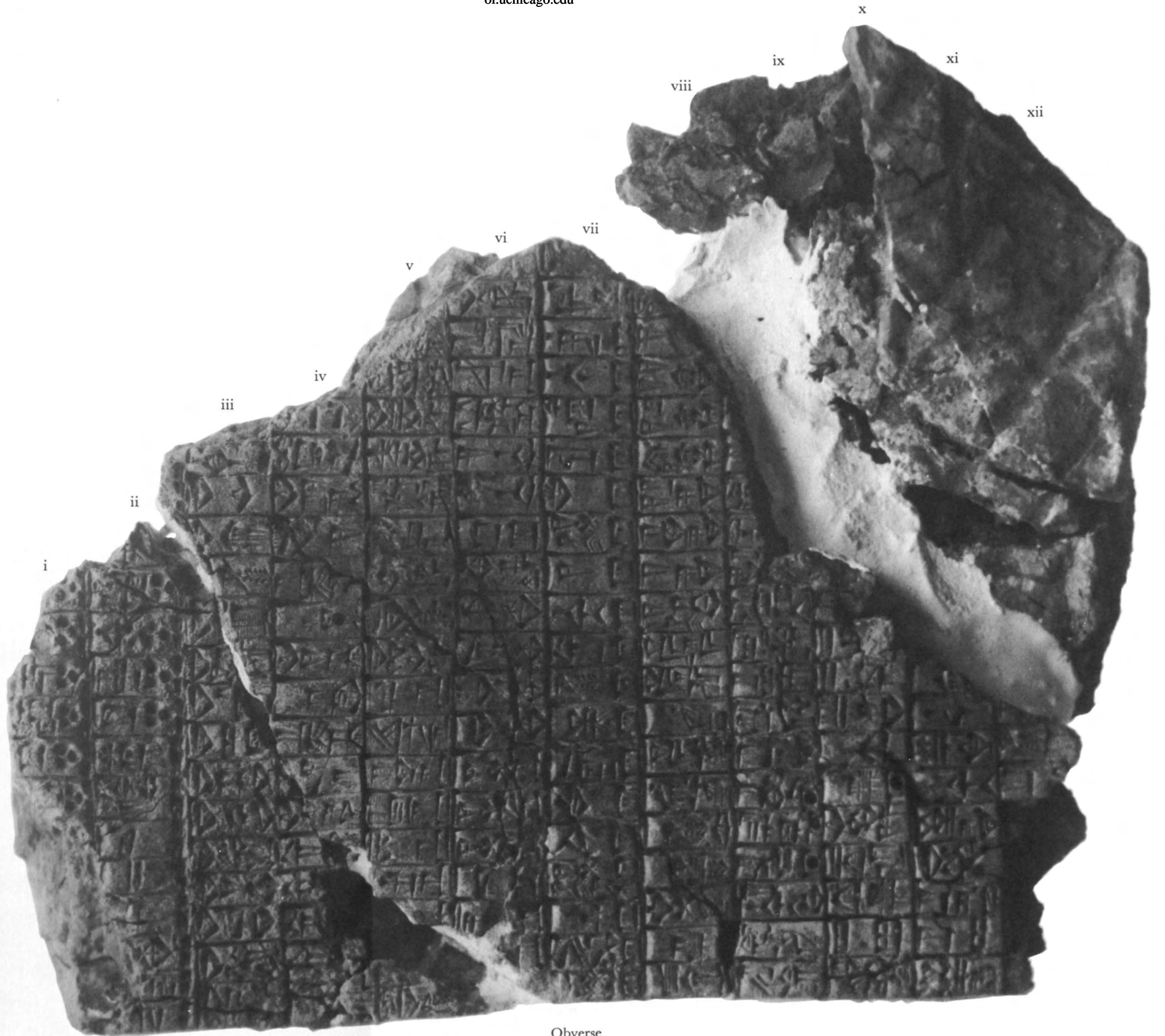

Obverse
No. 33

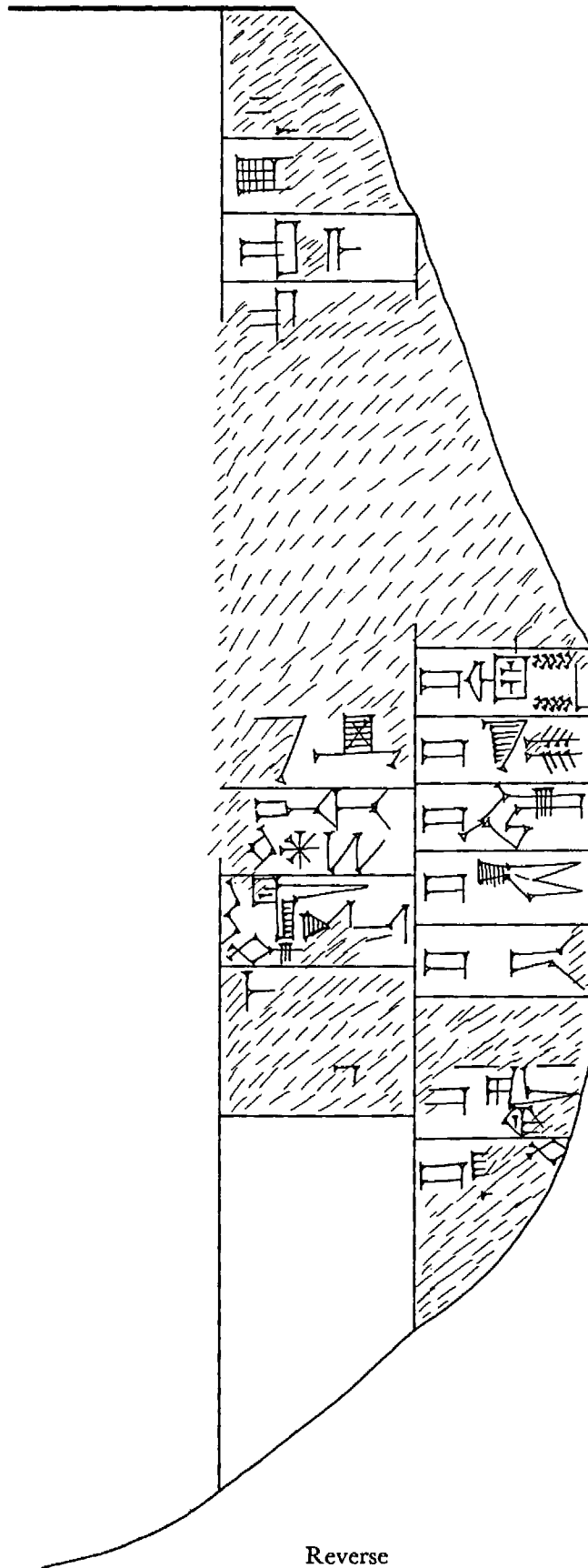

Reverse
No. 33

PLATE 17

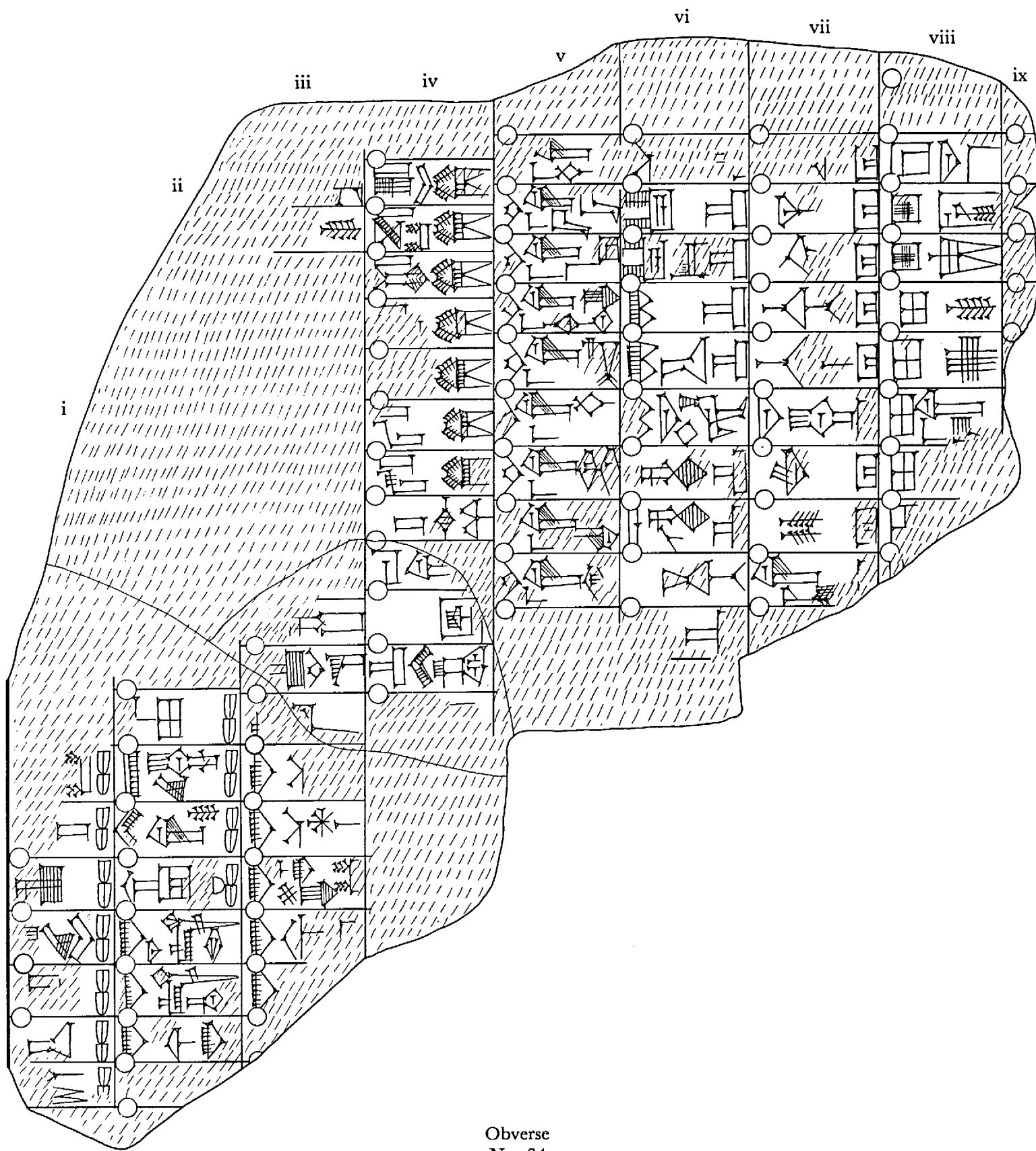

Obverse
No. 34

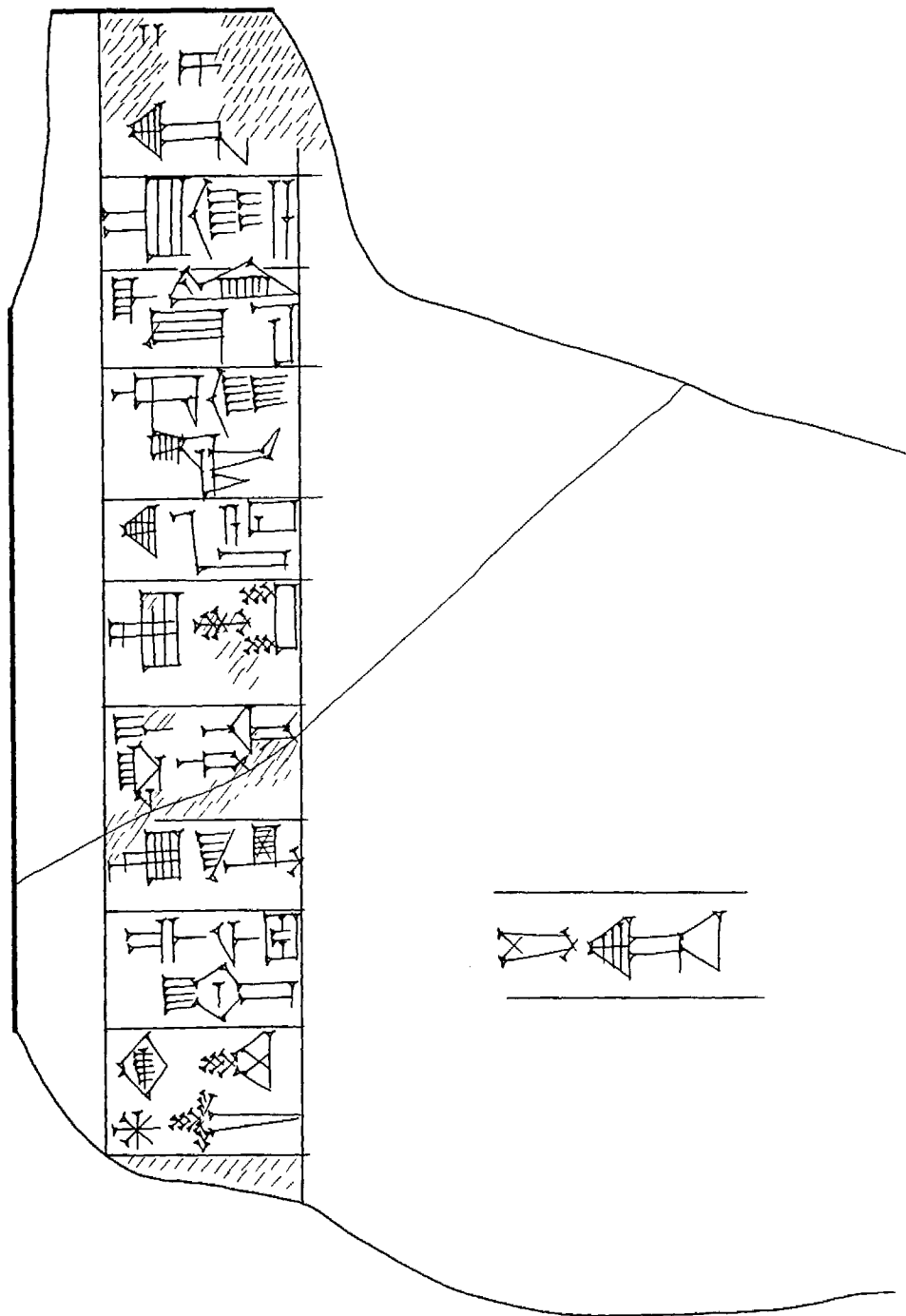

Reverse
No. 34

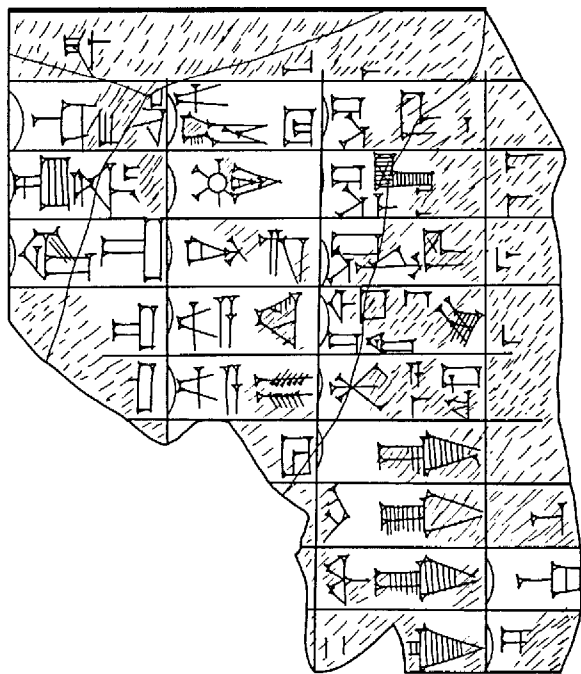

No. 35

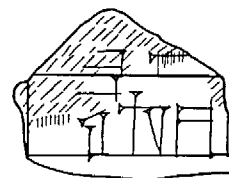

No. 36

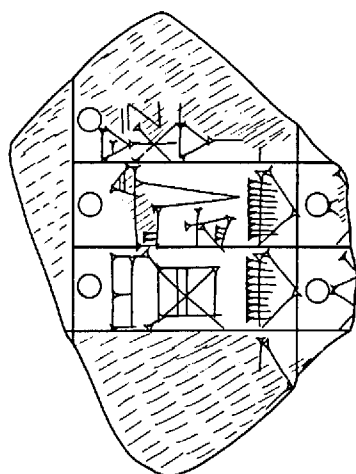

No. 37

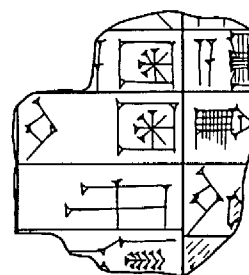

No. 38

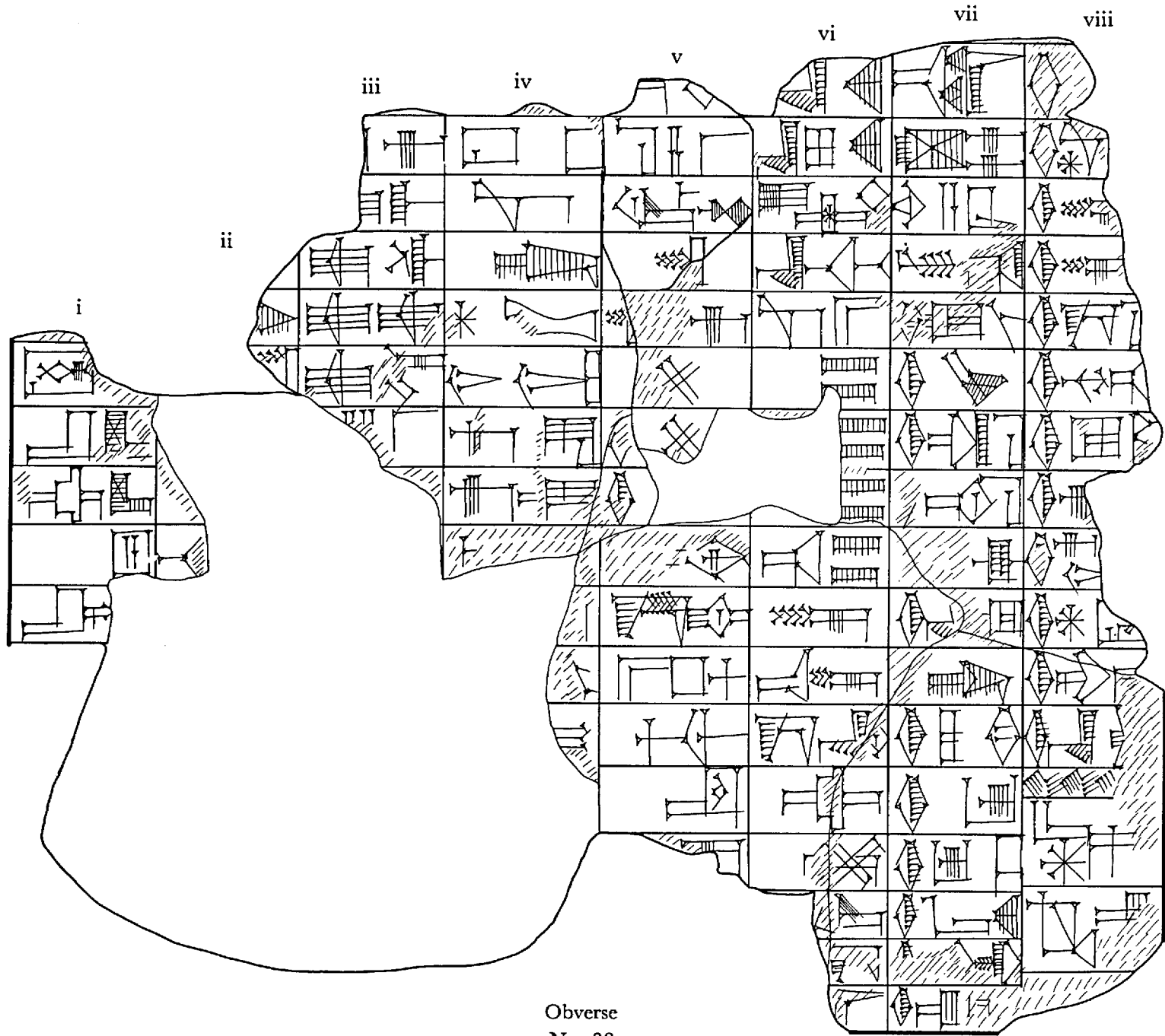

Obverse
No. 39

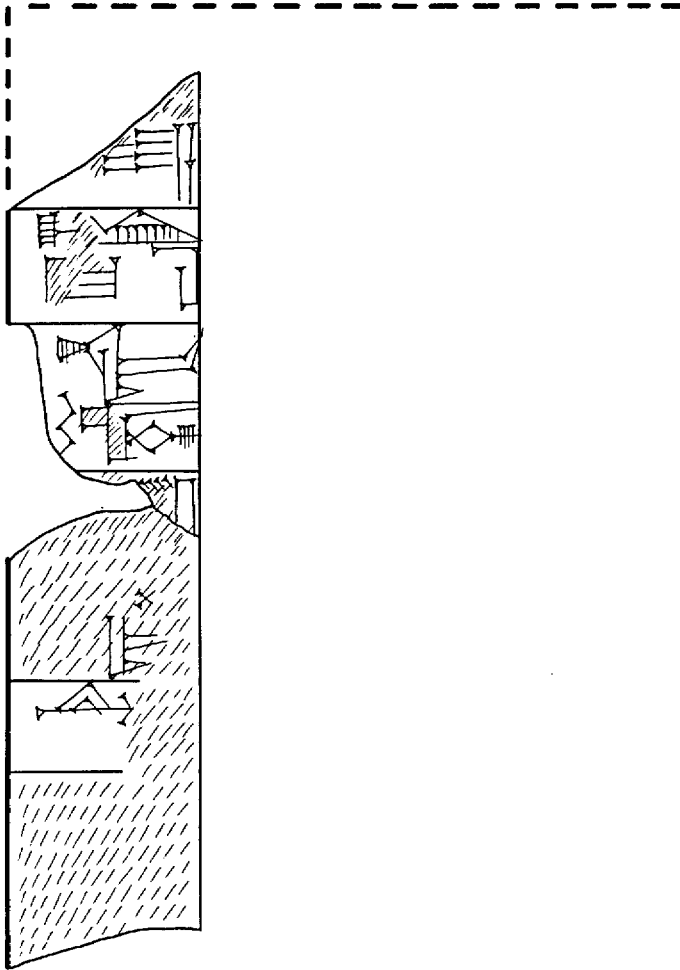

Reverse
No. 39

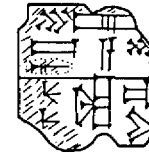

No. 40

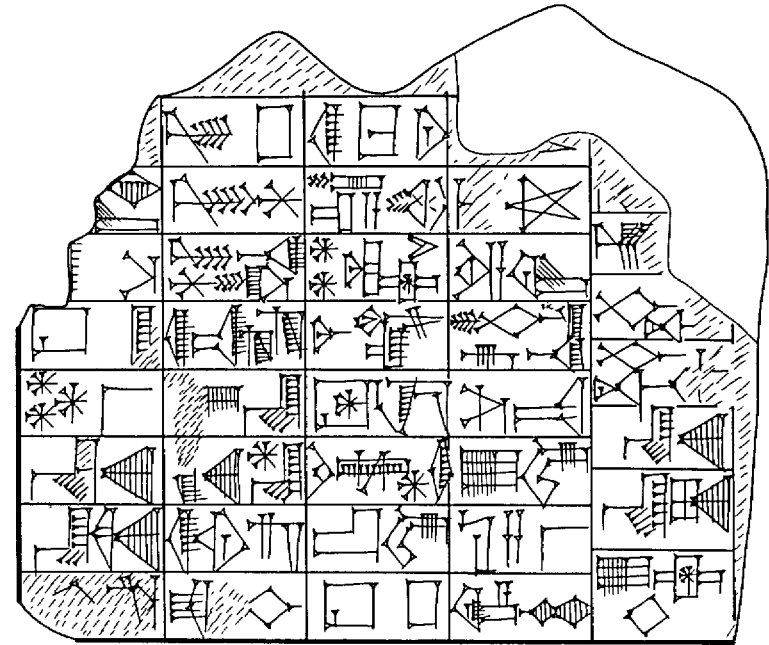

No. 41

PLATE 22

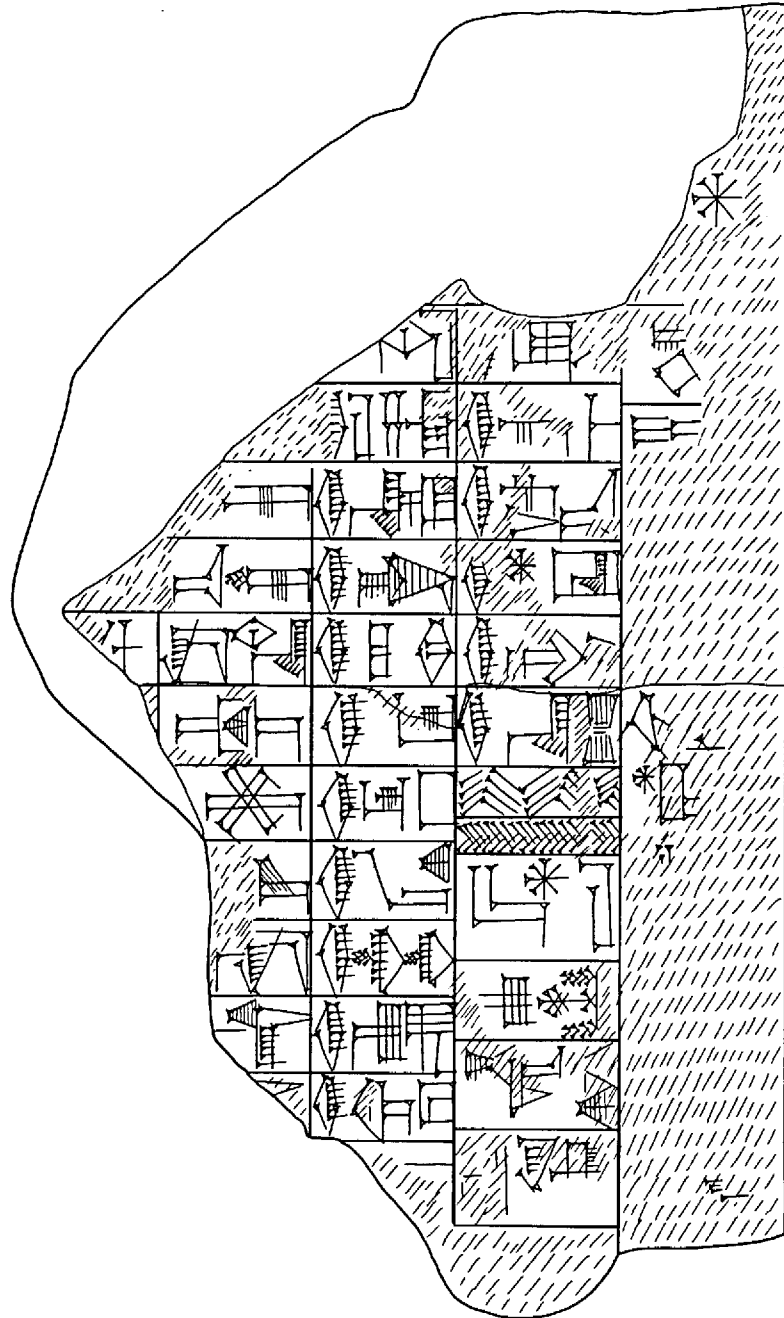

No. 42

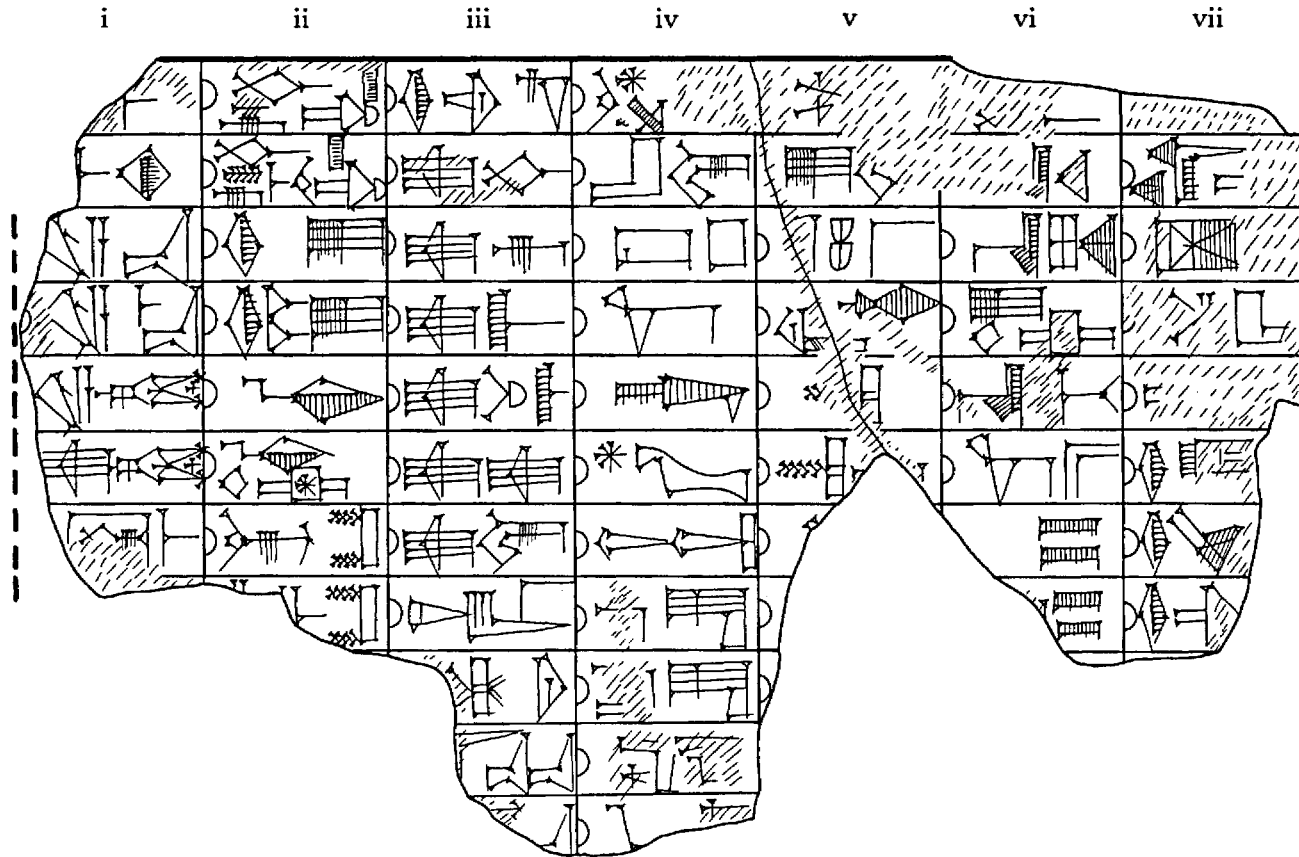

Obverse
No. 43

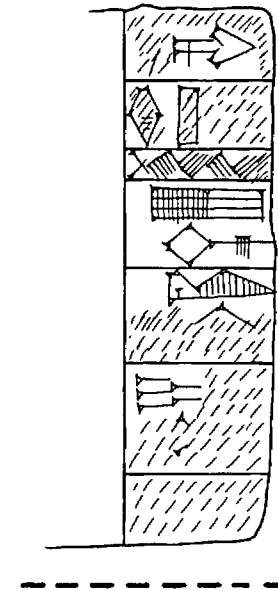

Reverse
No. 43

PLATE 24

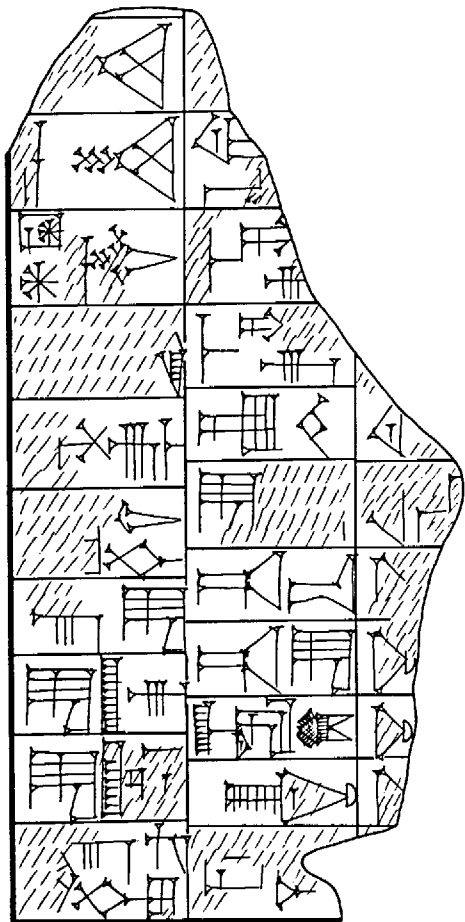

No. 44

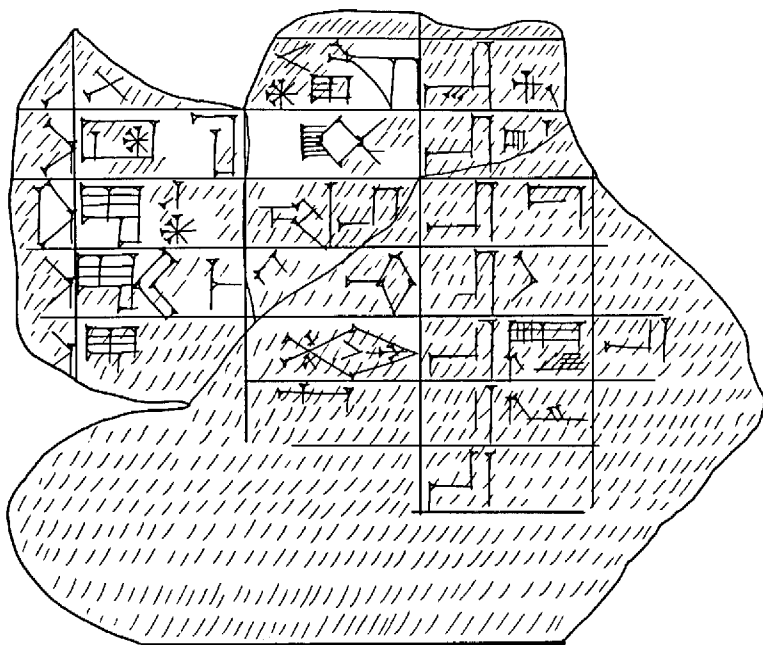

No. 45

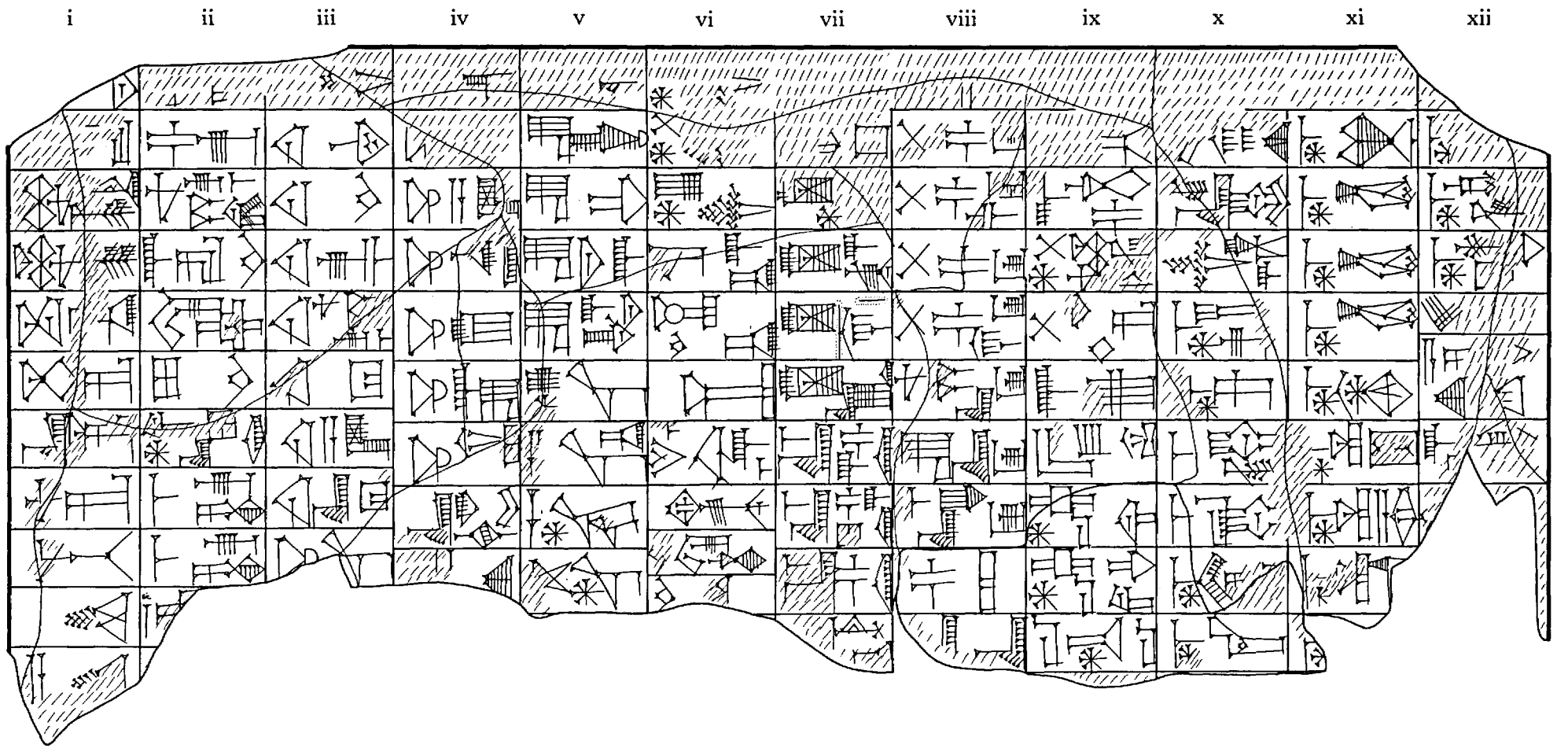

No. 46

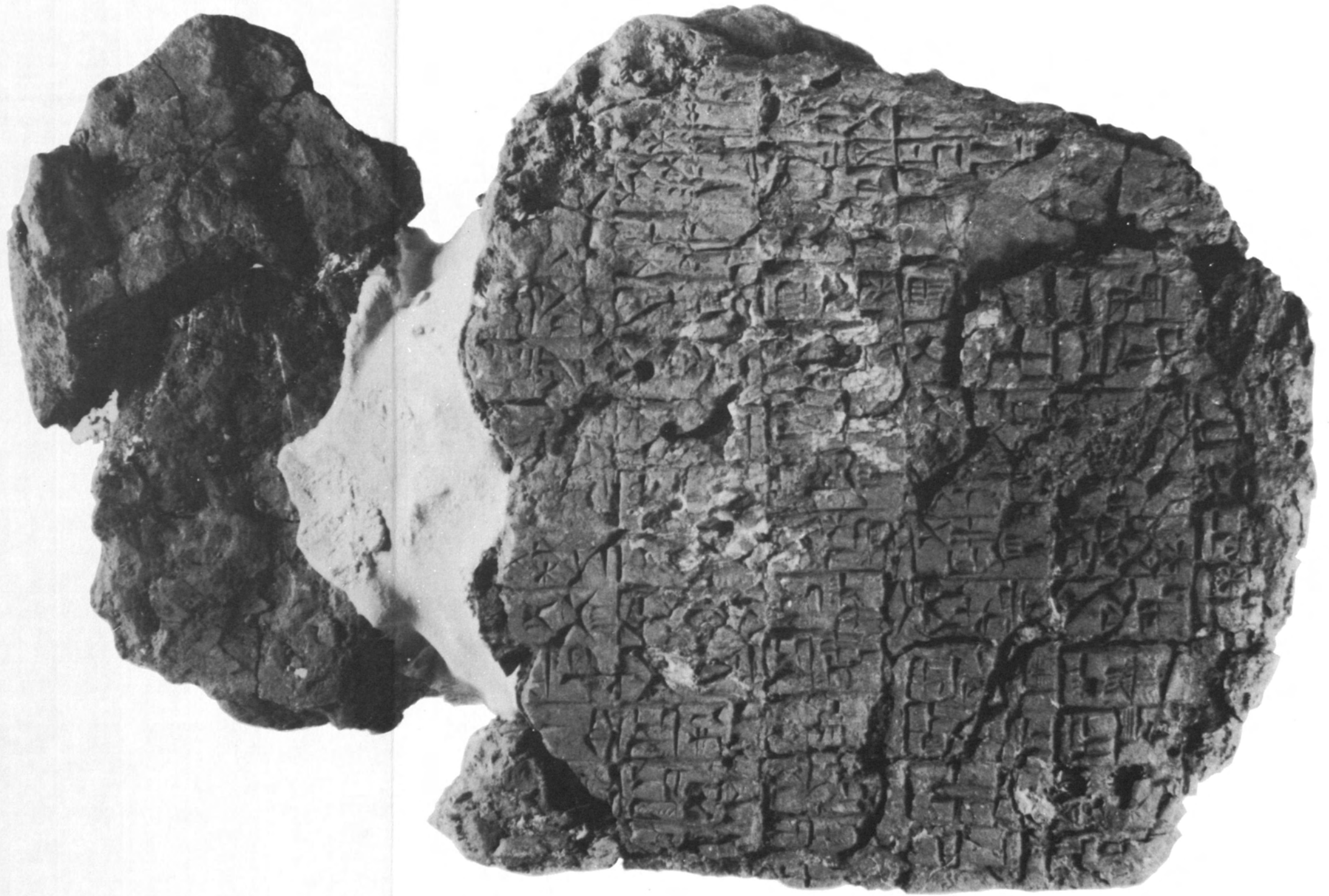

Obverse
No. 47



Reverse
No. 47

PLATE 28

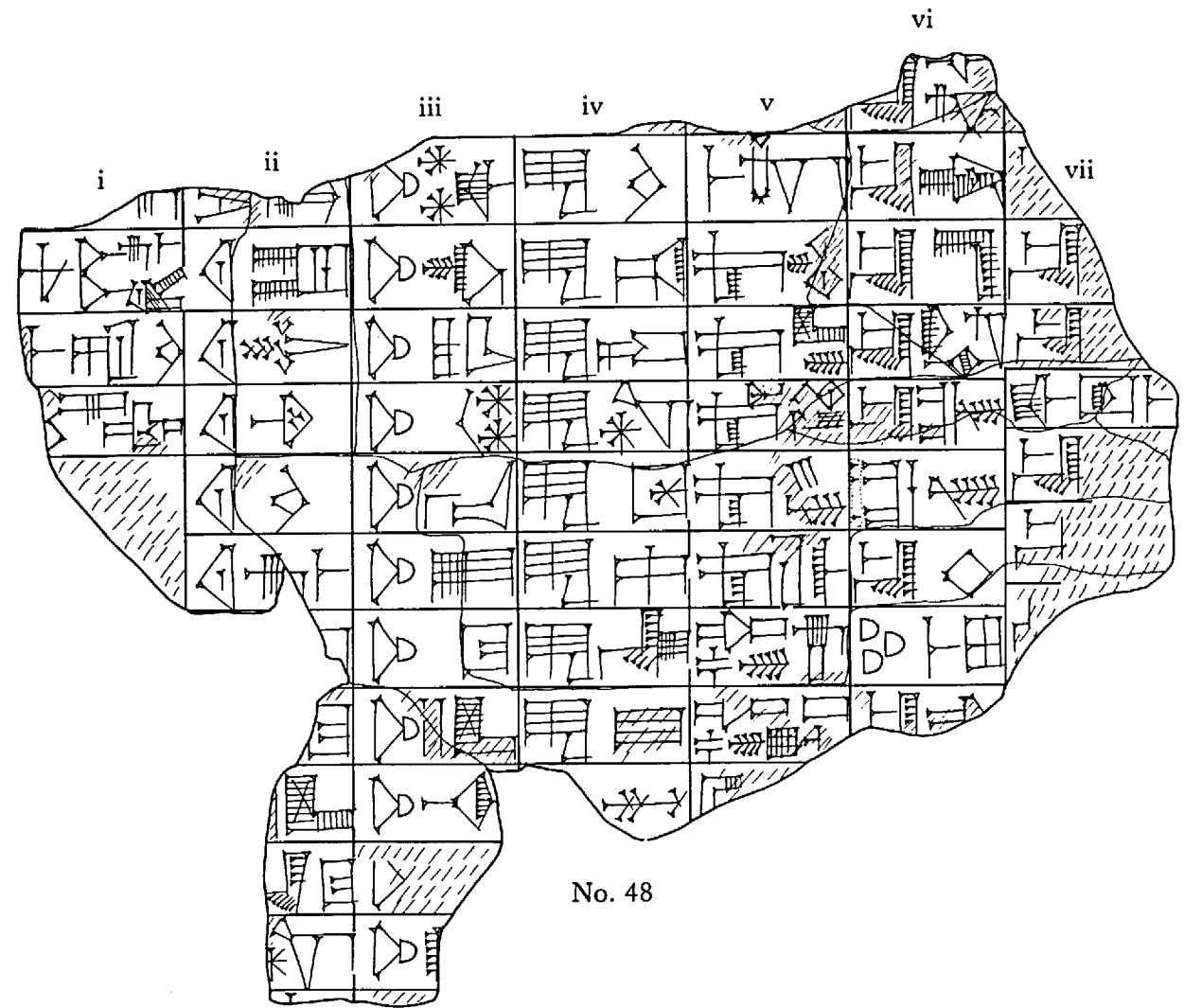

No. 48

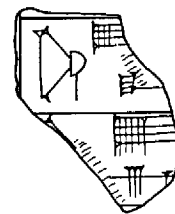

No. 49

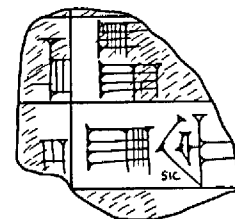

No. 50

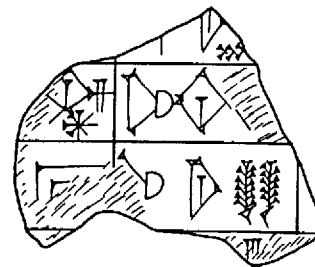

No. 51

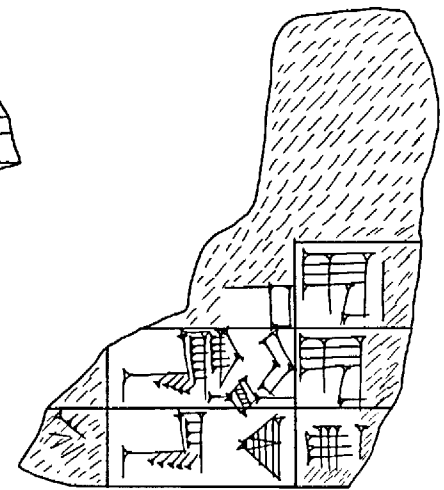

No. 52

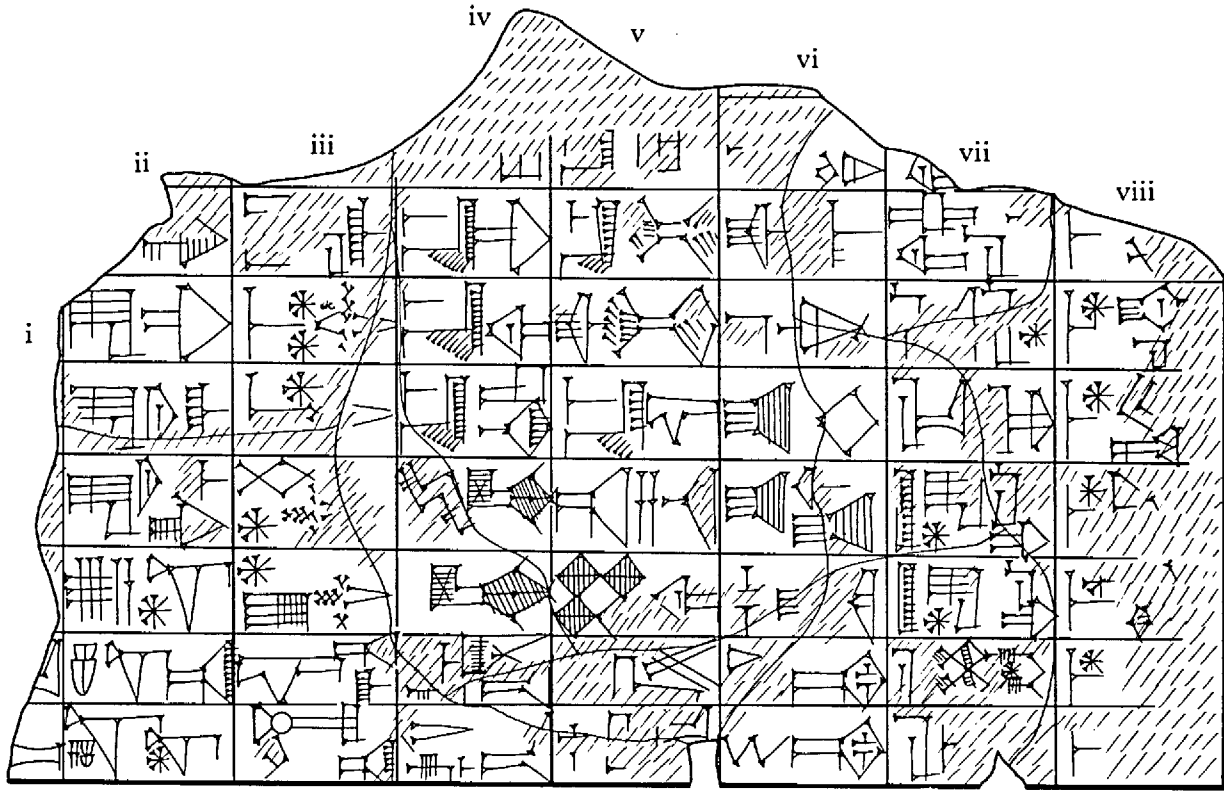

Obverse
No. 53

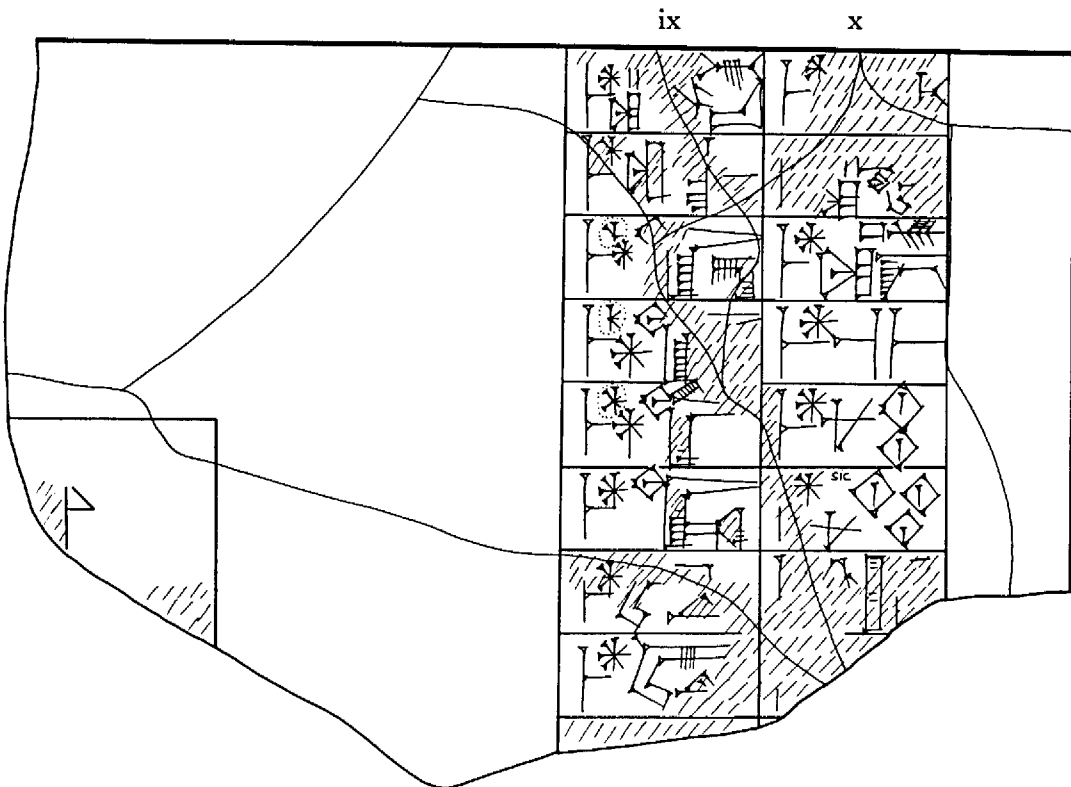

Reverse
No. 53

PLATE 30

1-11

22-33

43-59

64-84

85-105

107-26

128-45

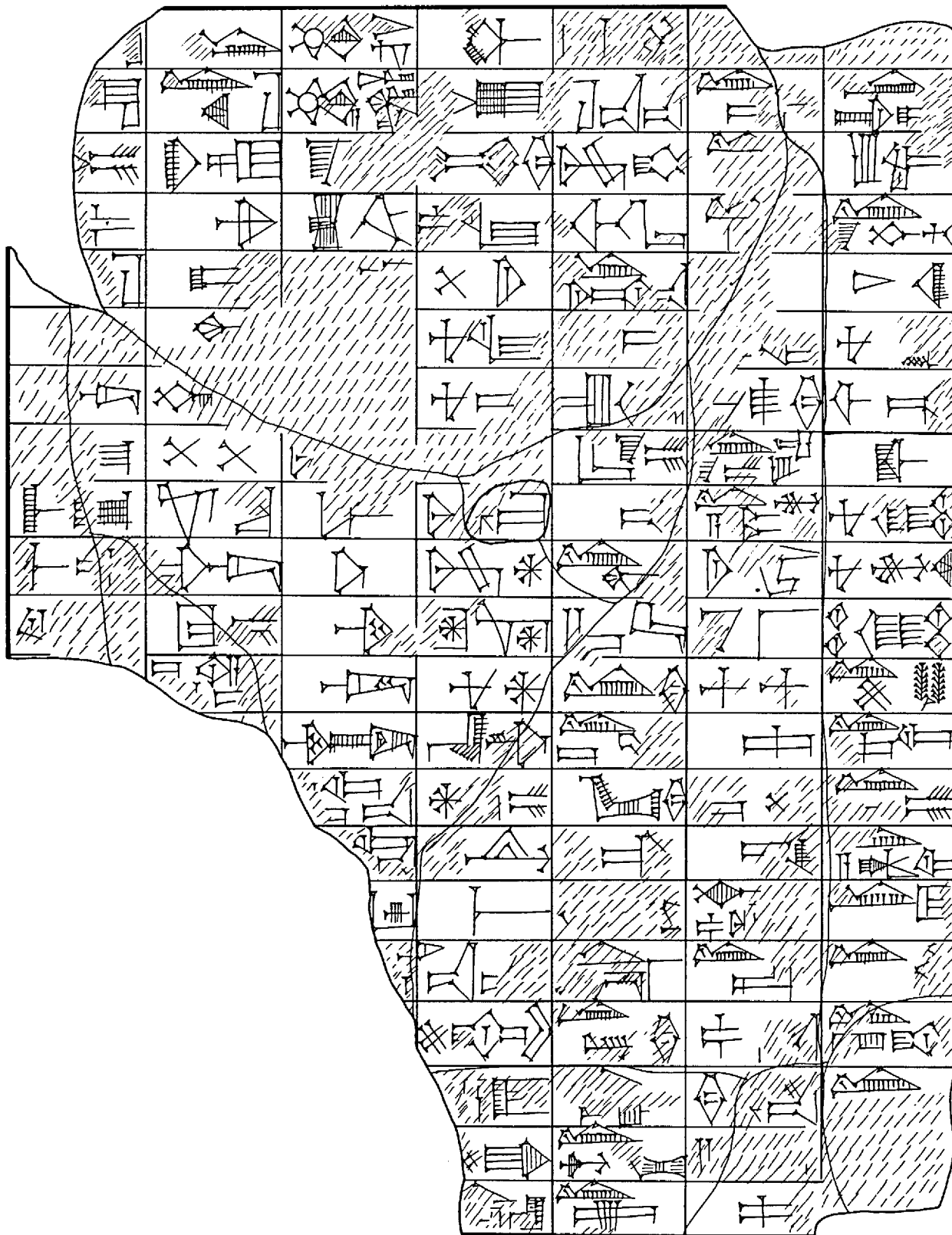

No. 54

25-46 49-69

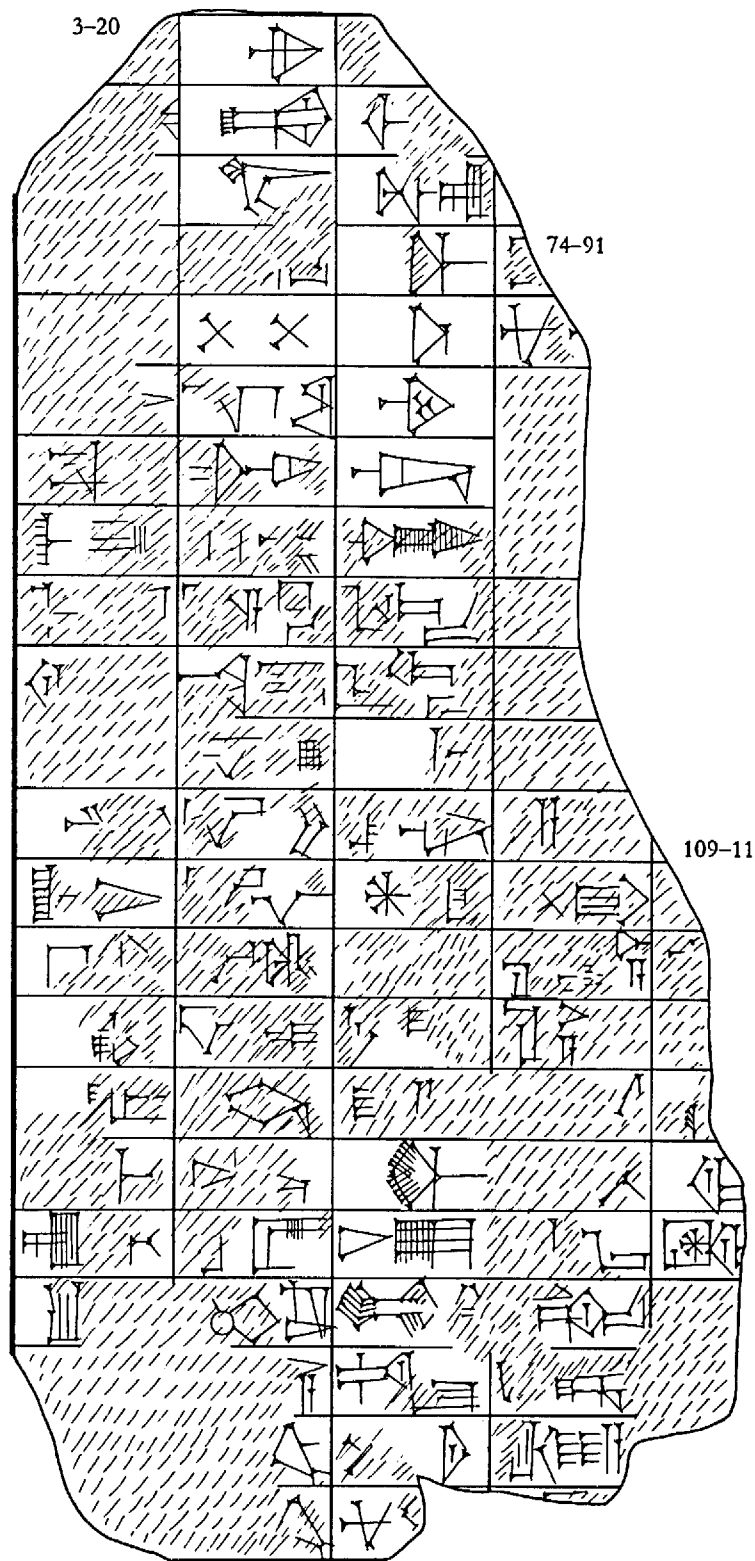

No. 55

218-20

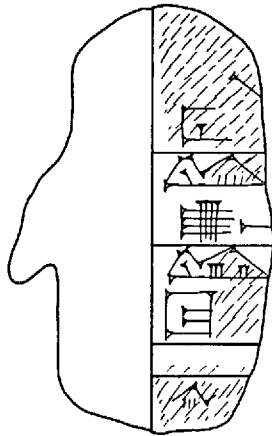

No. 56

170-83

193-206

214-20

148-61

30-32

49-51

11

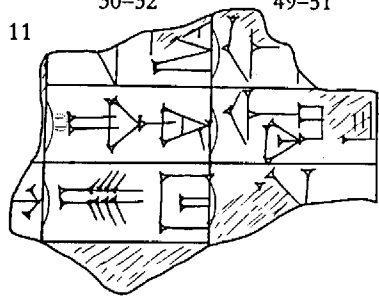

No. 57

131-38

170-71

151

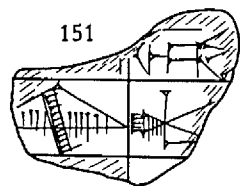

No. 58

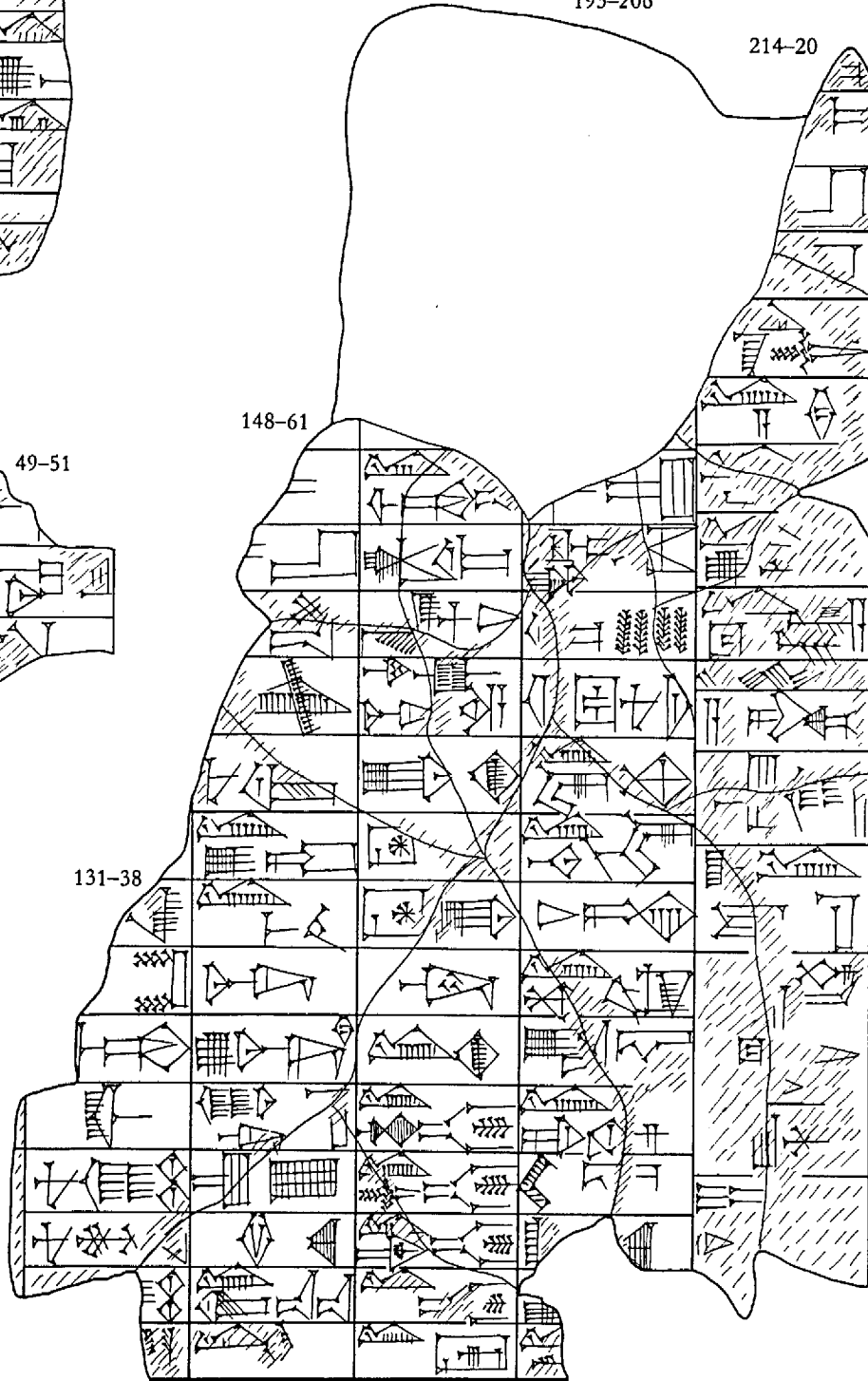

No. 59

PLATE 33

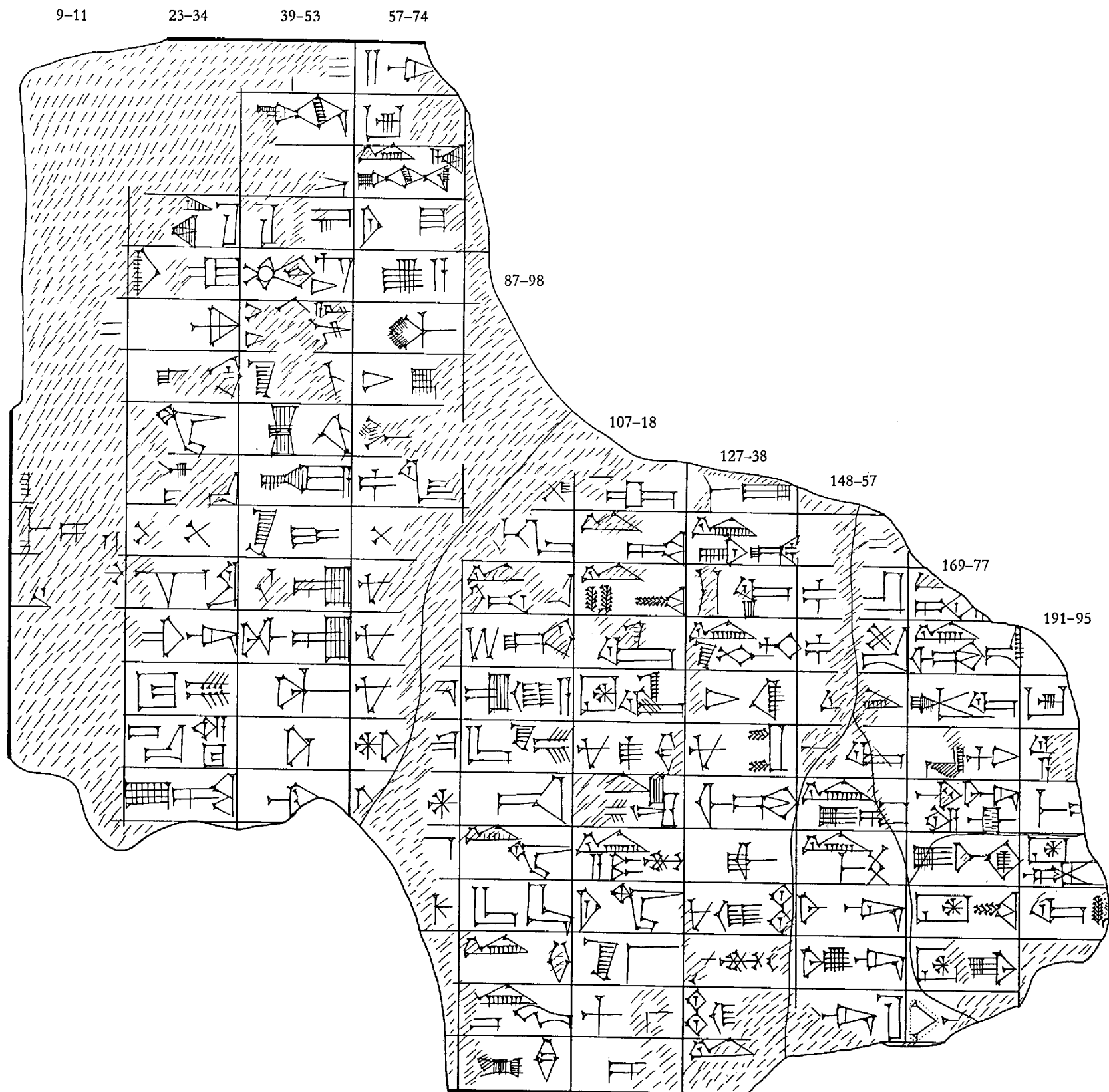

Obverse
No. 60

200-207

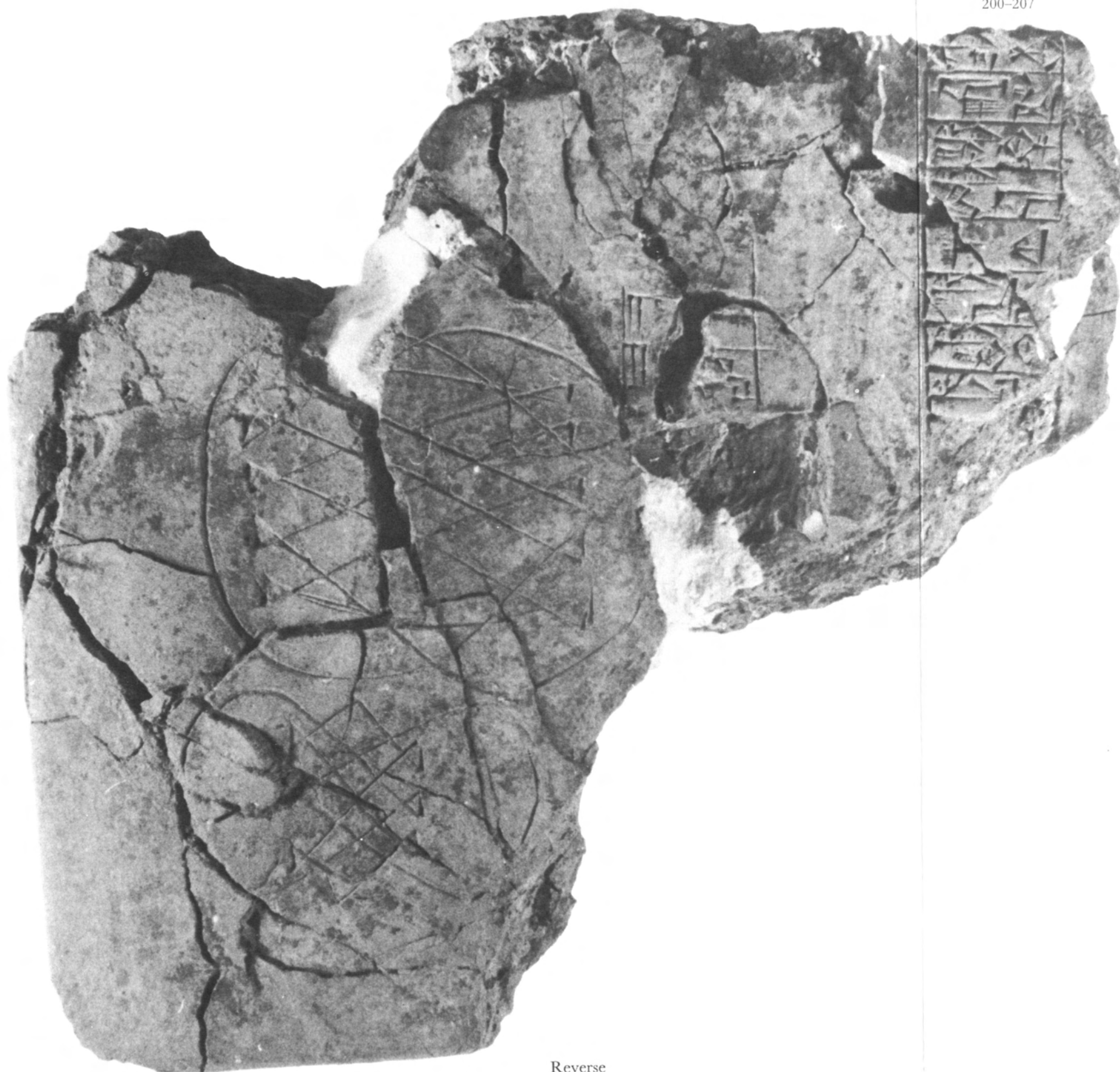

Reverse
No. 60



Obverse
No. 61

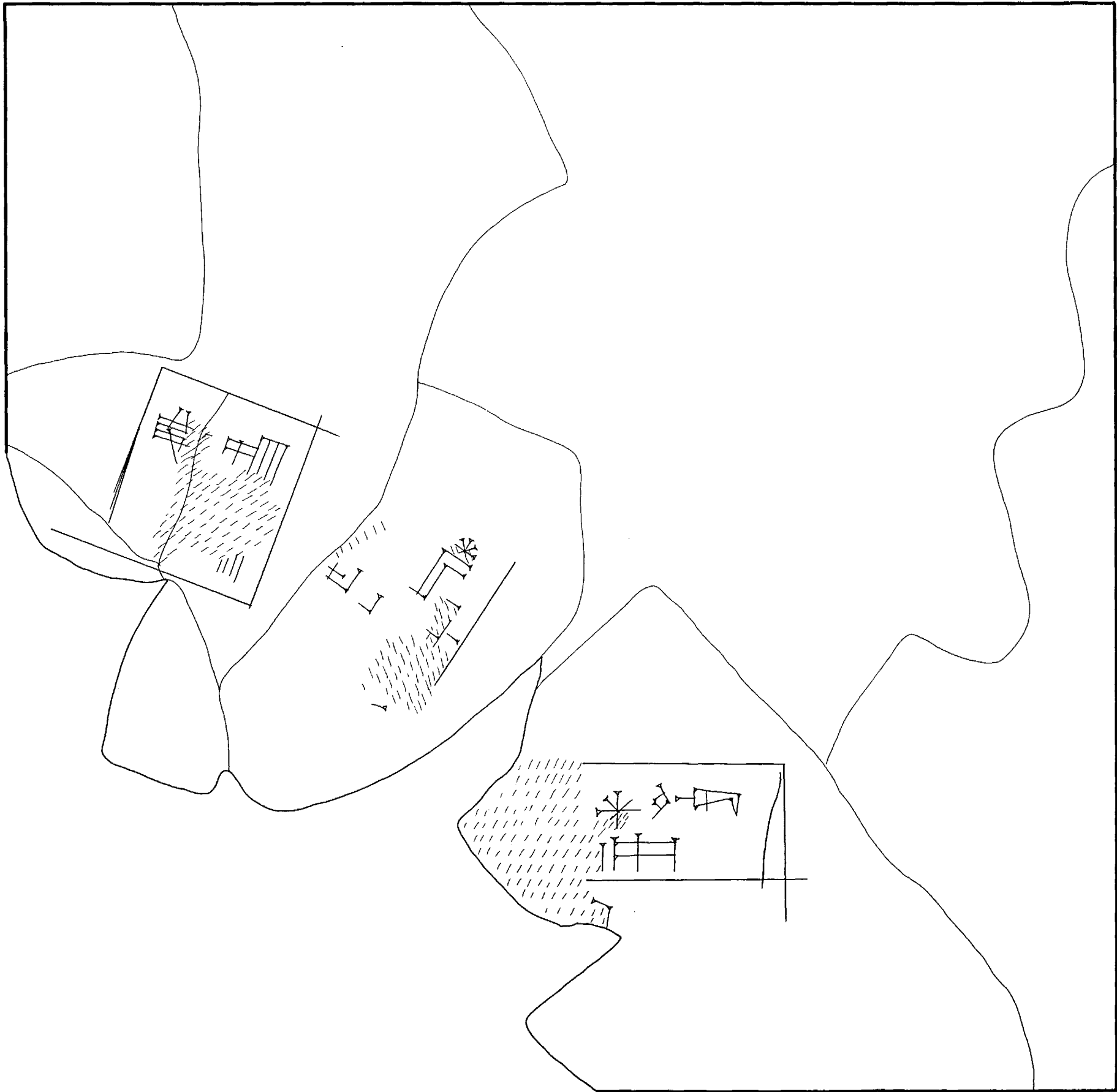

Reverse
No. 61

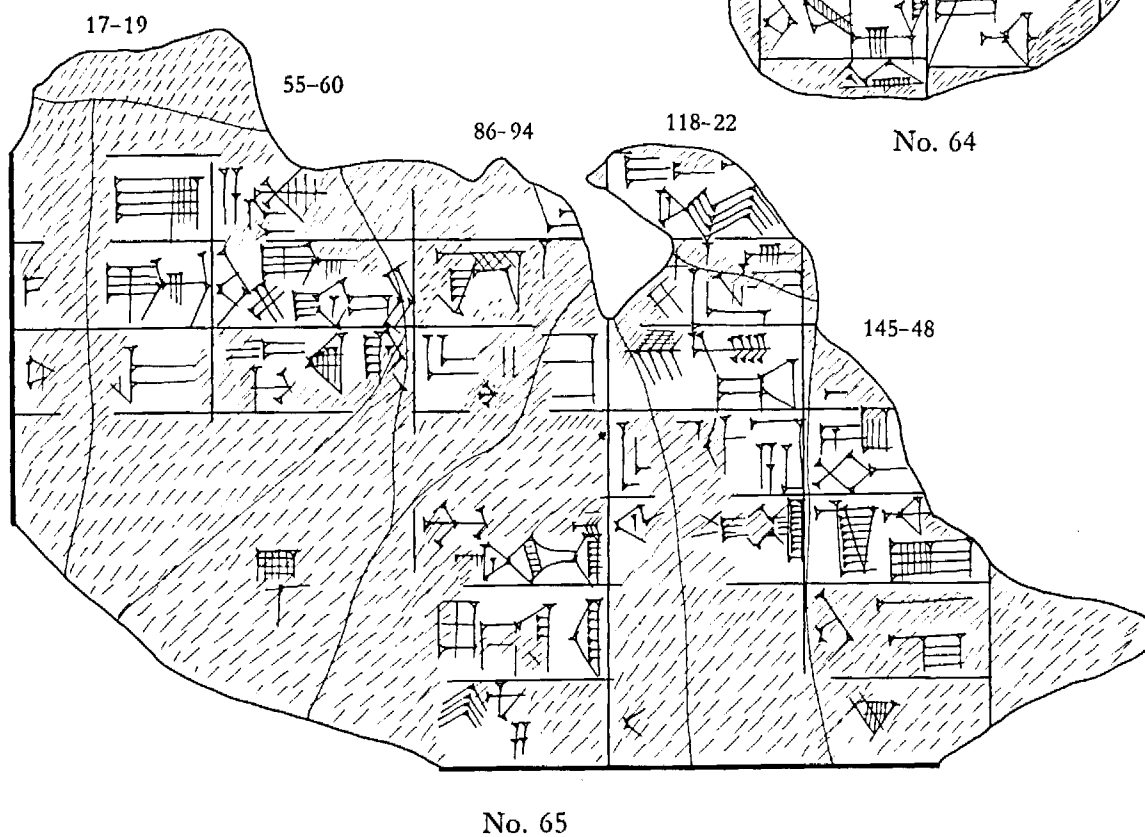
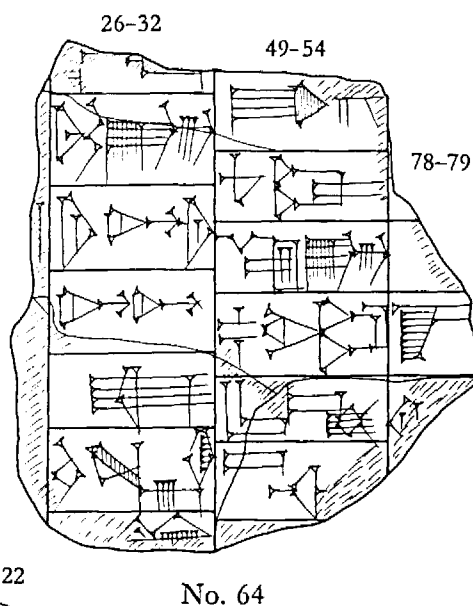
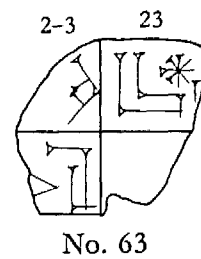
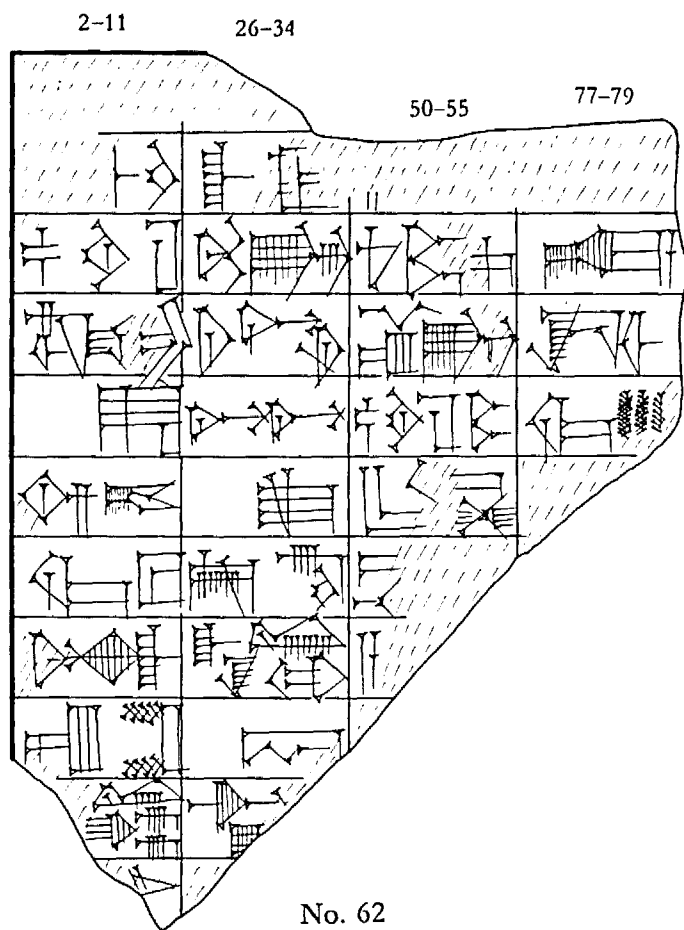

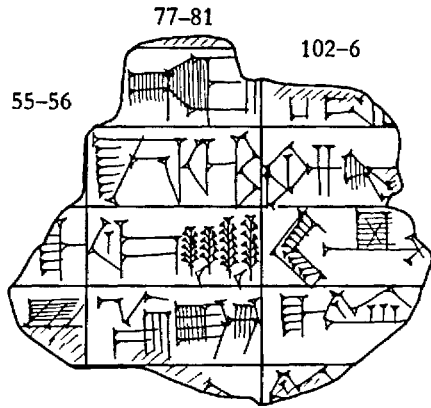

No. 66

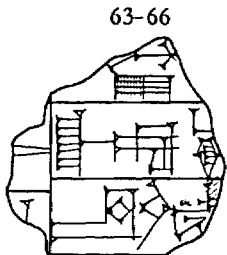

No. 67

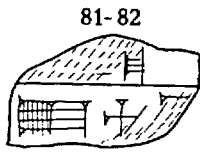

No. 68

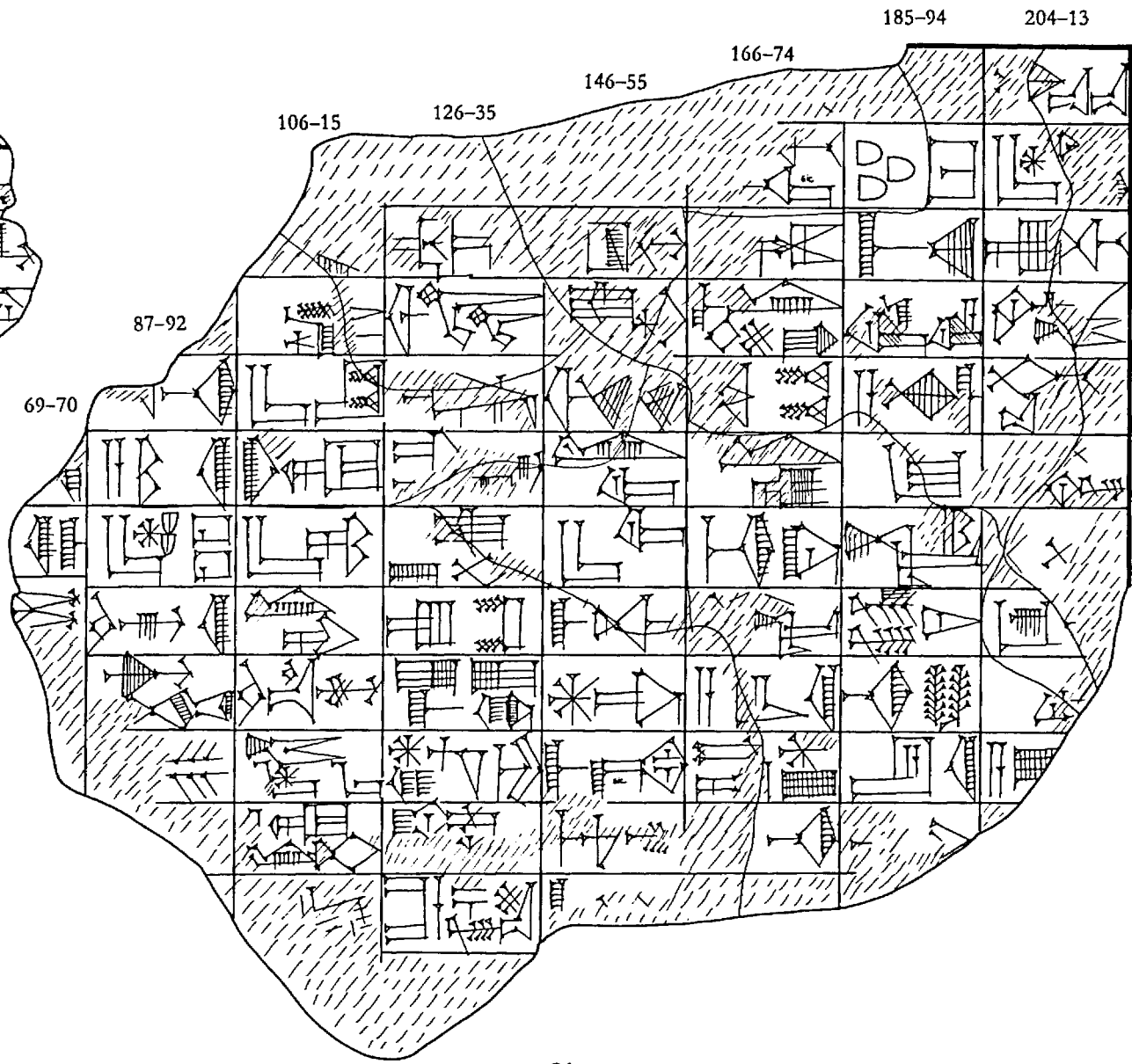

Obverse
No. 69

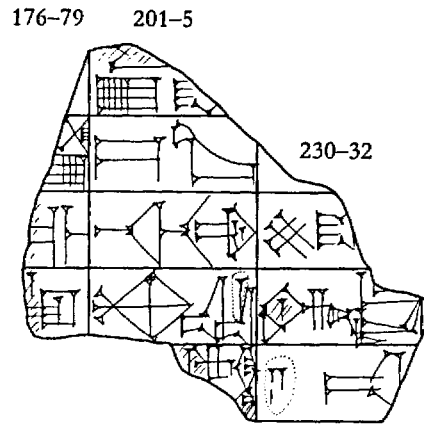

No. 70

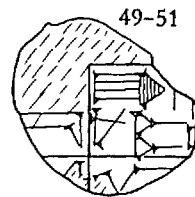

No. 71

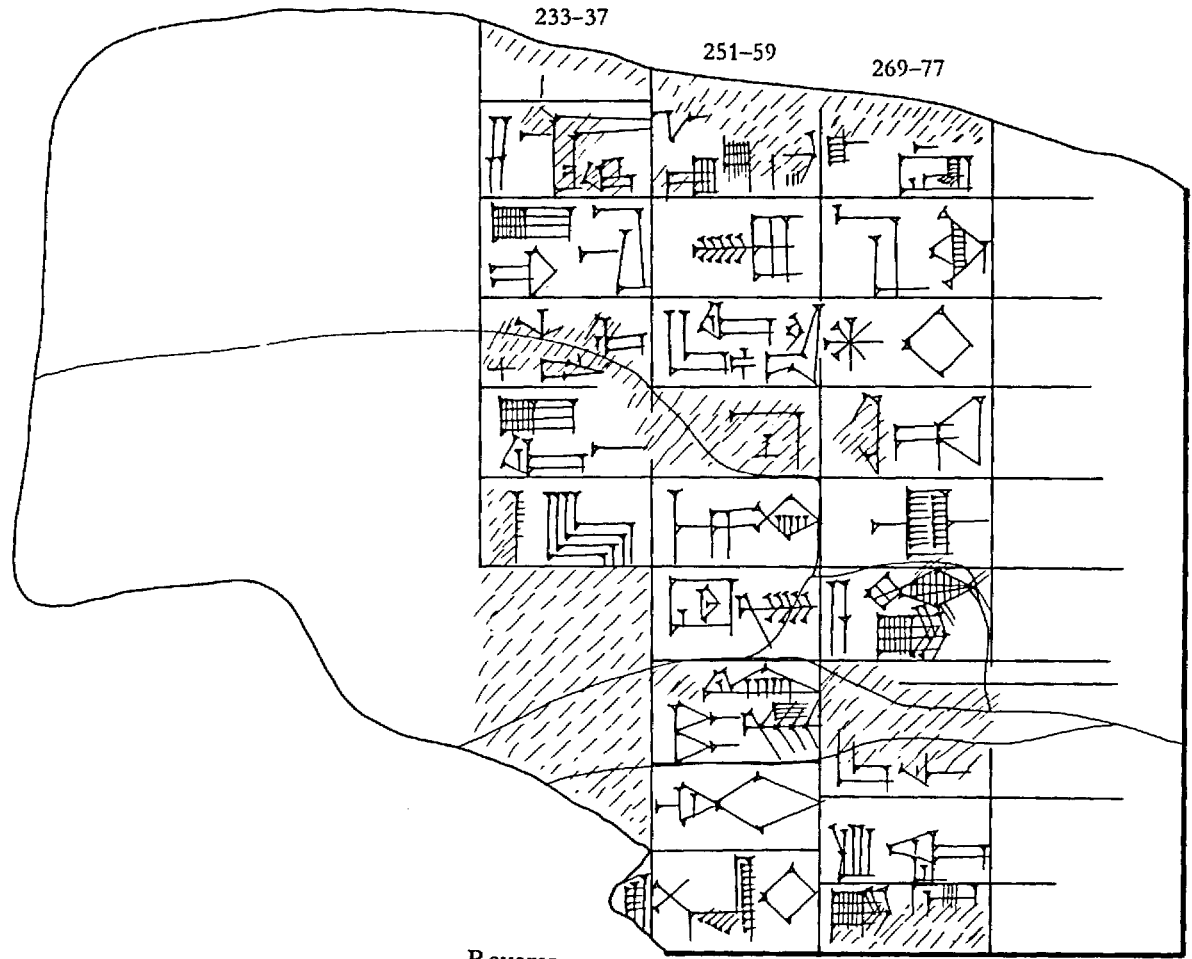

Reverse
No. 69

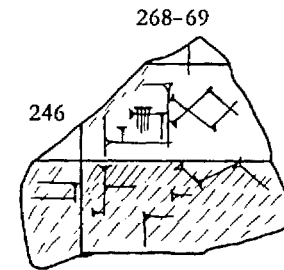

No. 72

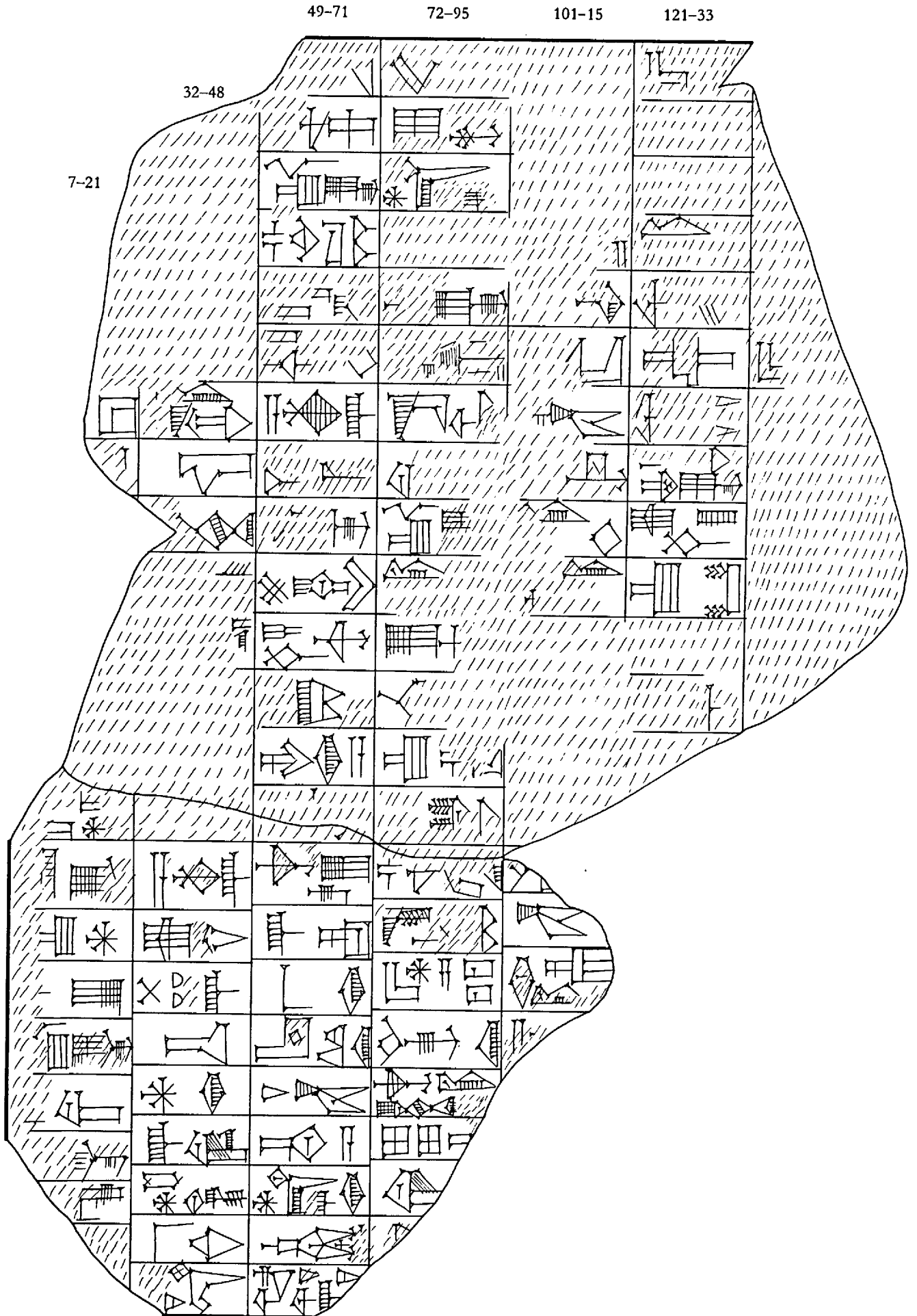

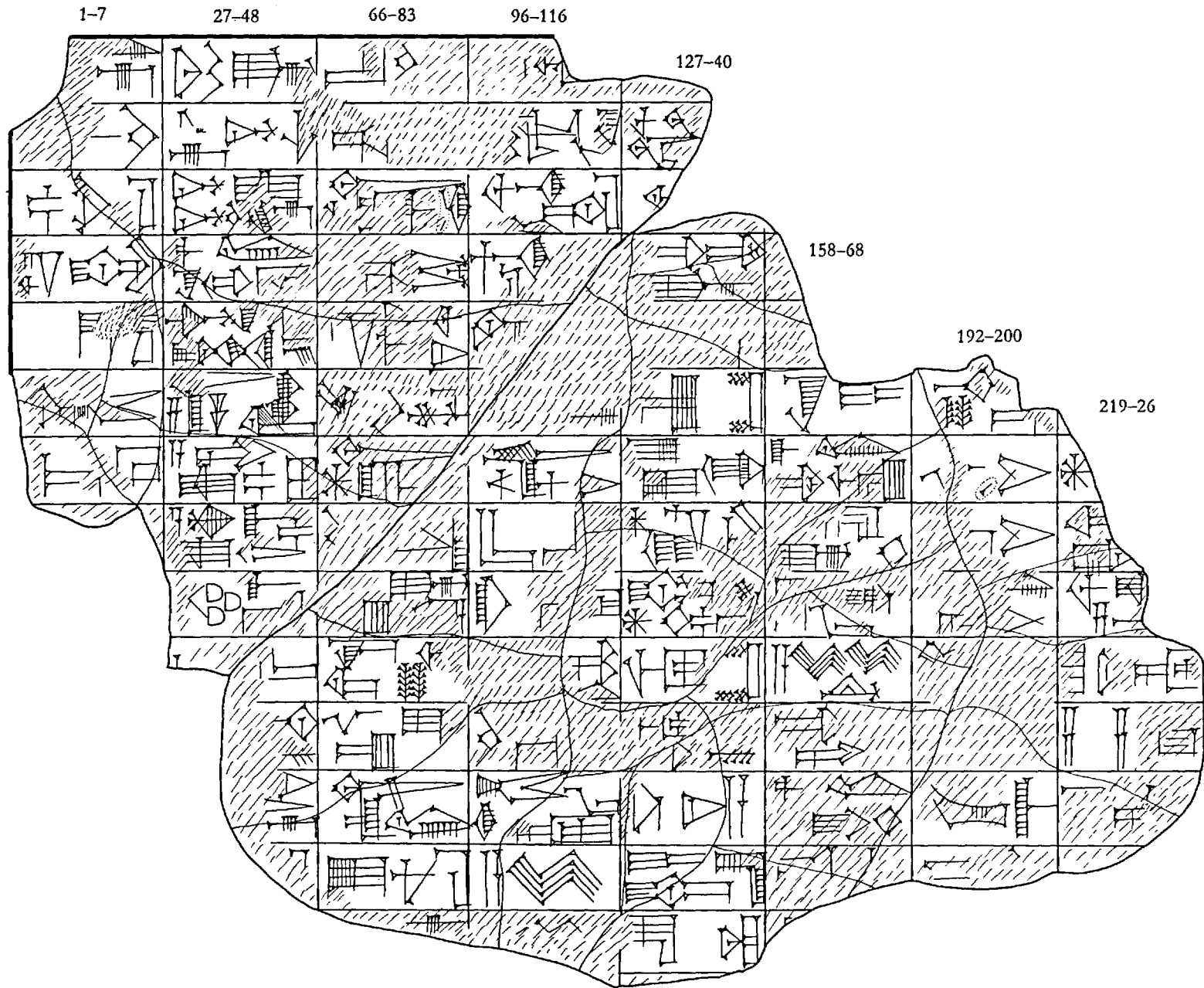

No. 74

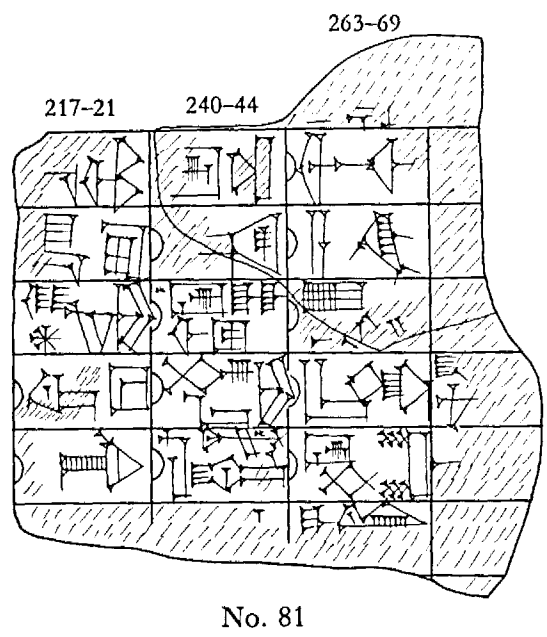
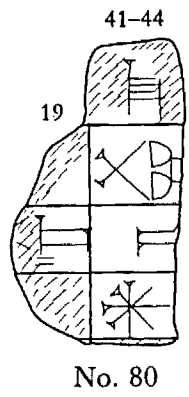
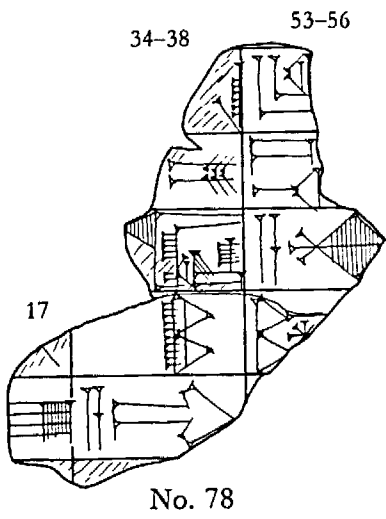
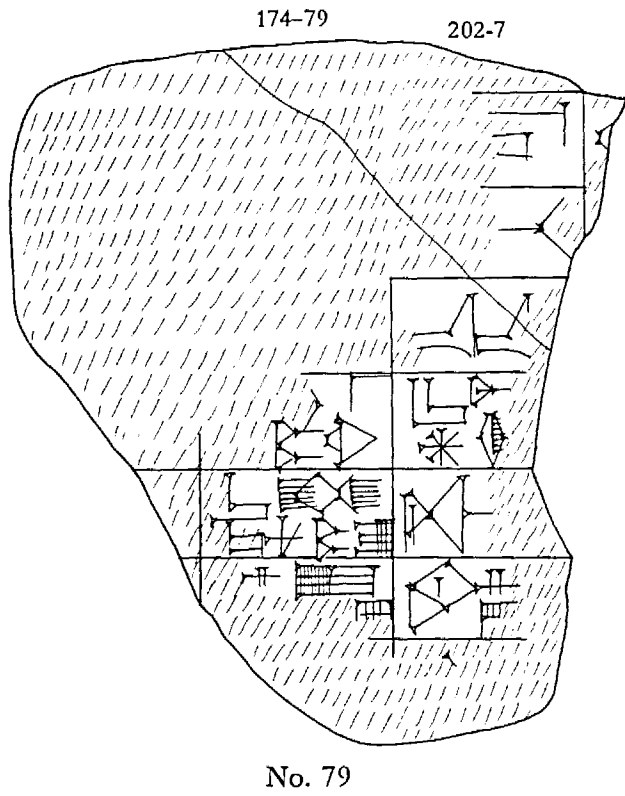
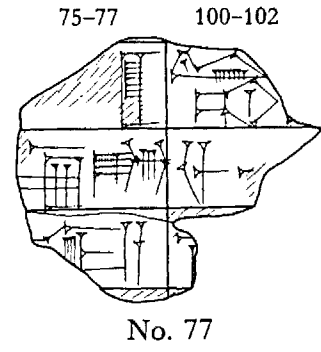
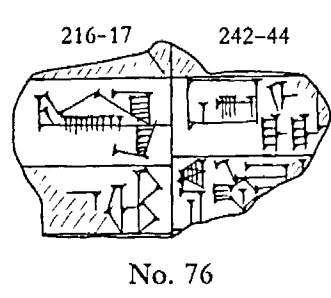
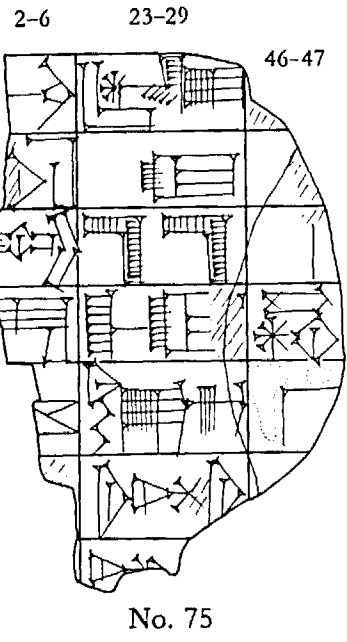

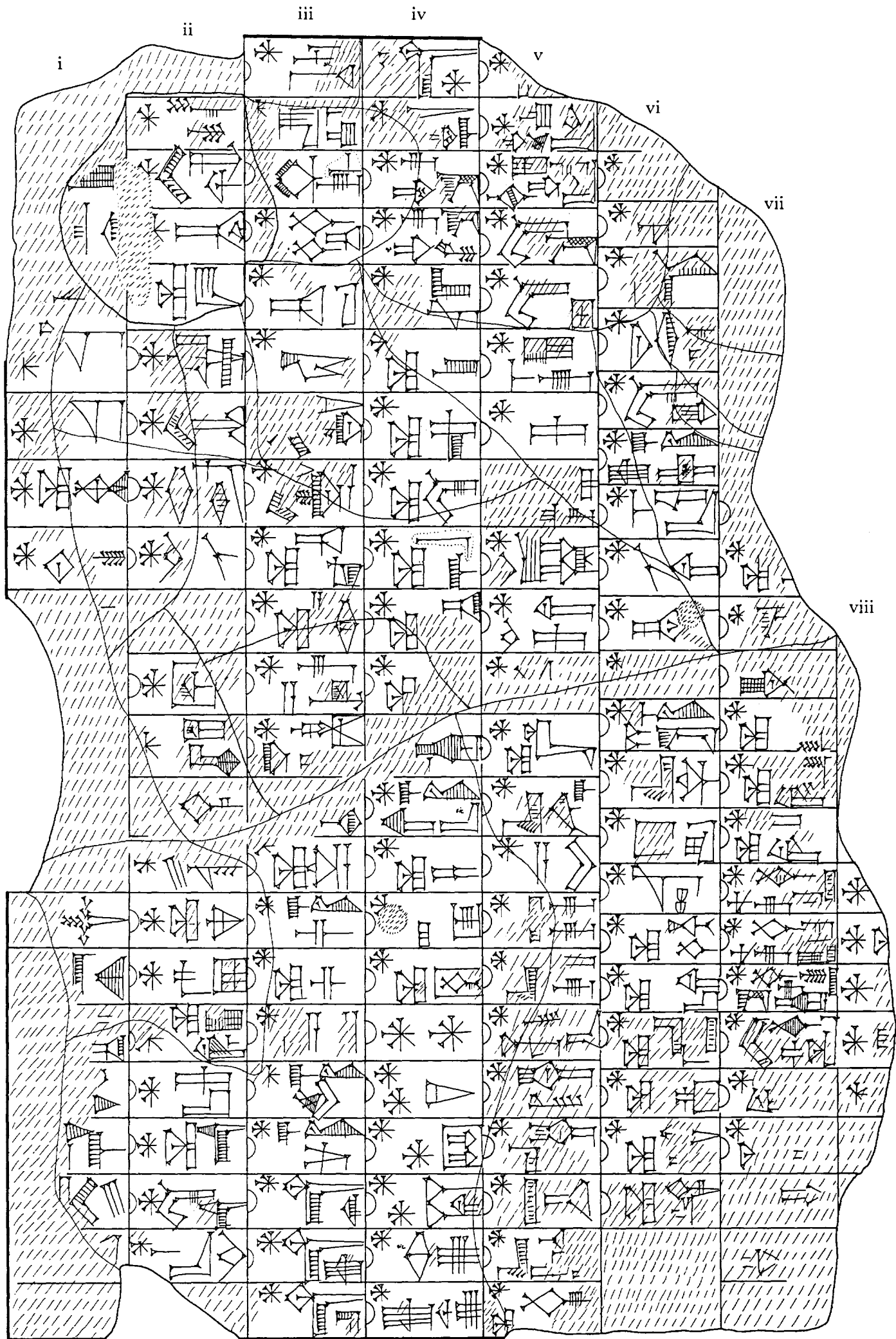

Obverse
No. 82



Reverse
No. 82

PLATE 45

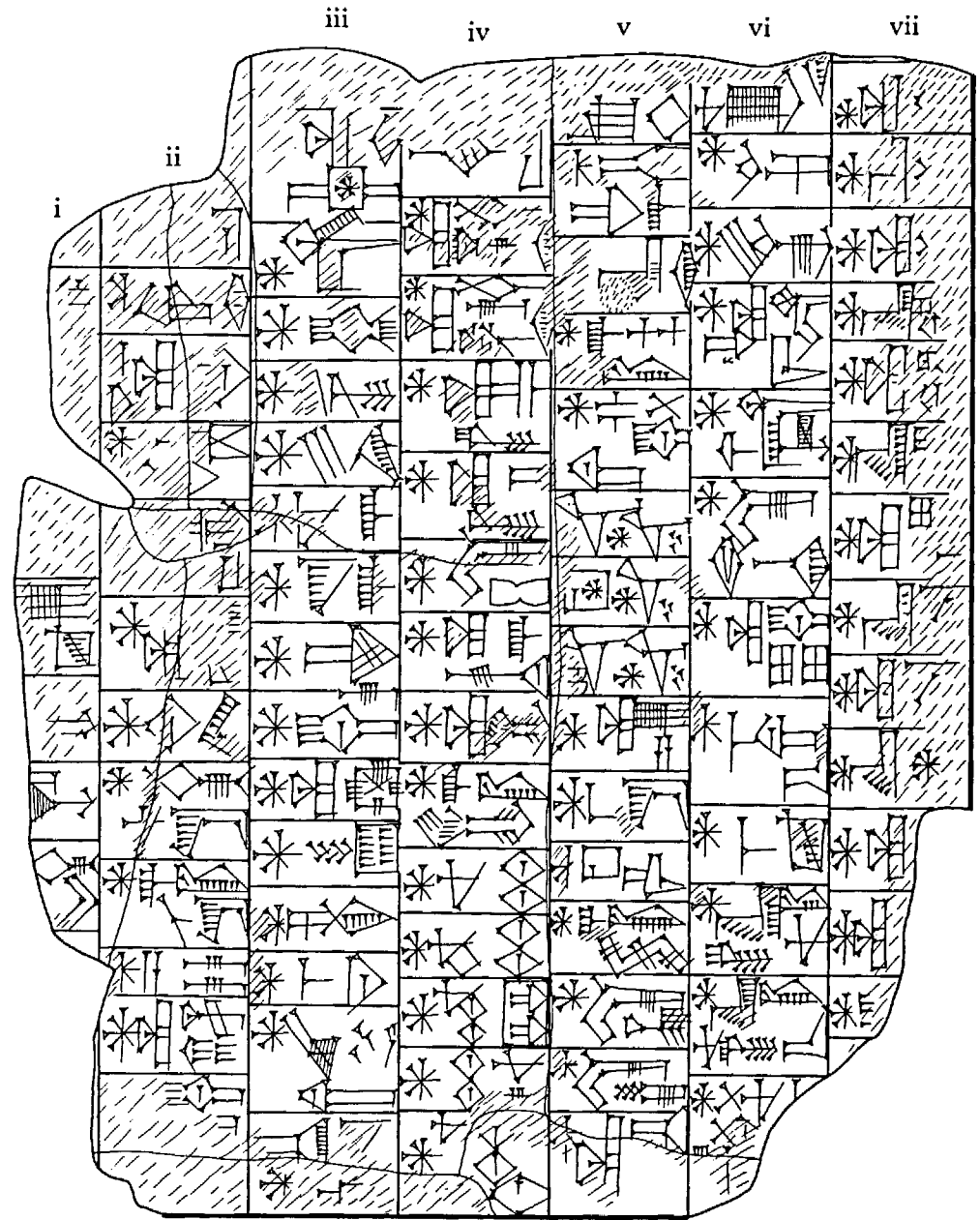

Obverse
No. 83

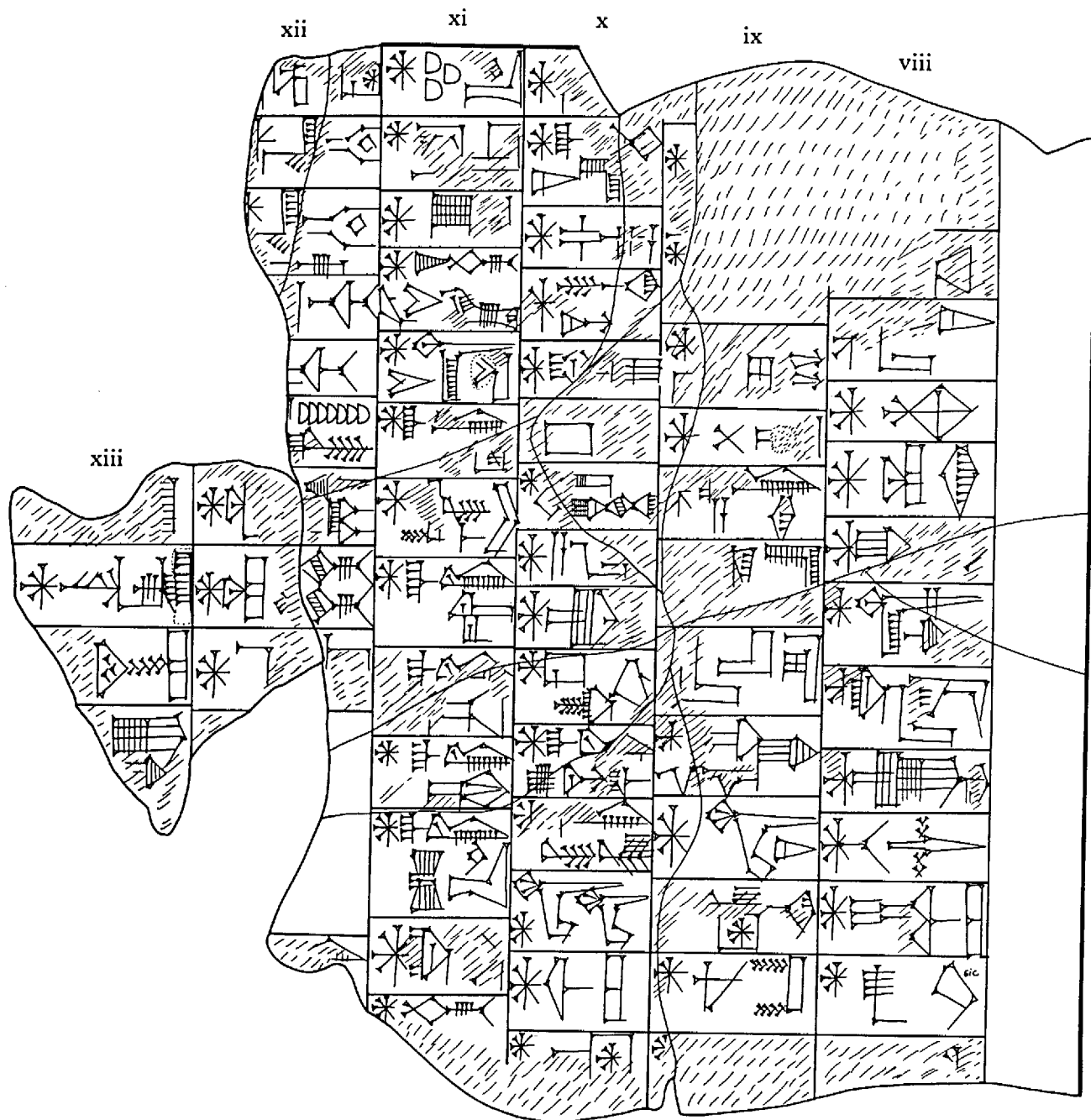

Reverse
No. 83

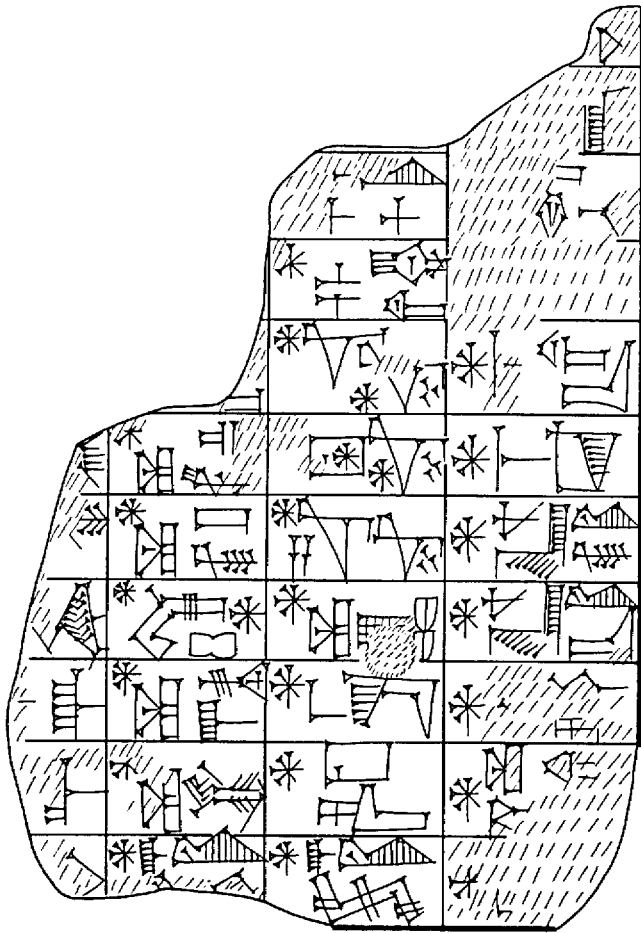

Obverse
No. 84

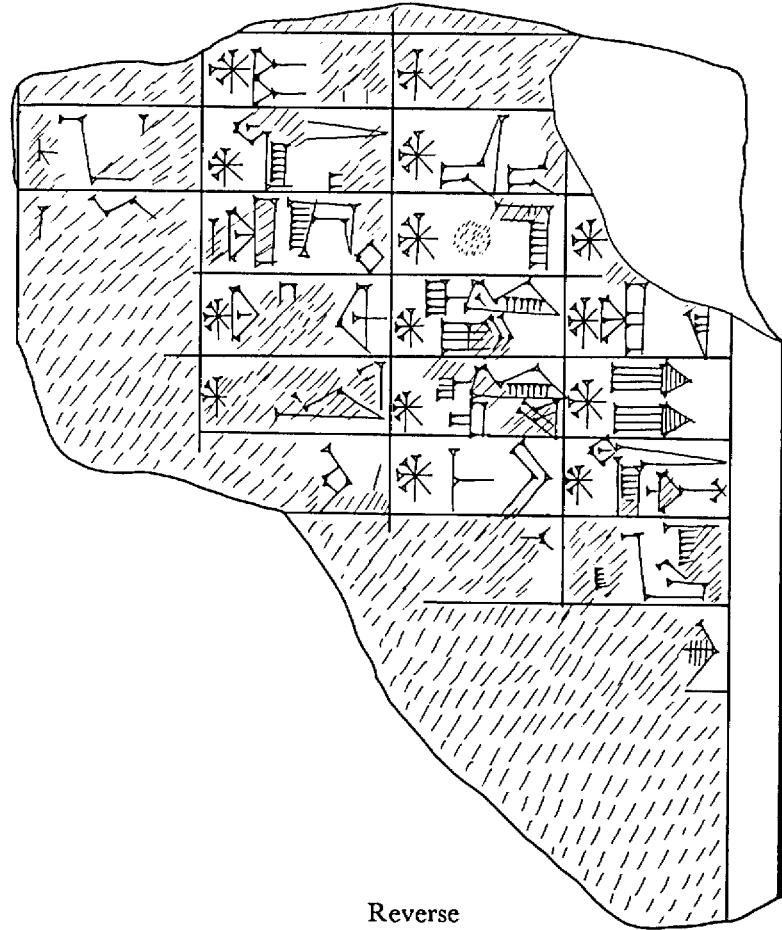

Reverse
No. 84

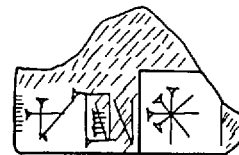

No. 85

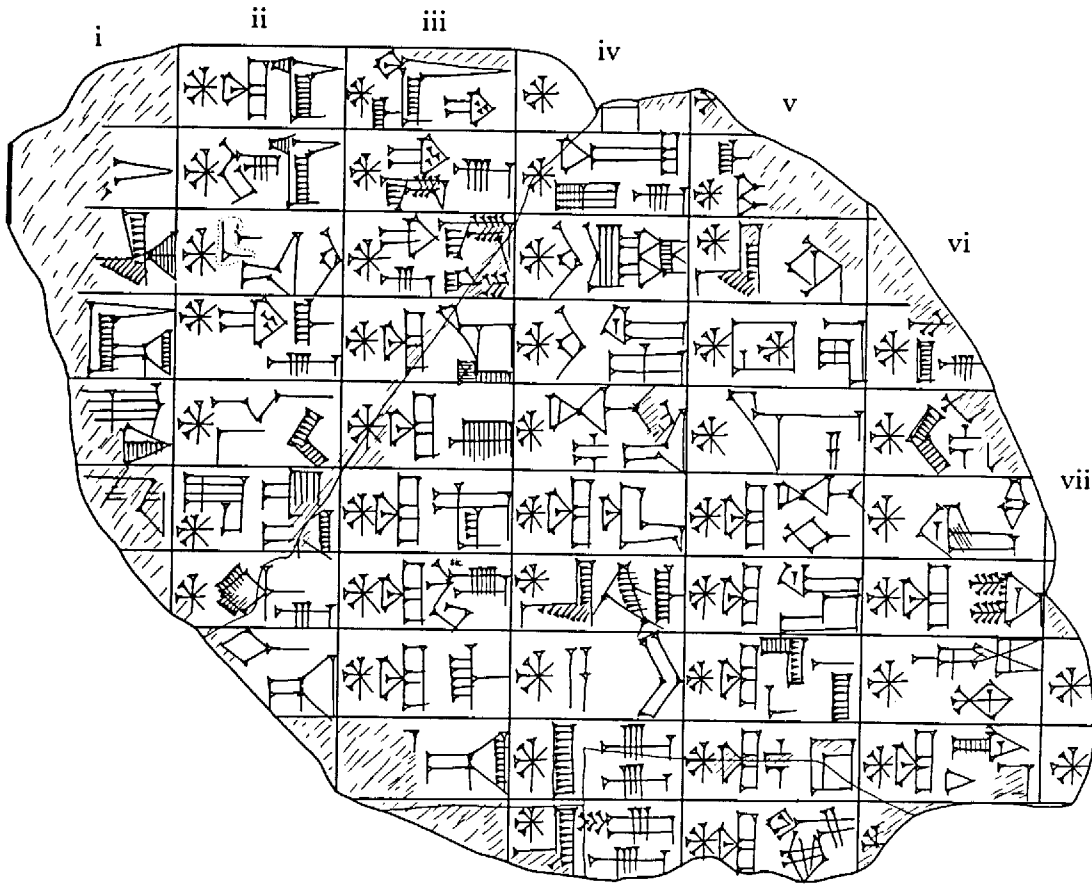

No. 86

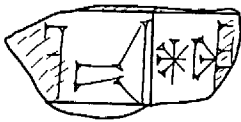

No. 87

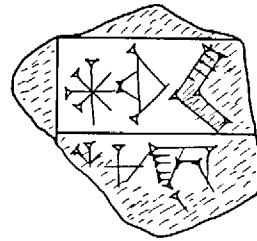

No. 88

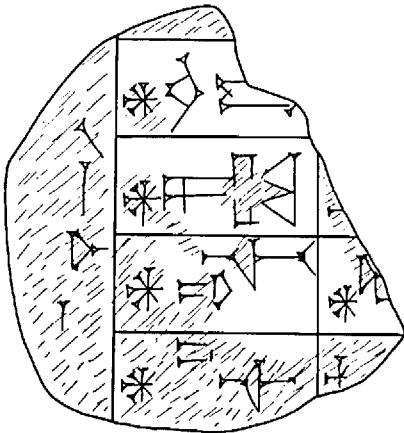

No. 89

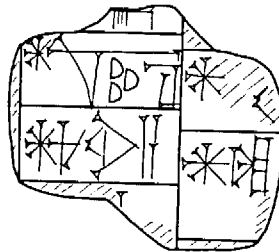

No. 90

PLATE 49

73-78 97-105 121-32 145-59 170-83 193-207 217-30 244-54

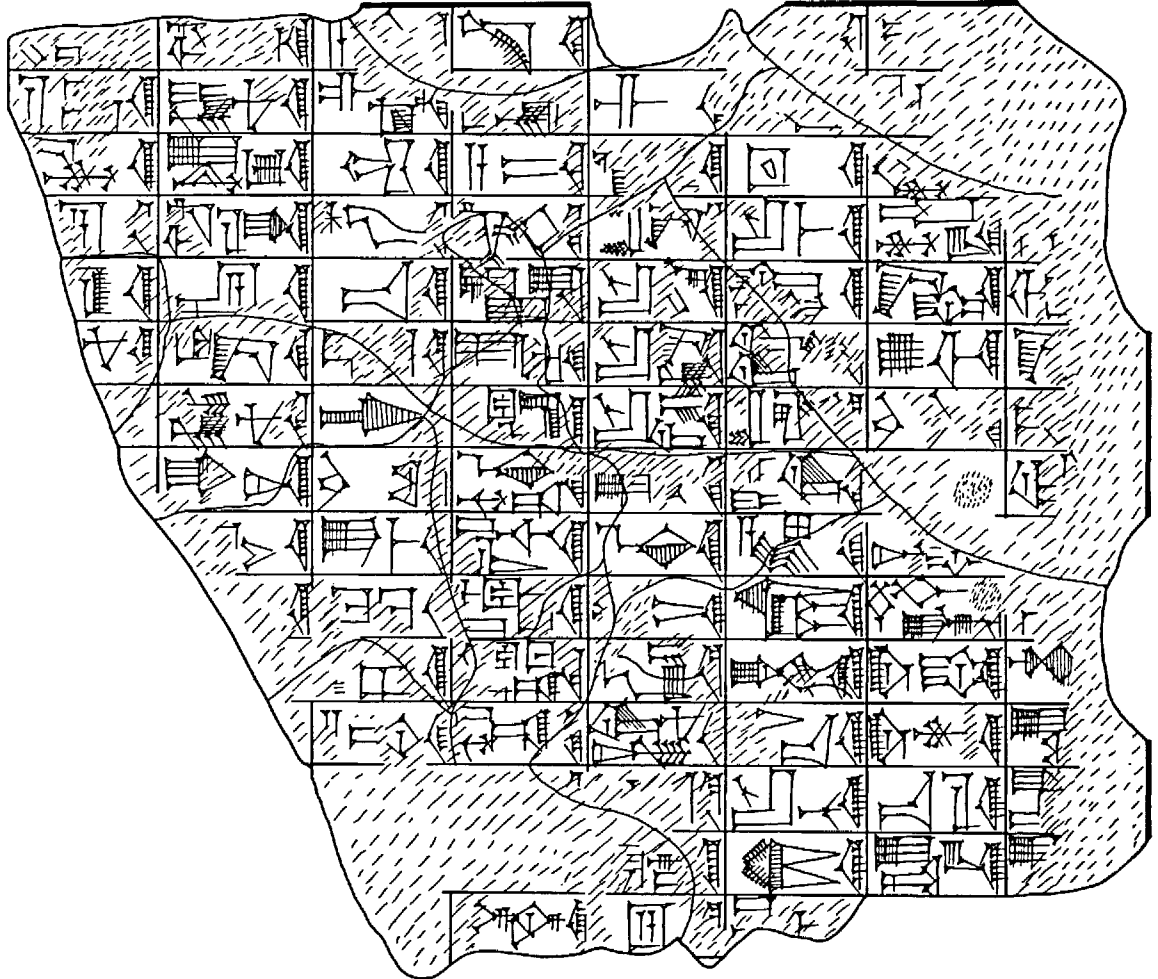

Obverse
No. 91

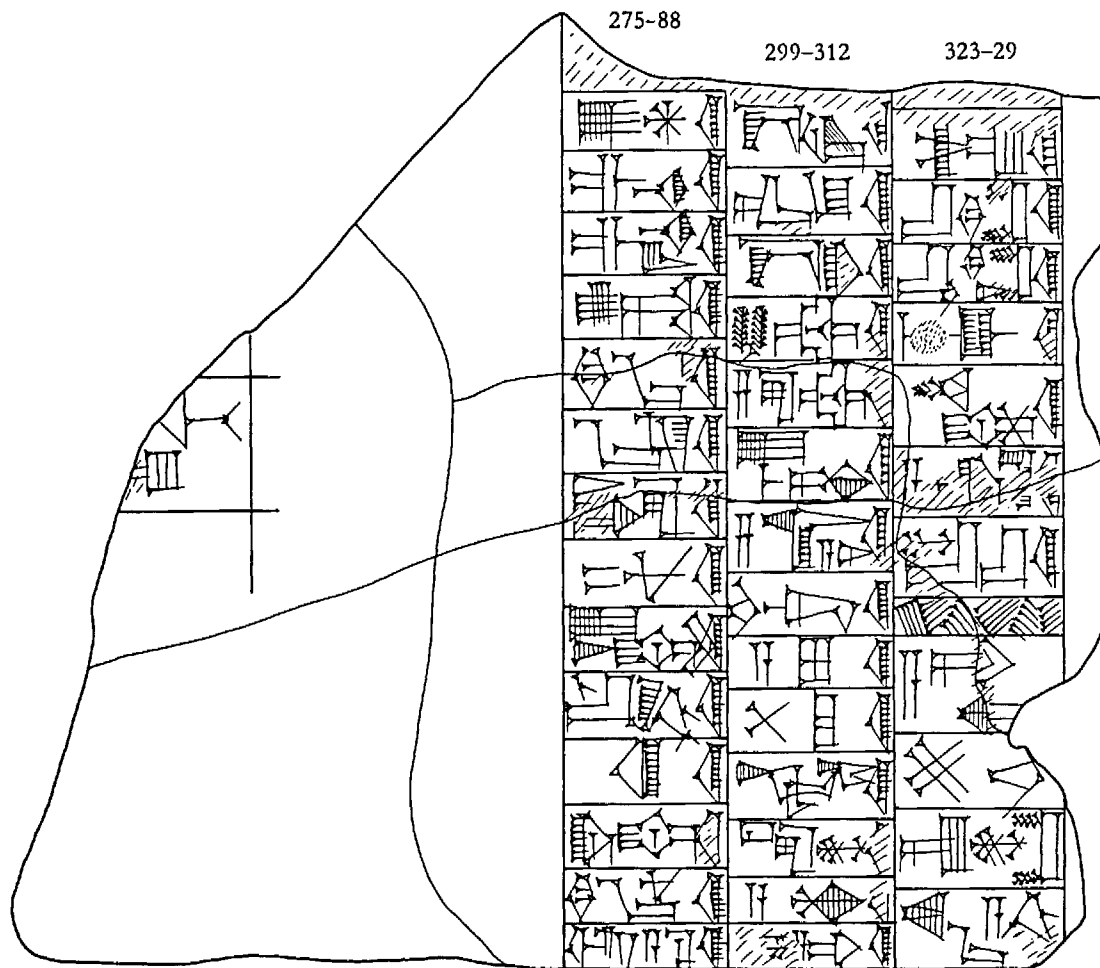

Reverse
No. 91

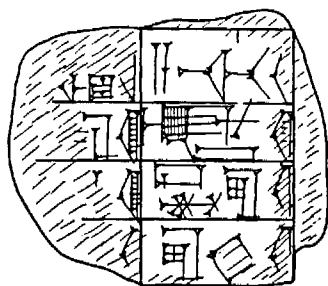

No. 92

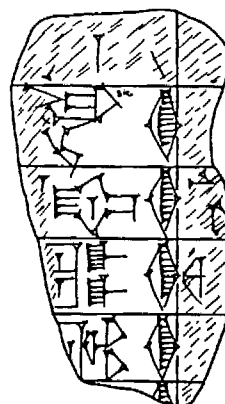

No. 93

PLATE 51

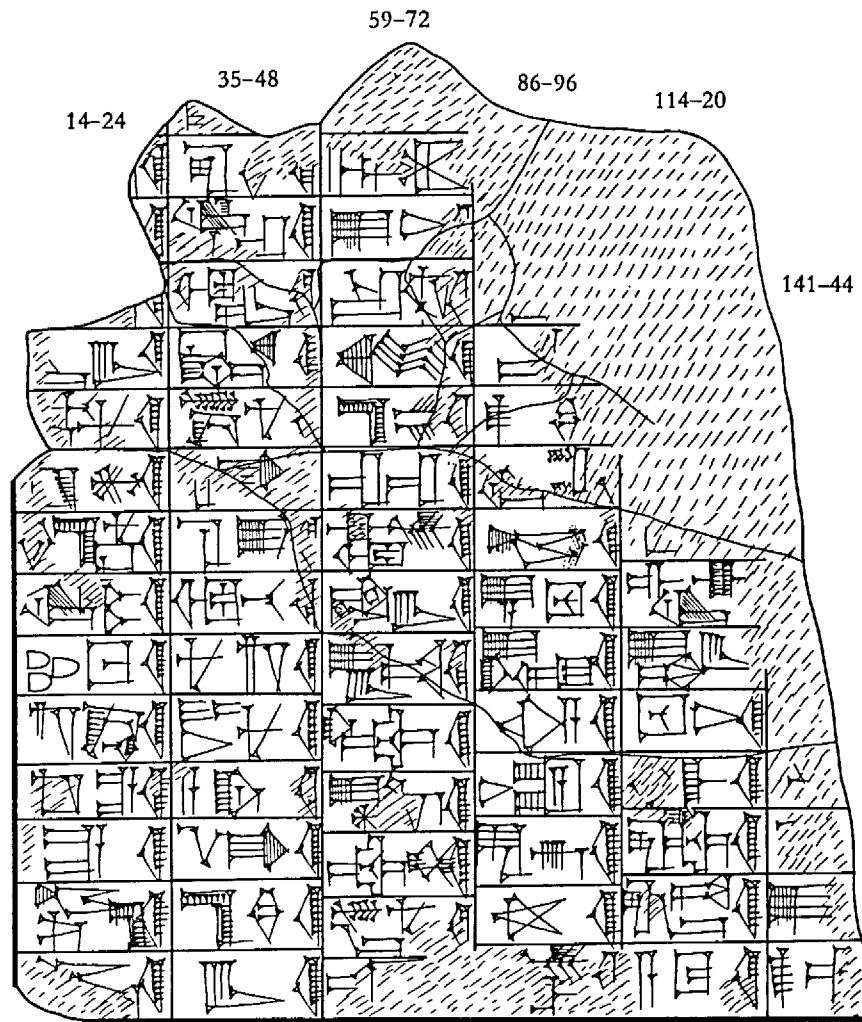

Obverse
No. 94

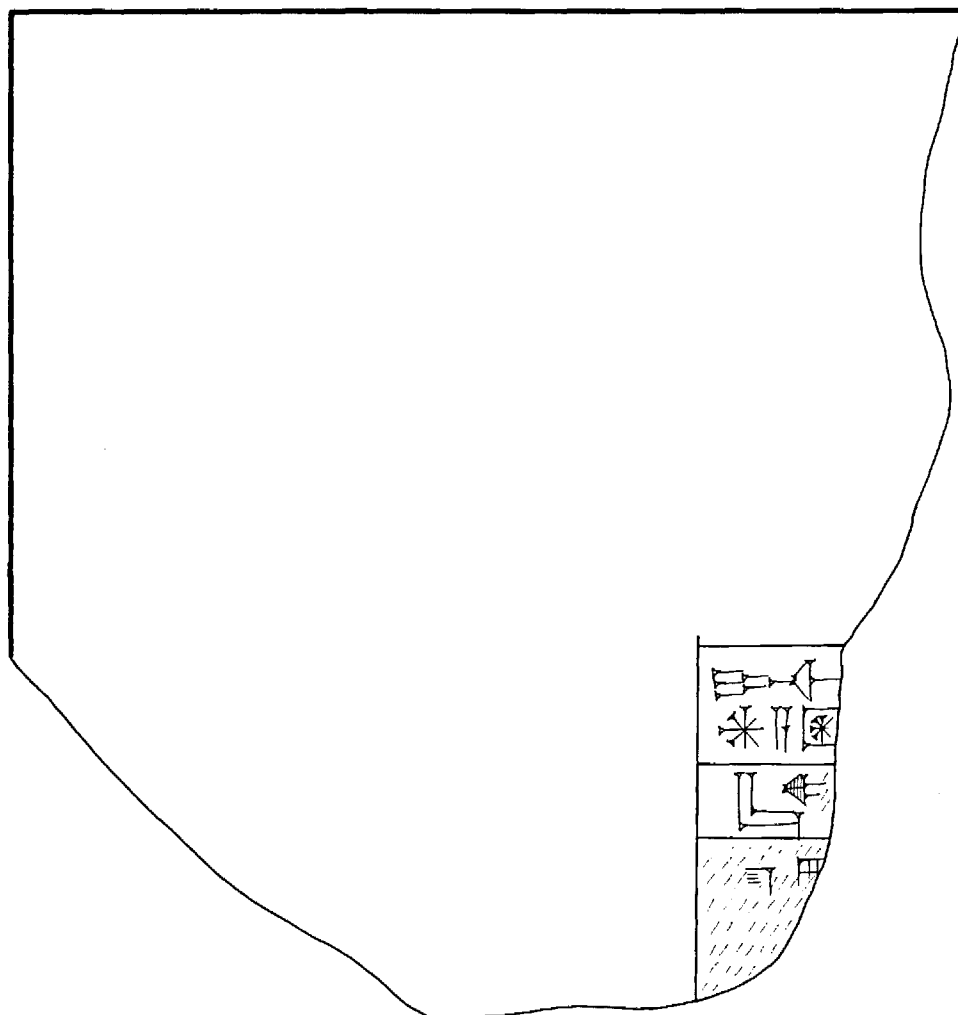

Reverse
No. 94

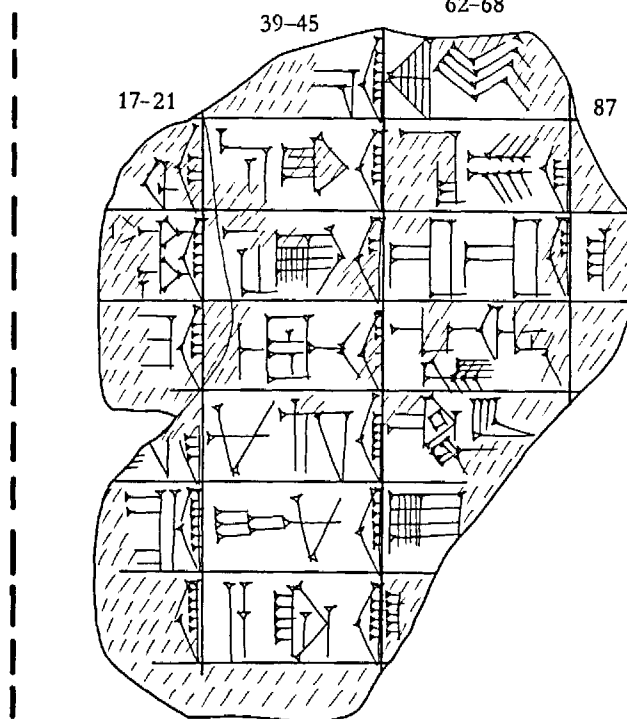

No. 95

PLATE 53

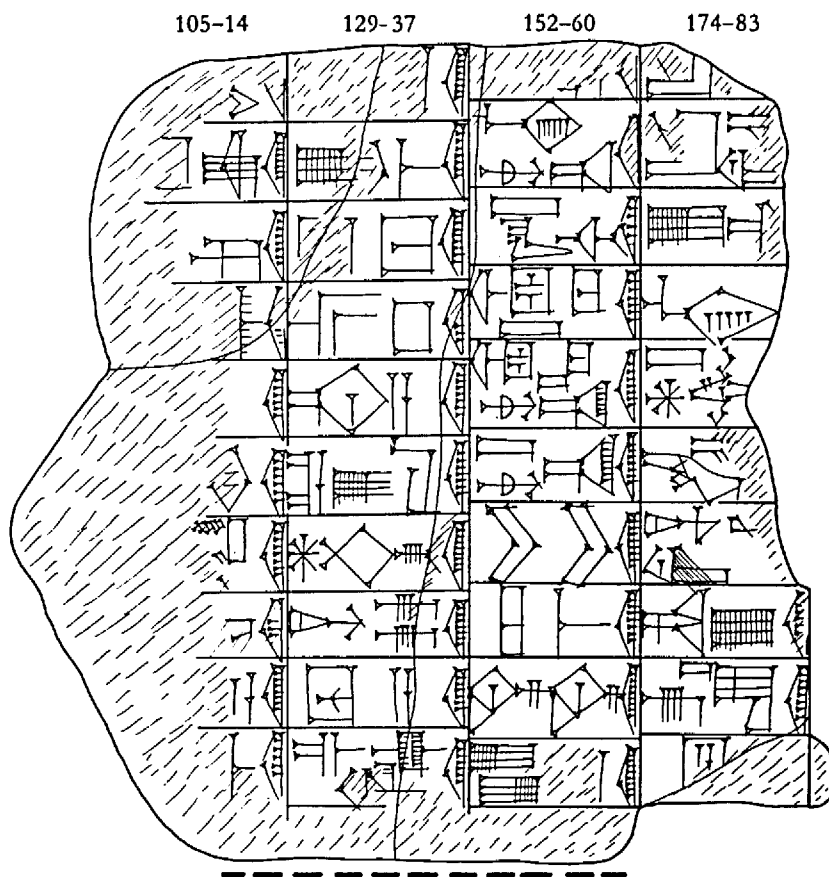

No. 96

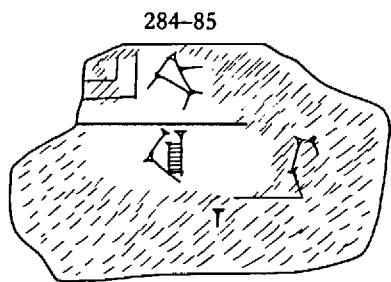

No. 97

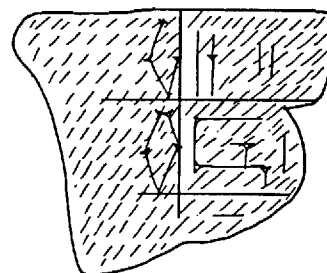

No. 98

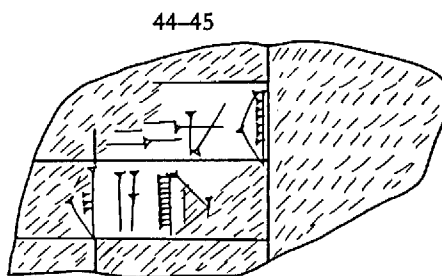

No. 99

38-41 64-66

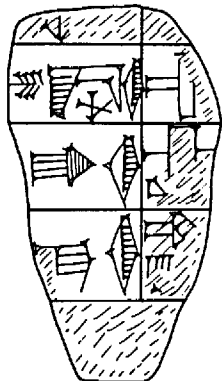

No. 100

126-28 152-53

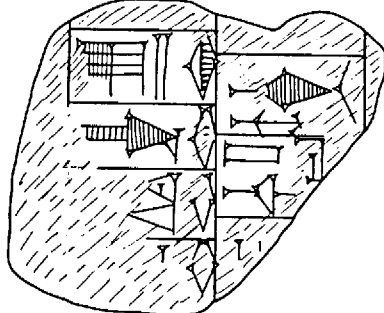

No. 101

218-20

242-43

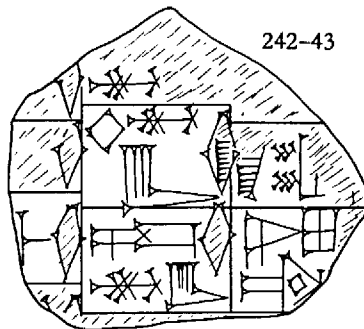

No. 102

284-88

222-26

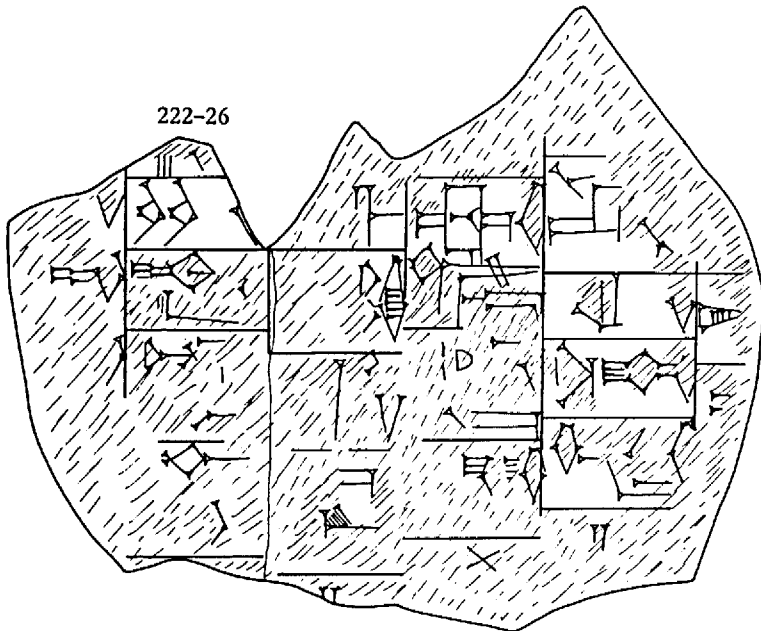

No. 103

252

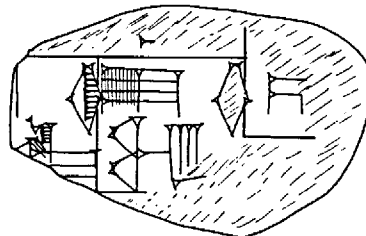

No. 104

327-29

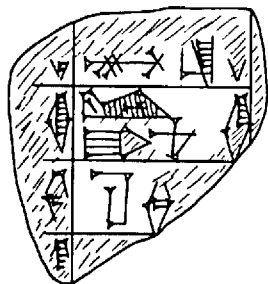

No. 105

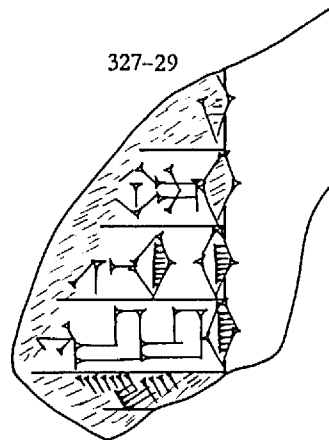

No. 106

PLATE 55

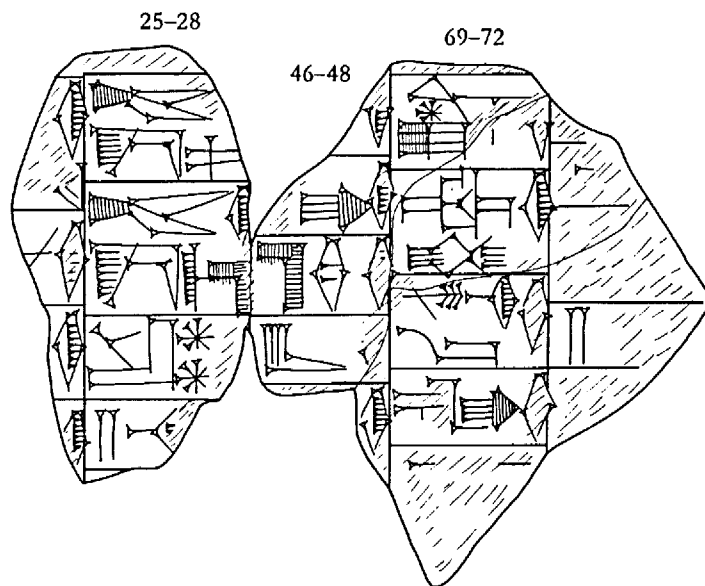

No. 107

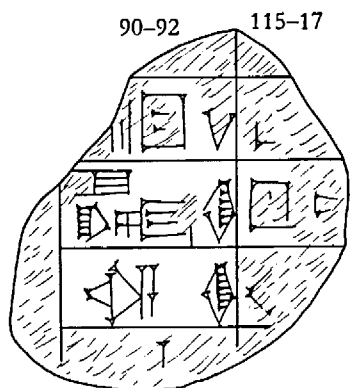

No. 108

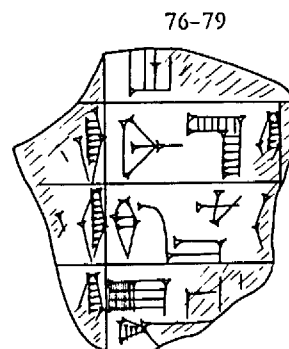

No. 109

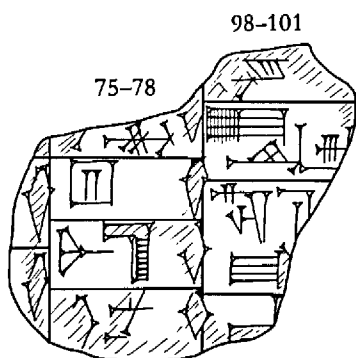

No. 110

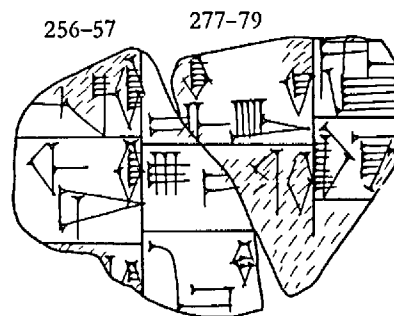

No. 111



Obverse
No. 112



Reverse
No. 112

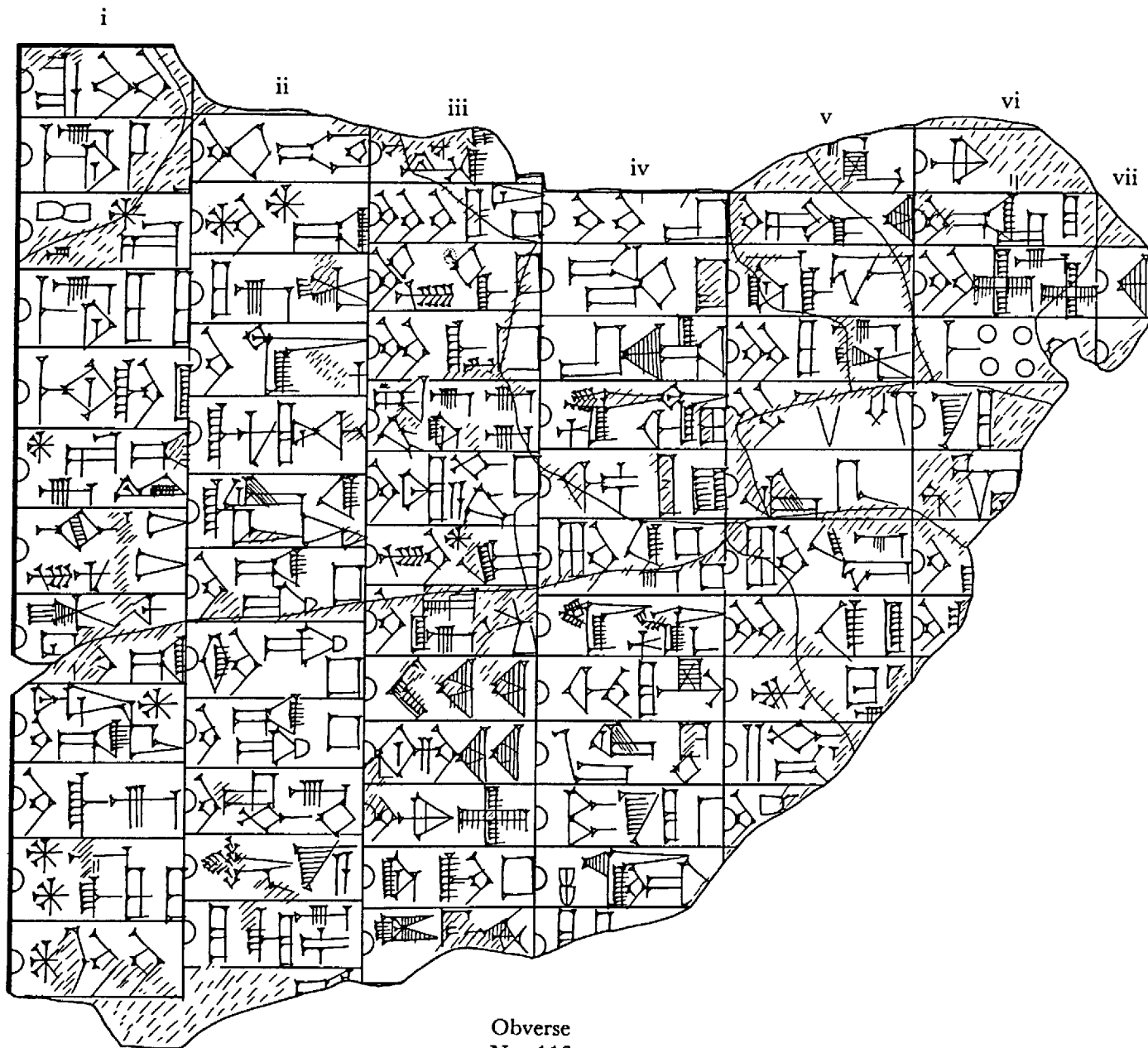

Obverse
No. 113

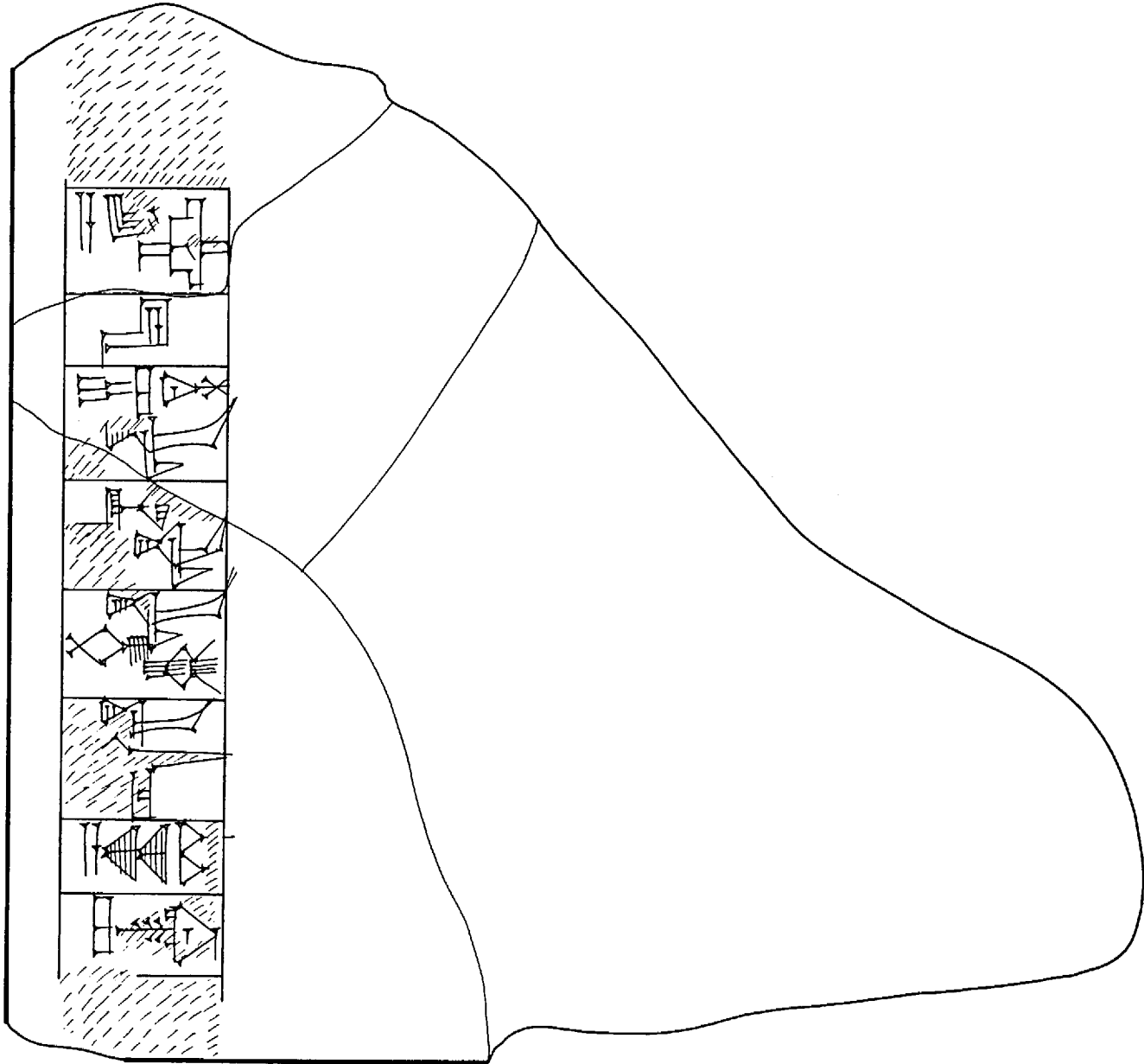

Reverse
No. 113

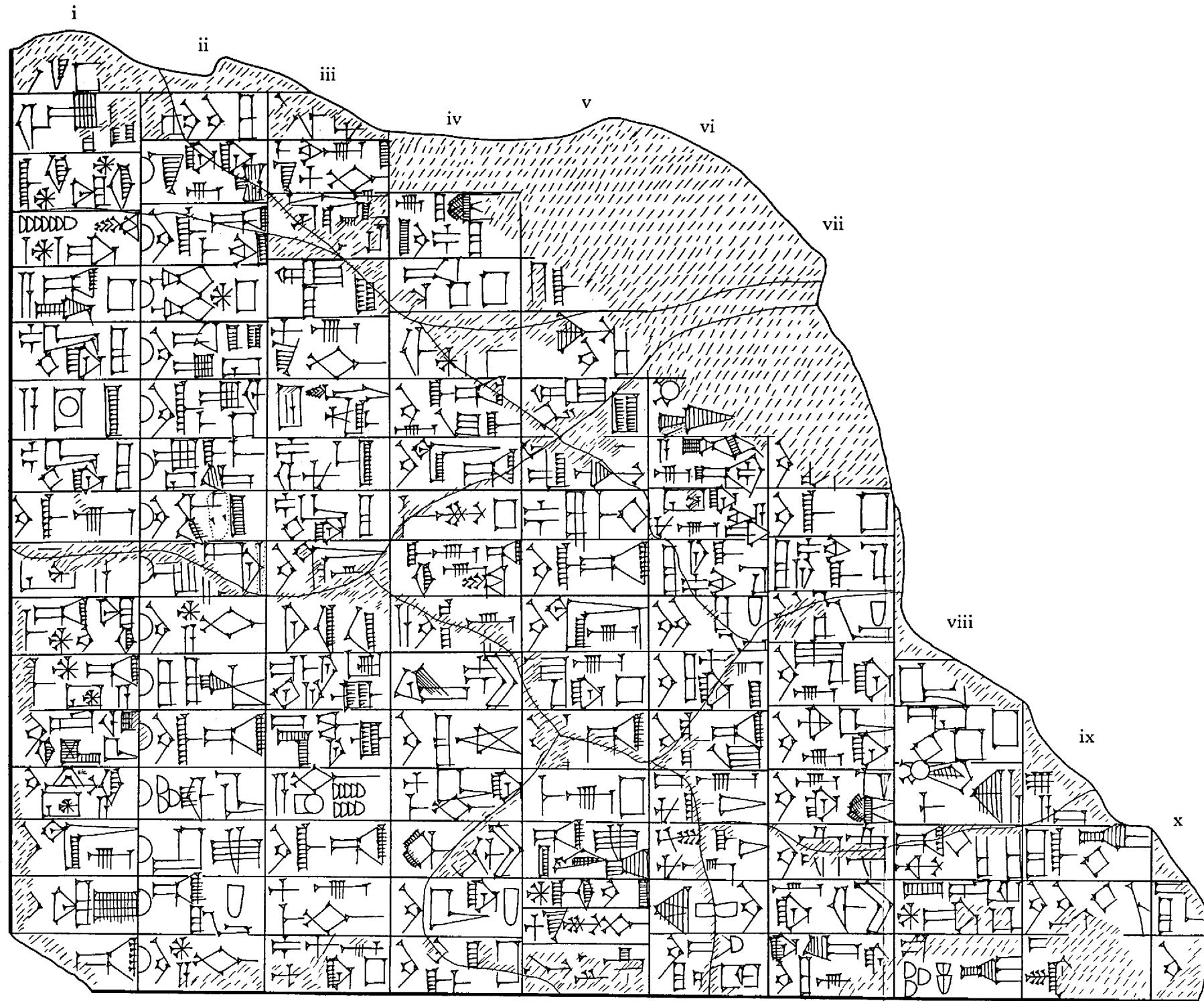

No. 114

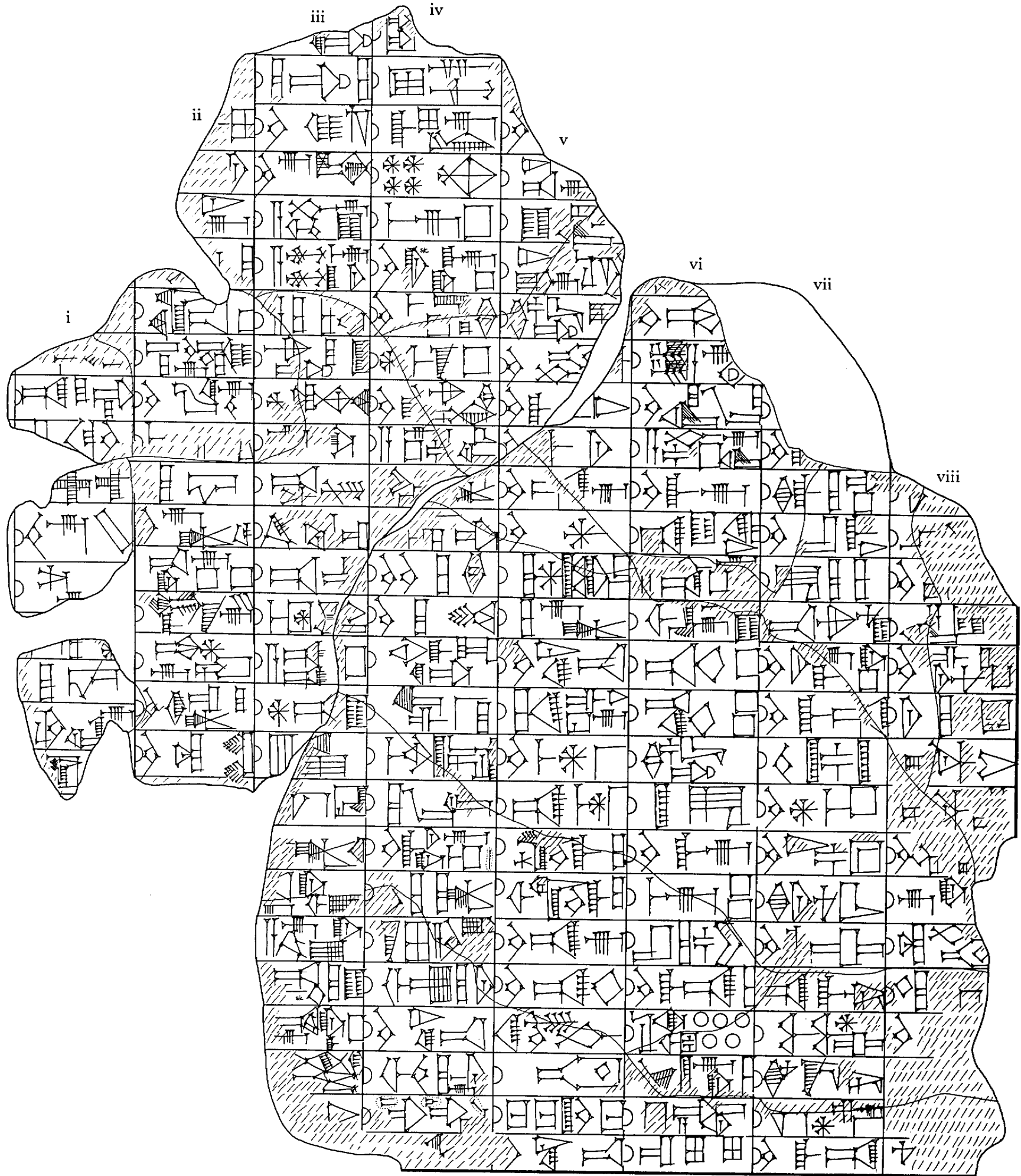

Obverse
No. 115

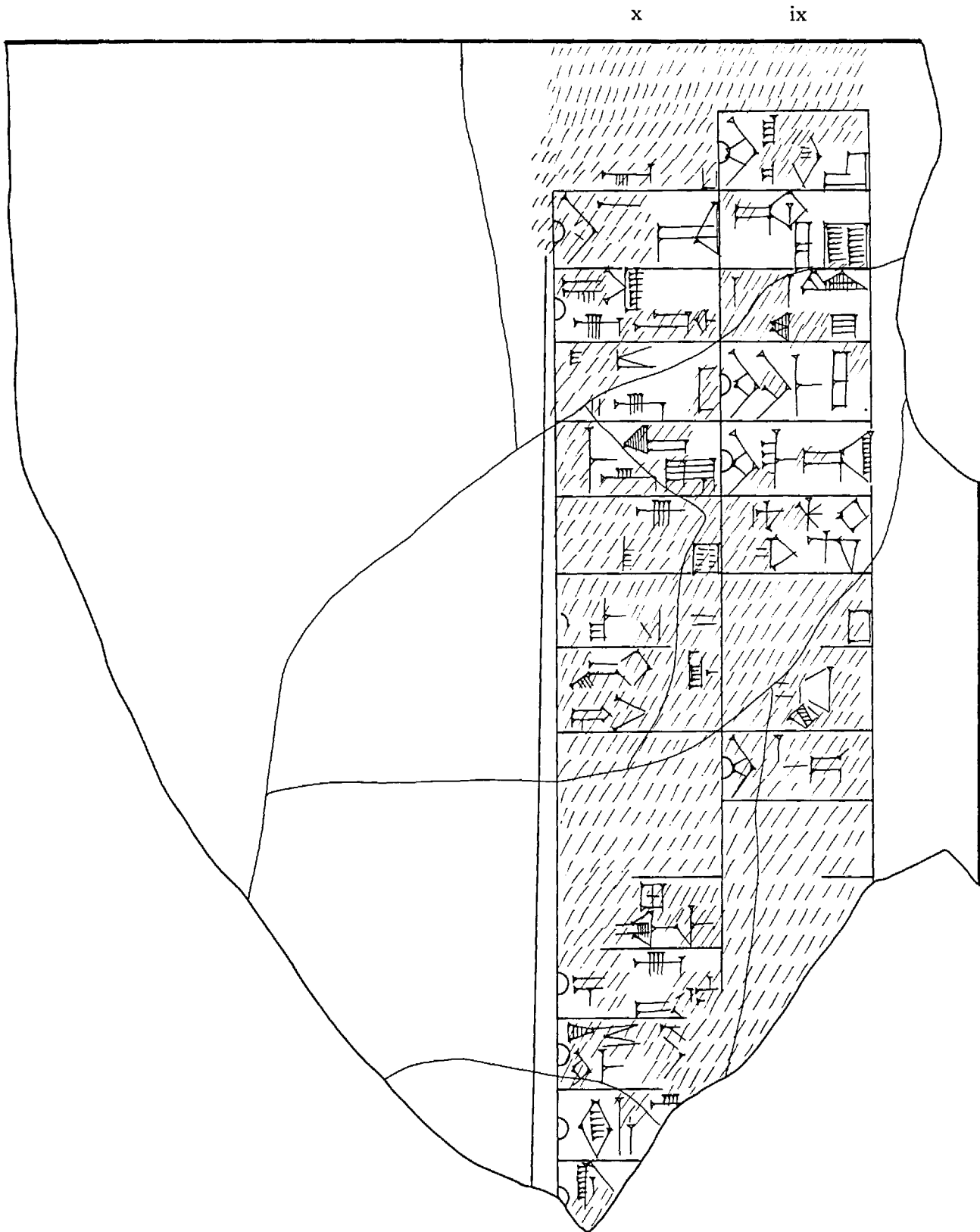

Reverse
No. 115

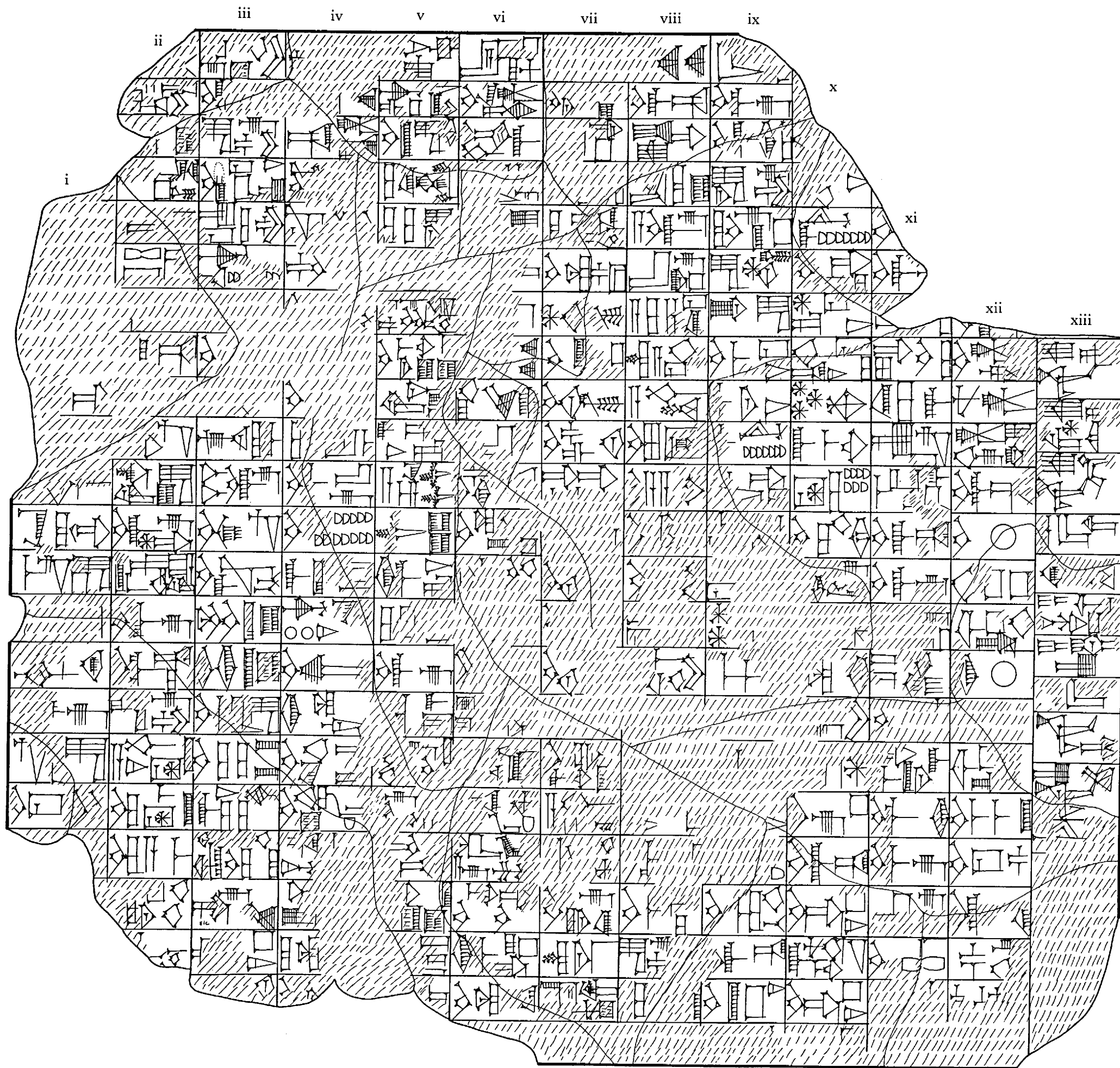

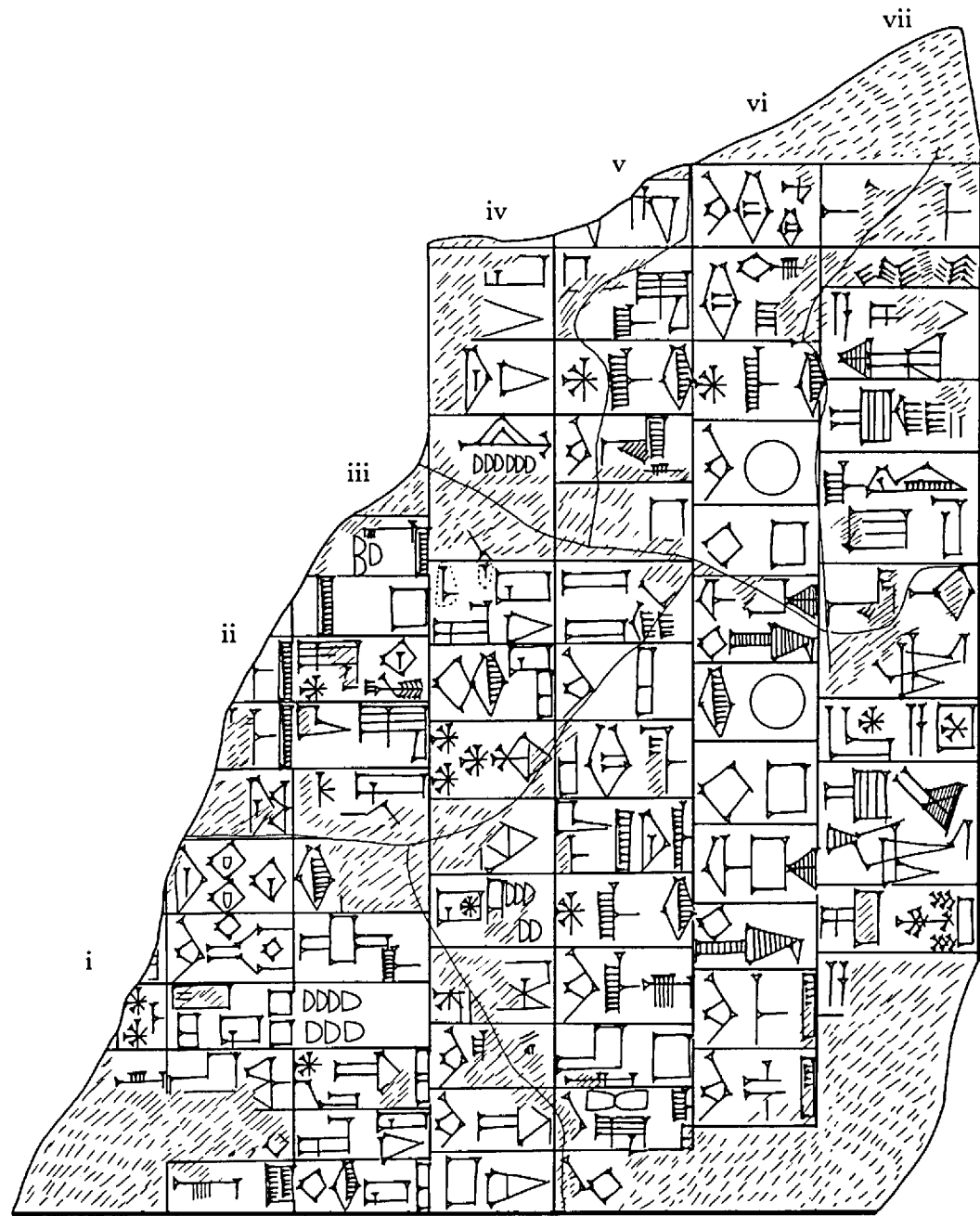

No. 117

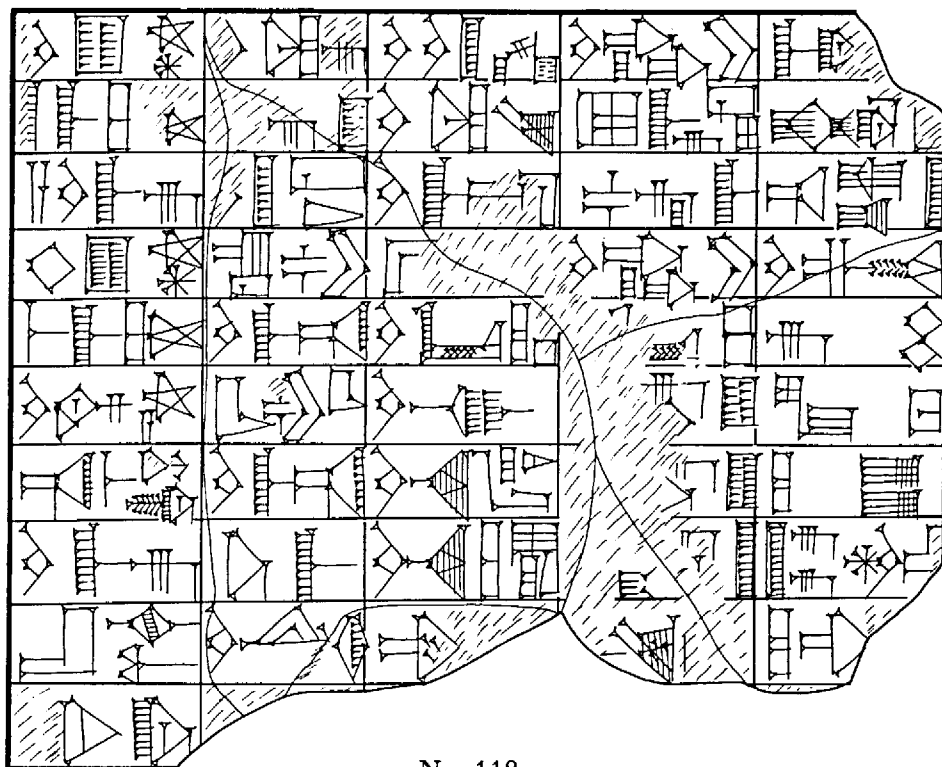

No. 118

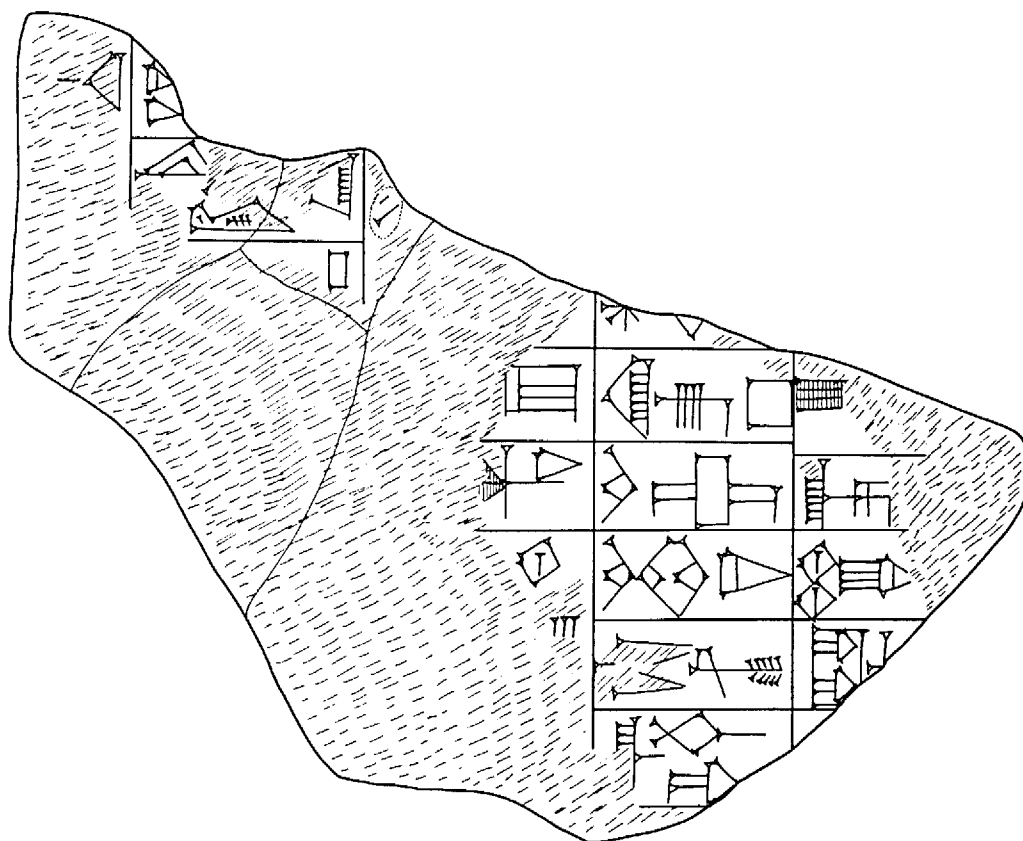

No. 119

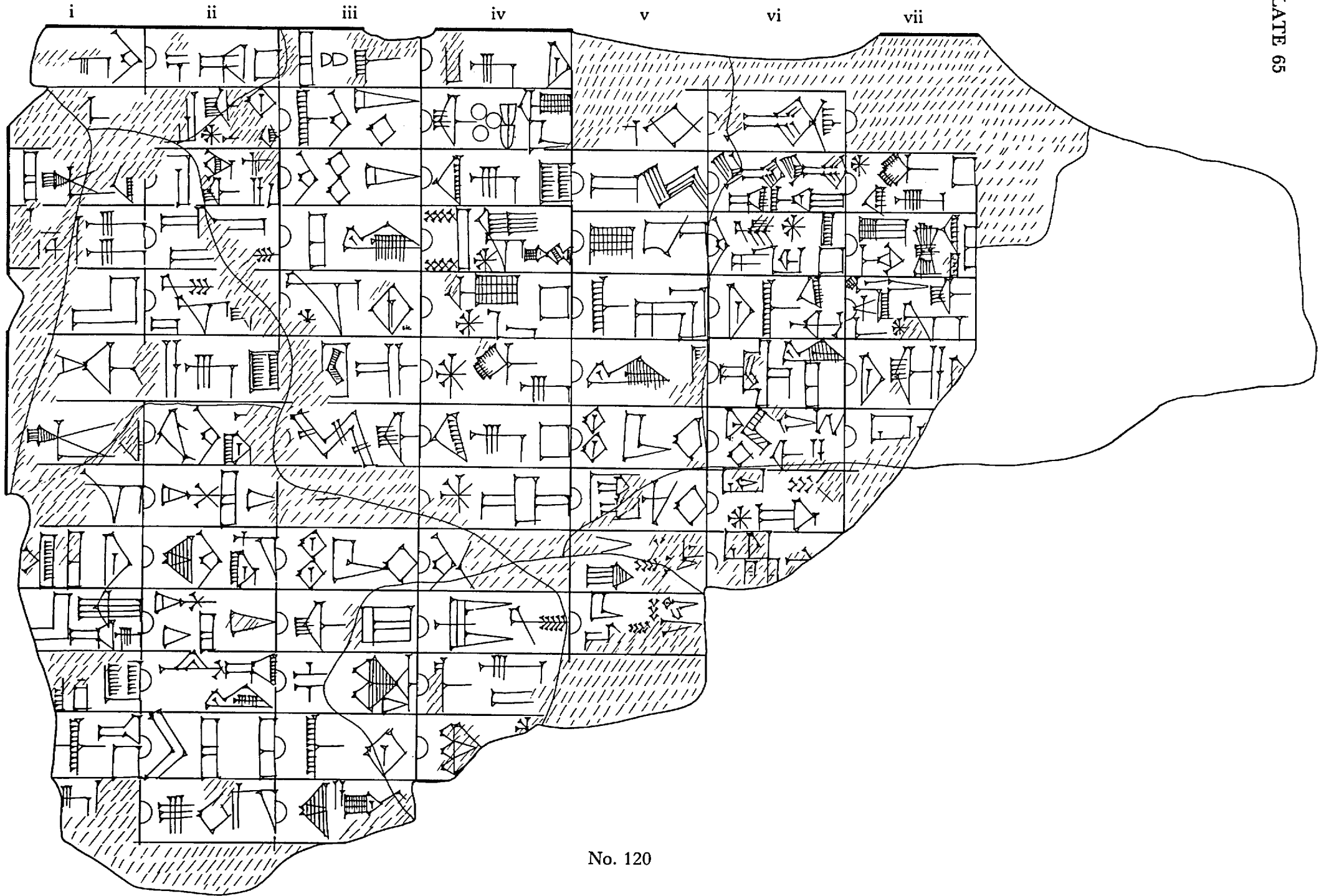

No. 120

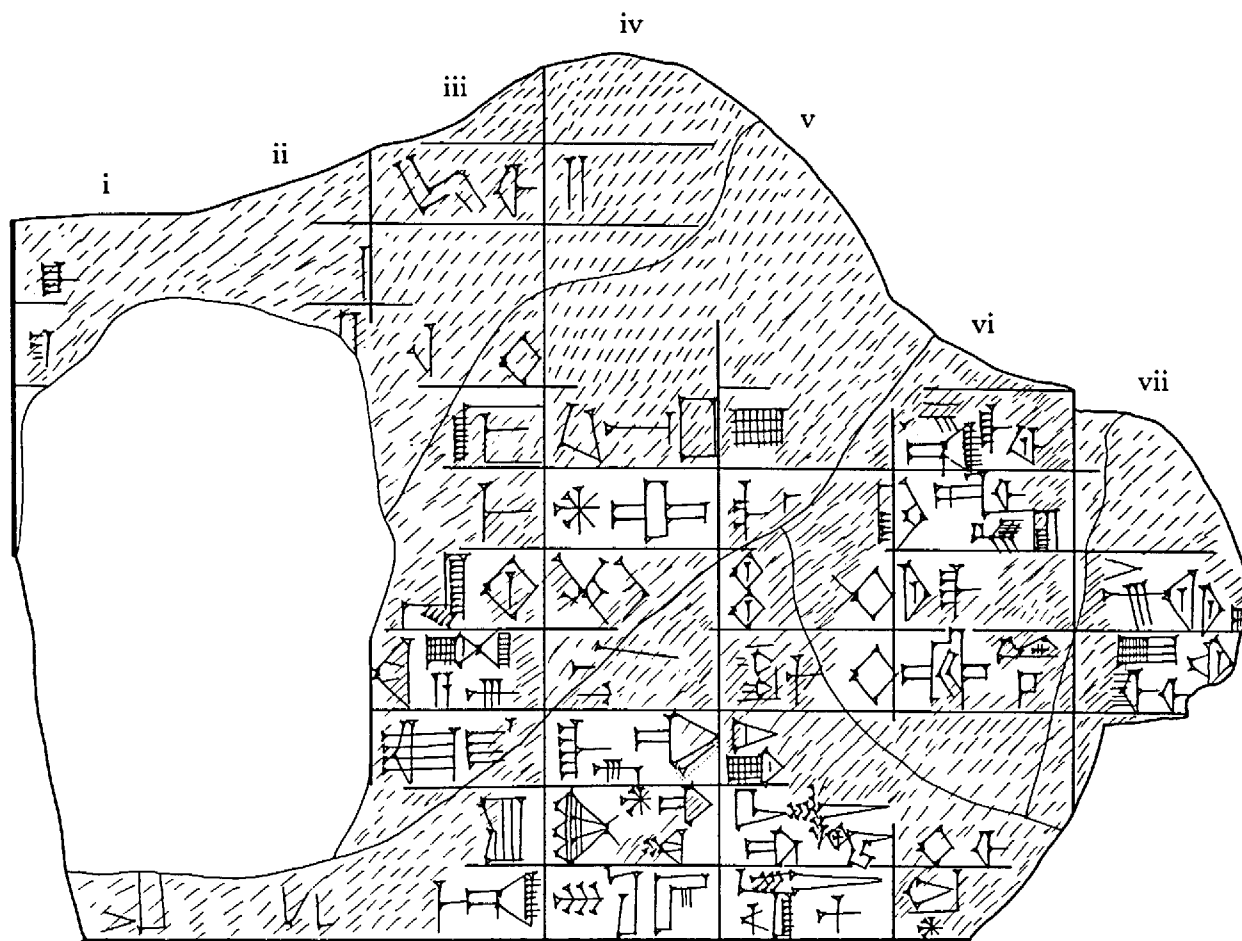

No. 121

PLATE 67

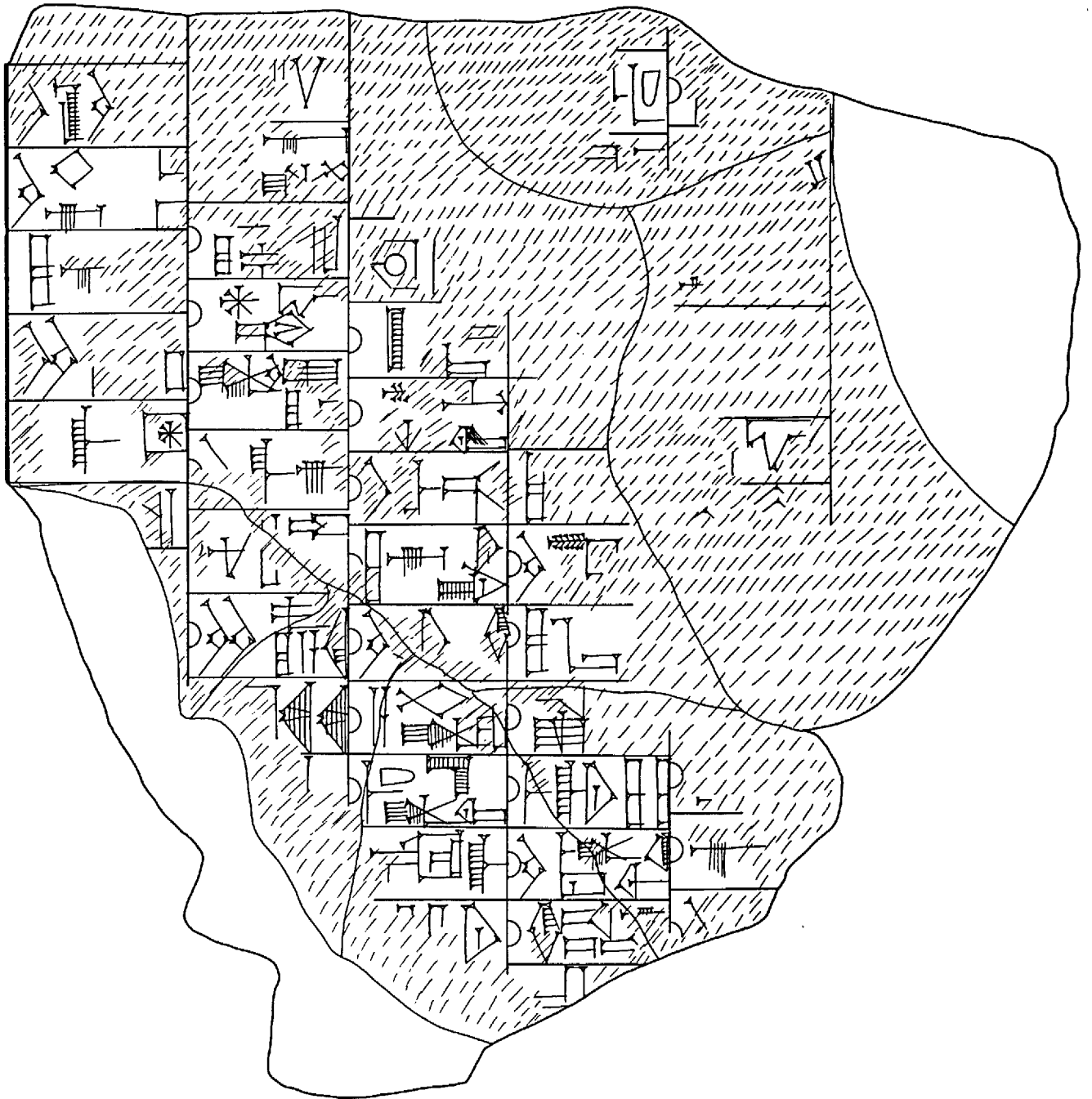

Obverse
No. 122

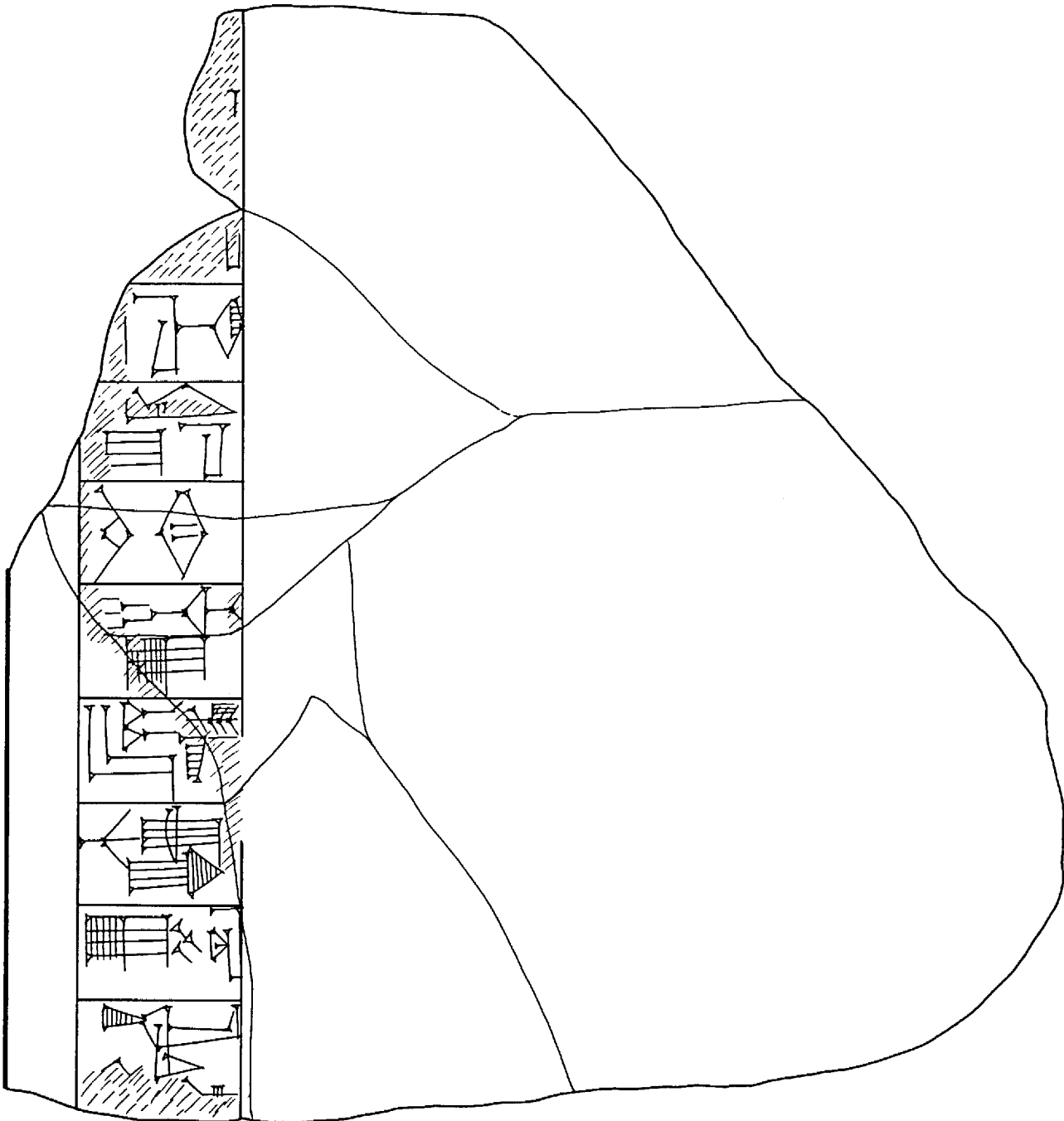

Reverse
No. 122

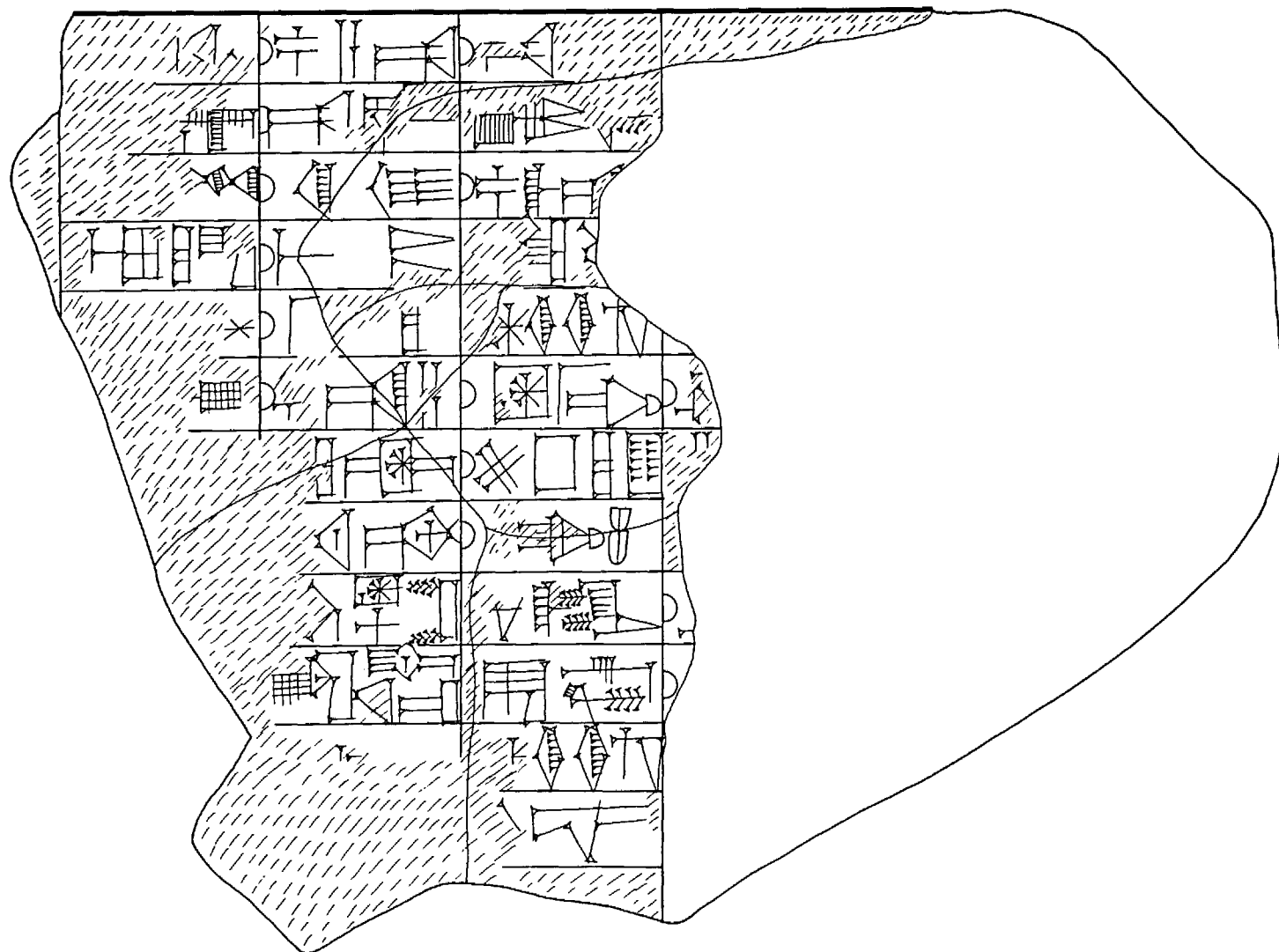

Obverse
No. 123

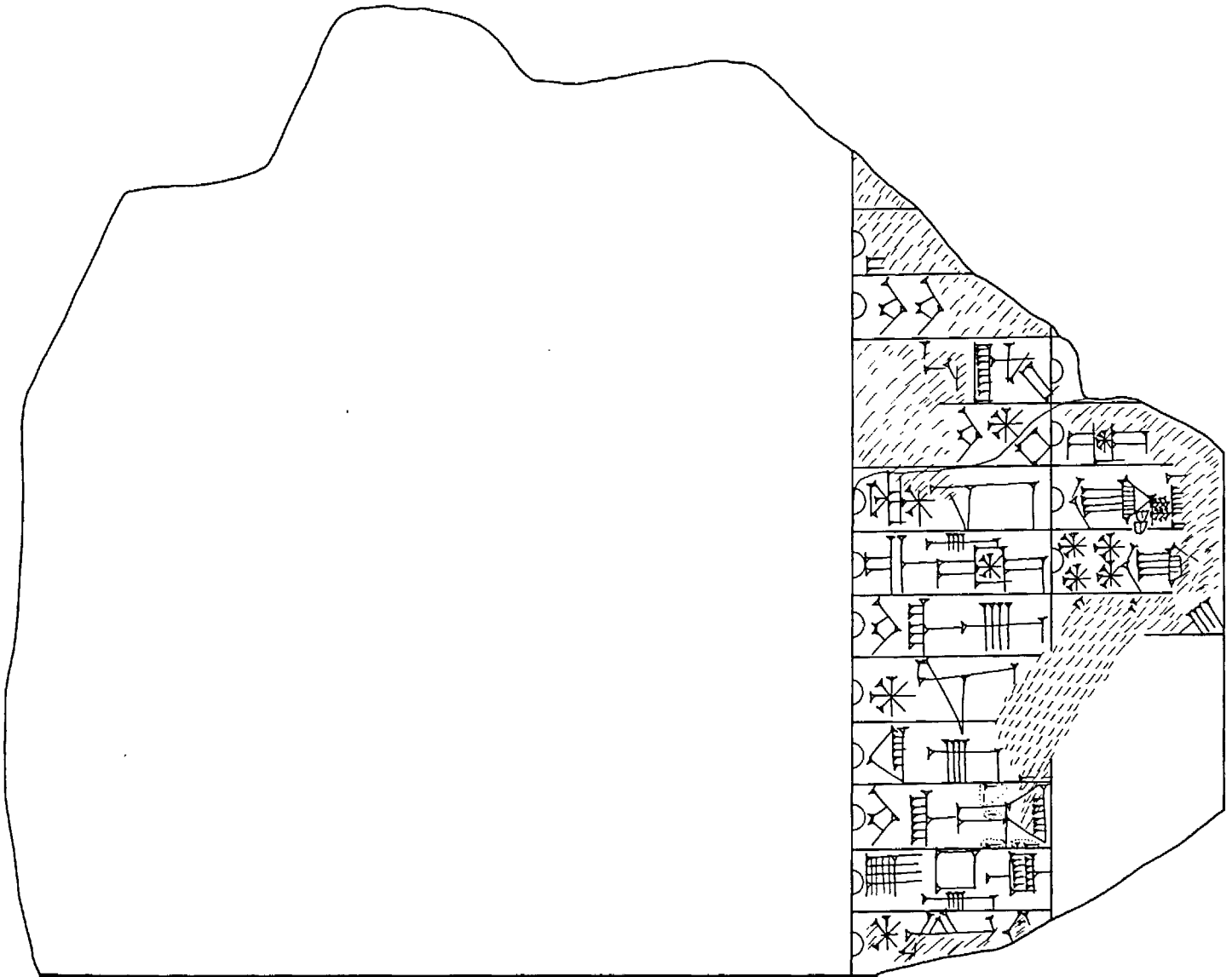

Reverse
No. 123

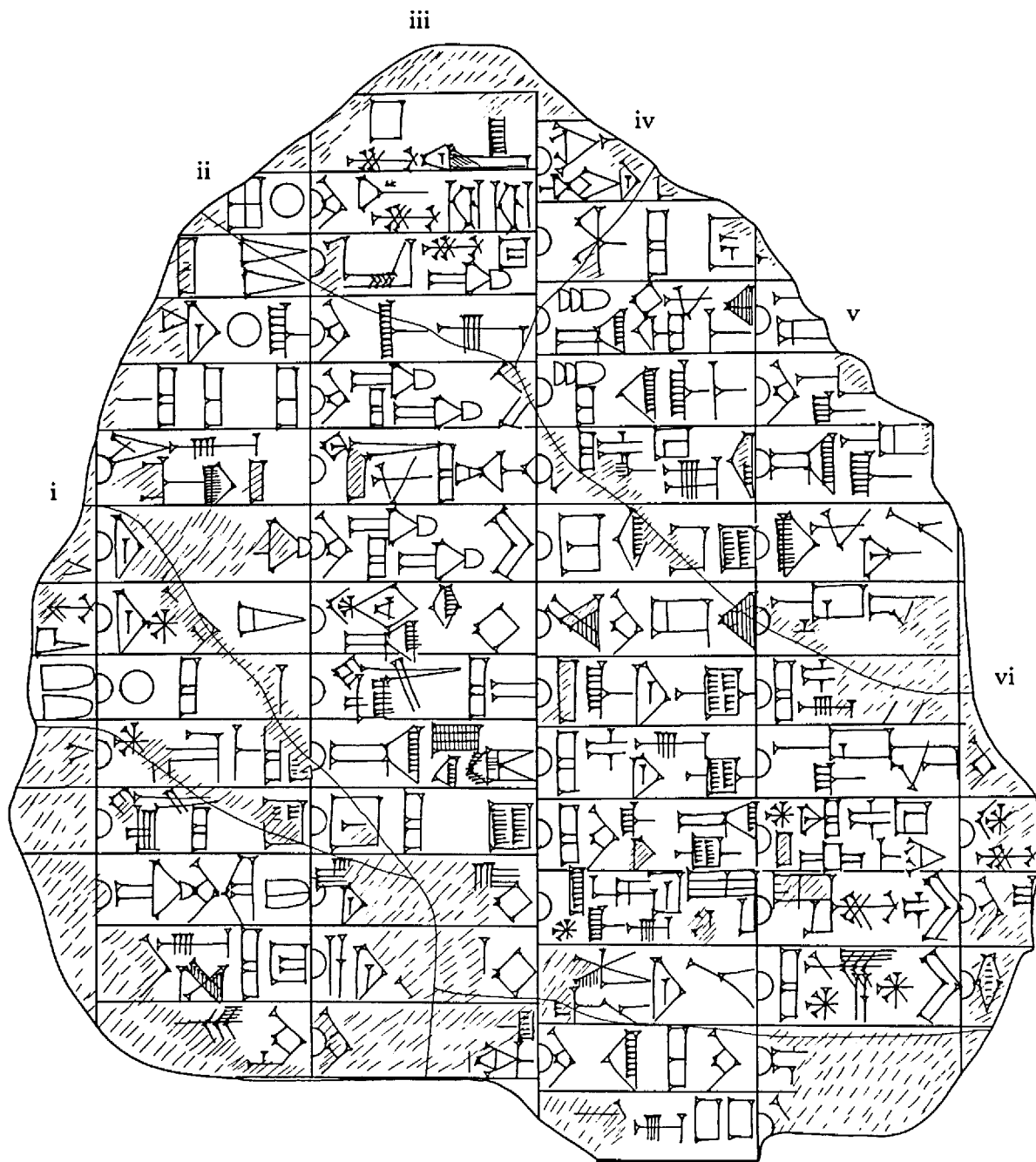

Obverse
No. 124

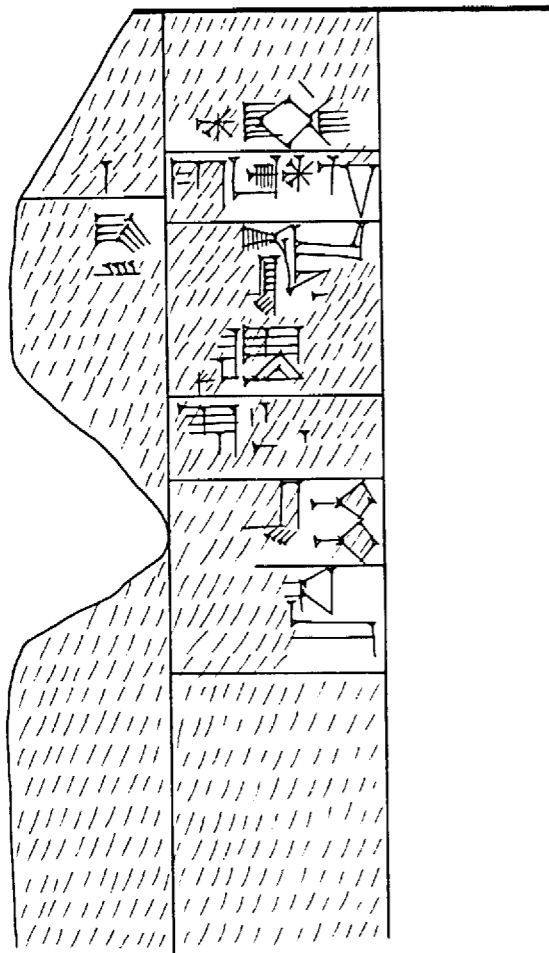

Reverse
No. 124

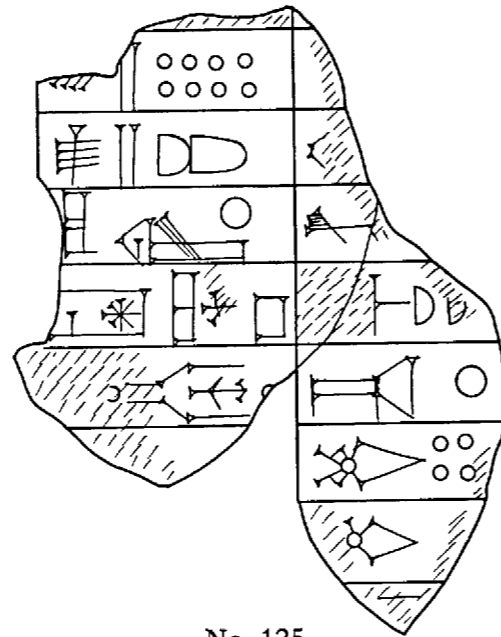

No. 125

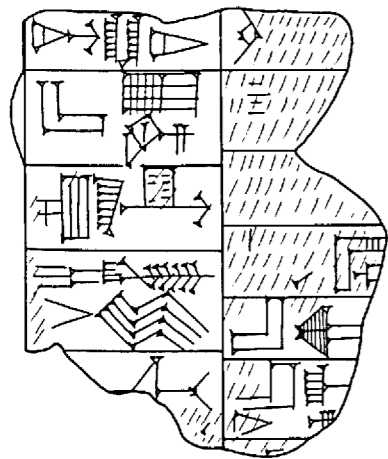

No. 126

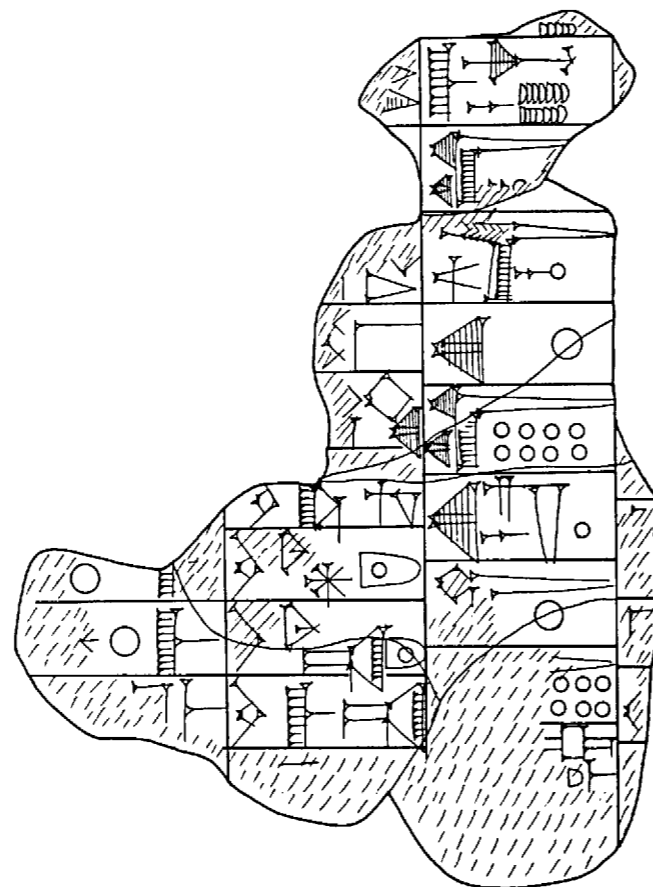

No. 127

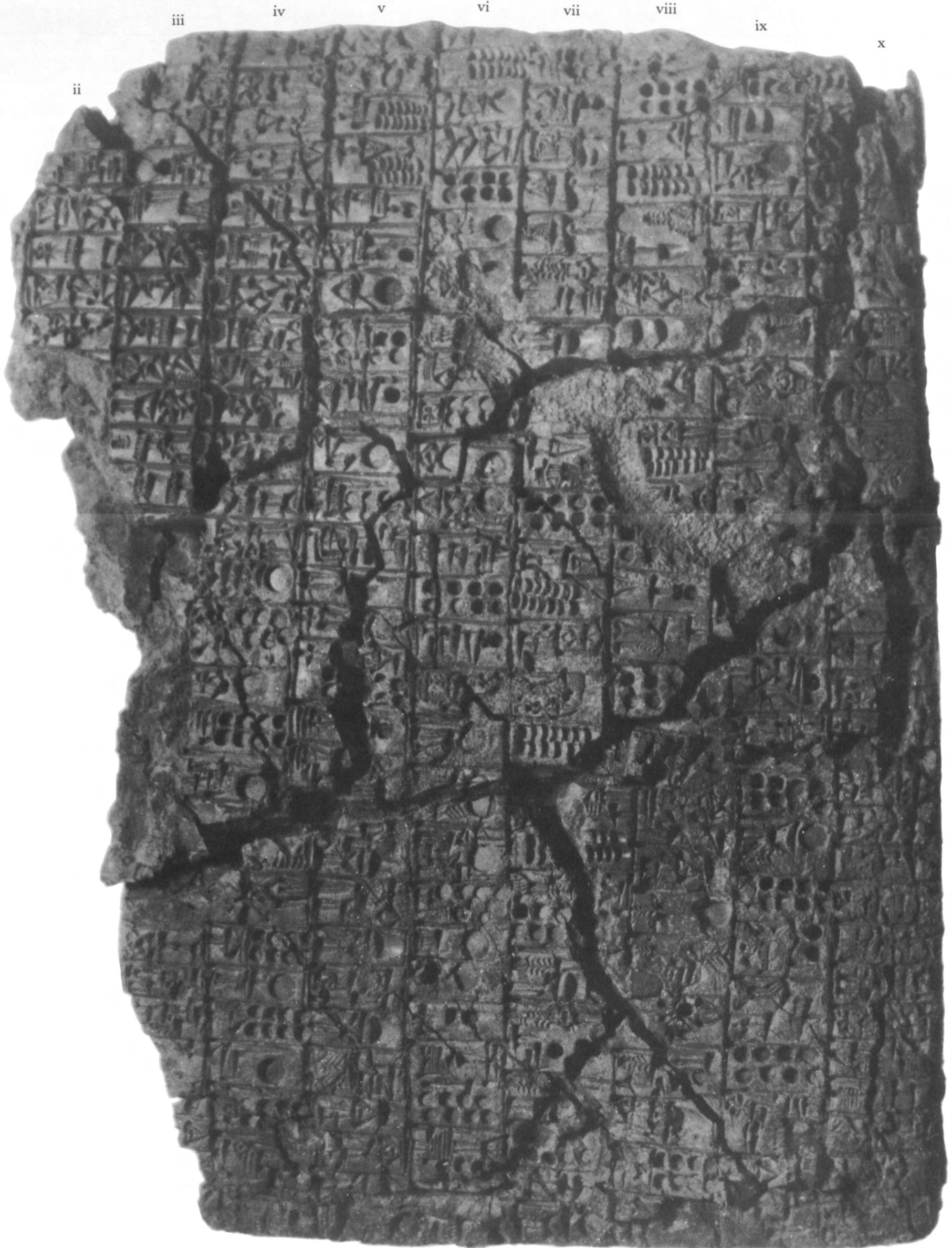

Obverse
No. 128

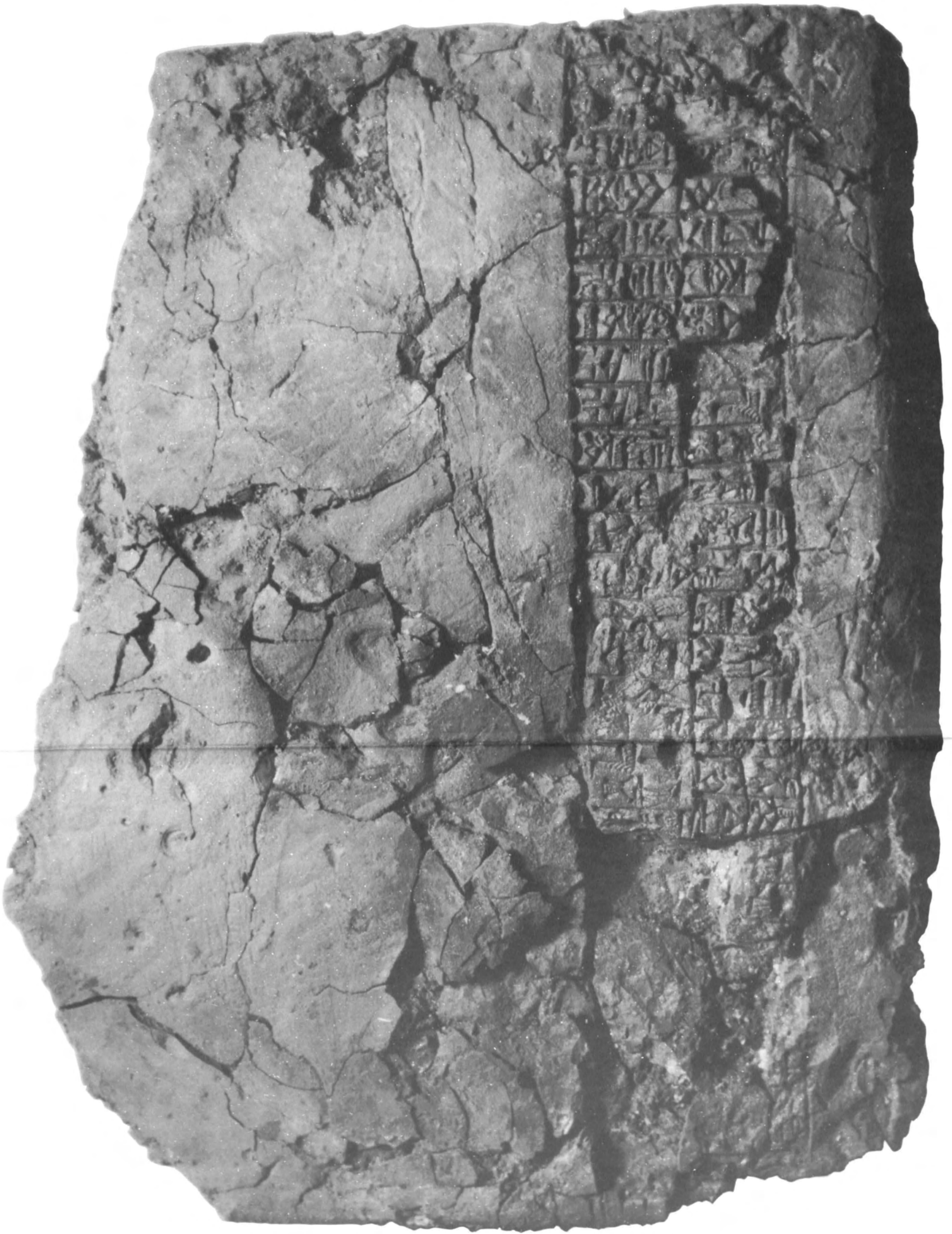

Reverse
No. 128

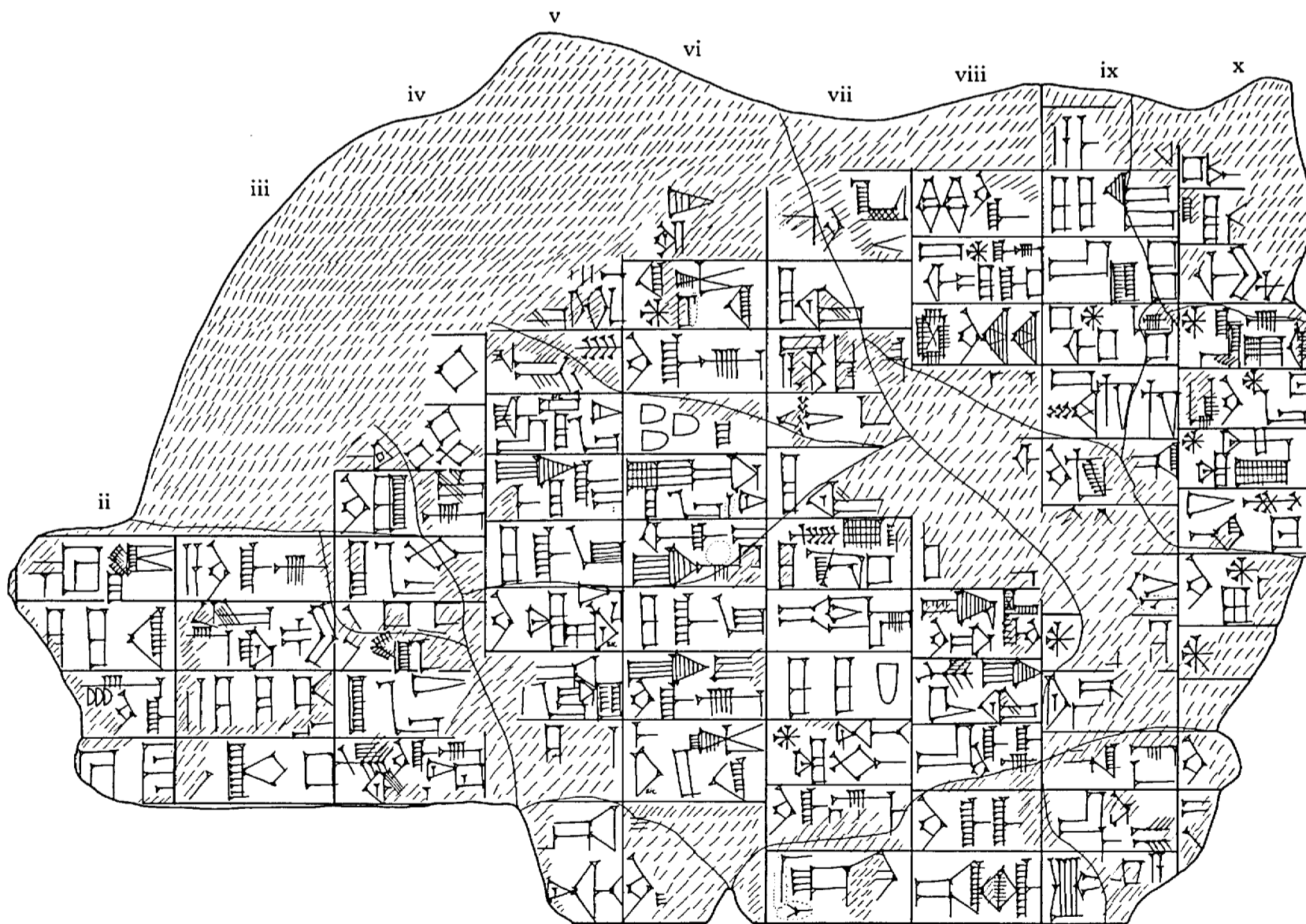

Obverse
No. 129

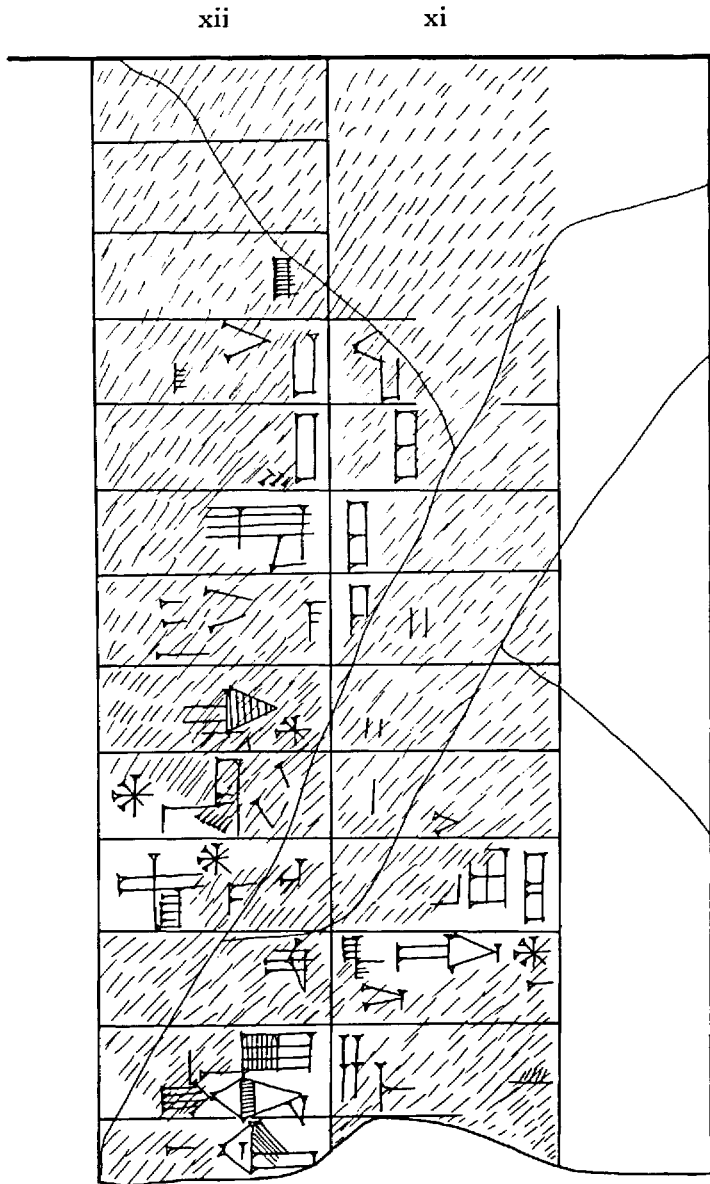

Reverse
No. 129

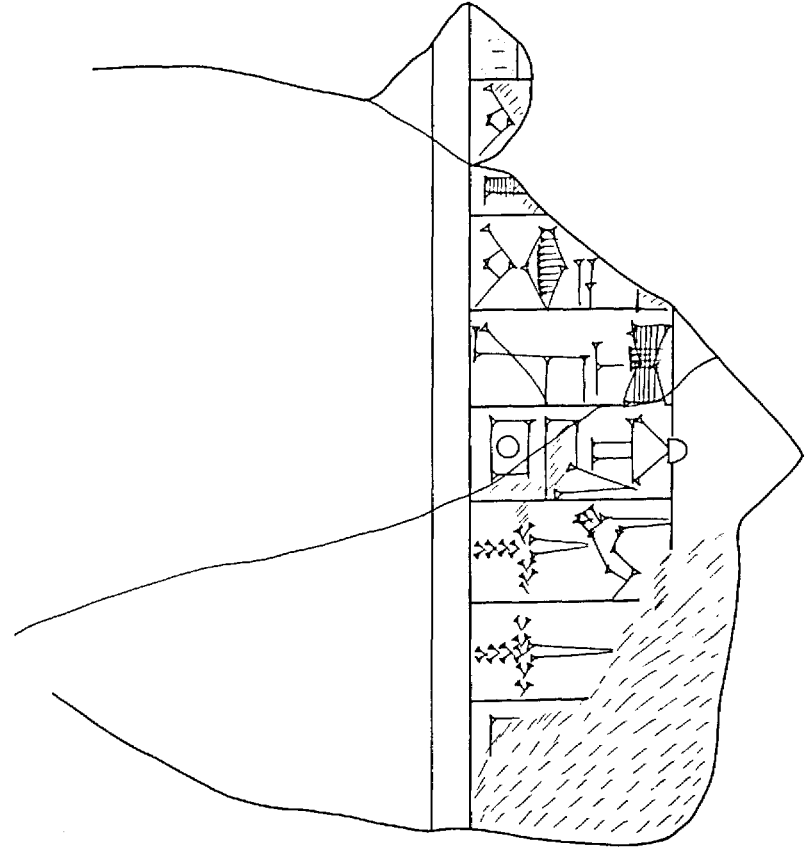

No. 130

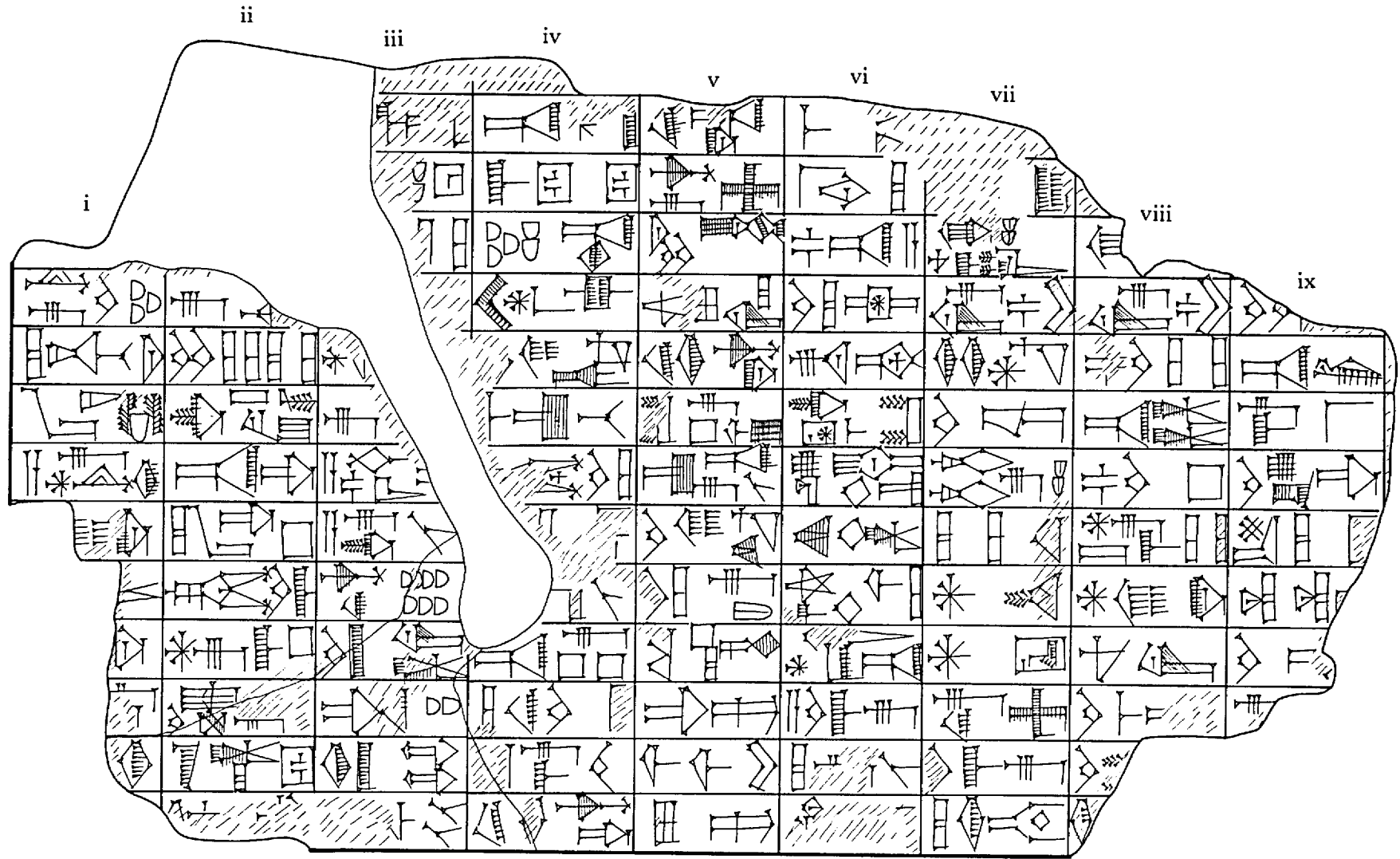

Obverse
No. 131

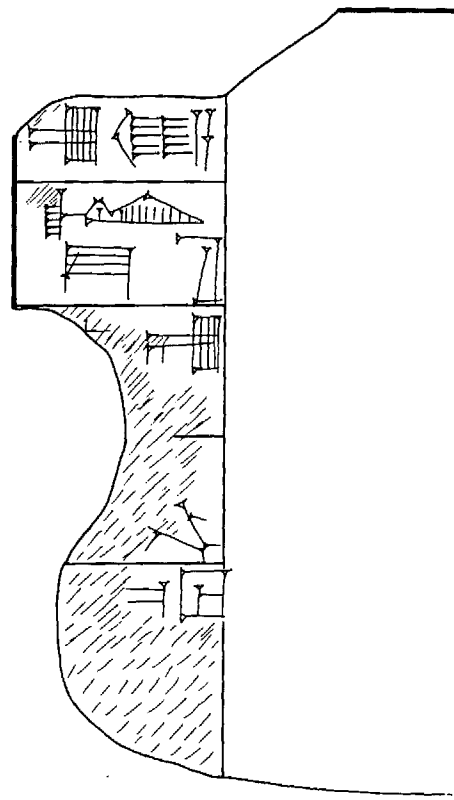

Reverse
No. 131

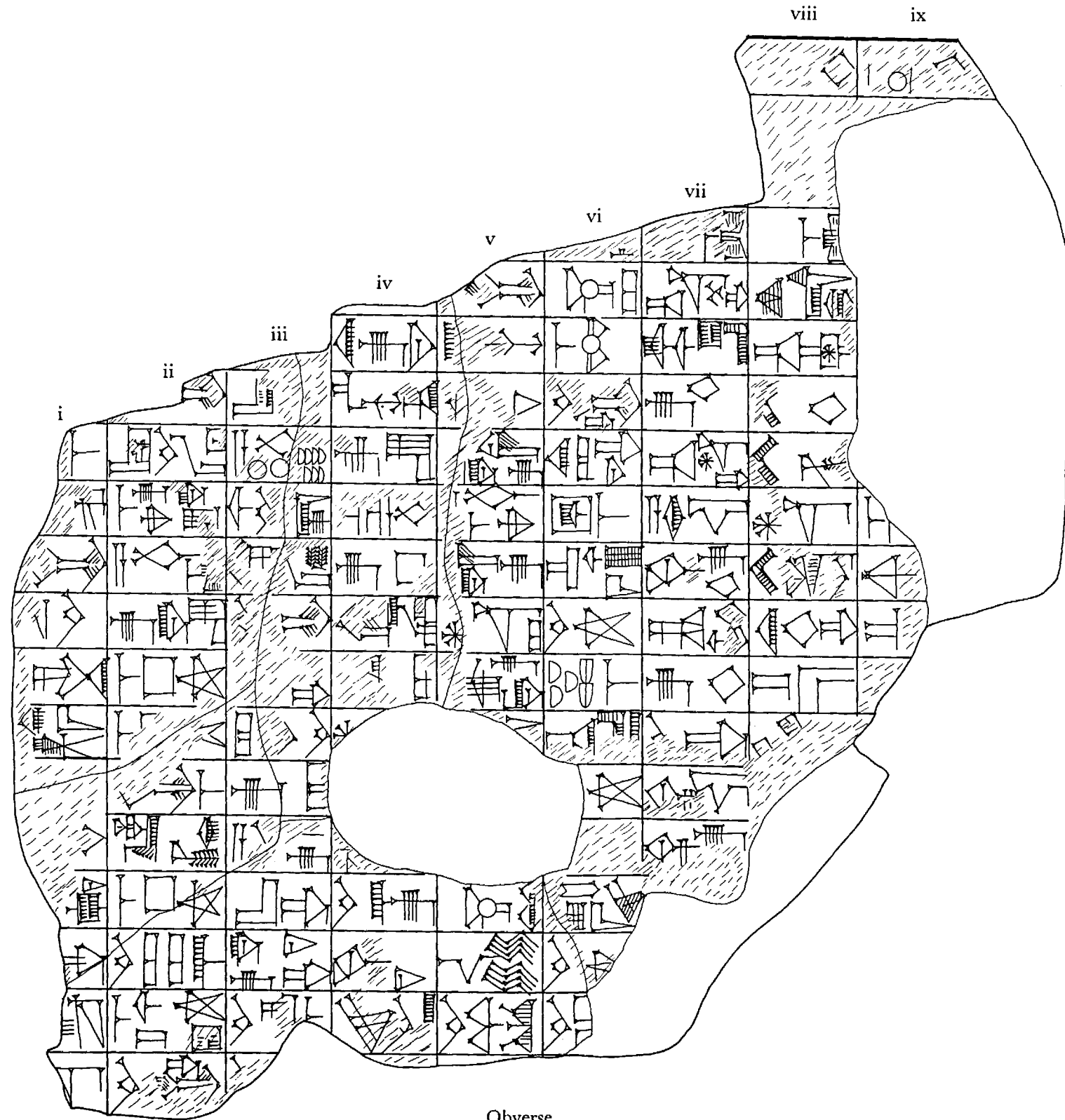

Obverse
No. 132

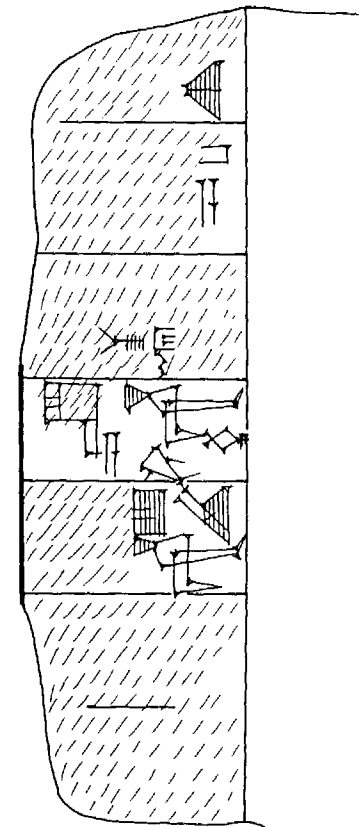

Reverse
No. 132

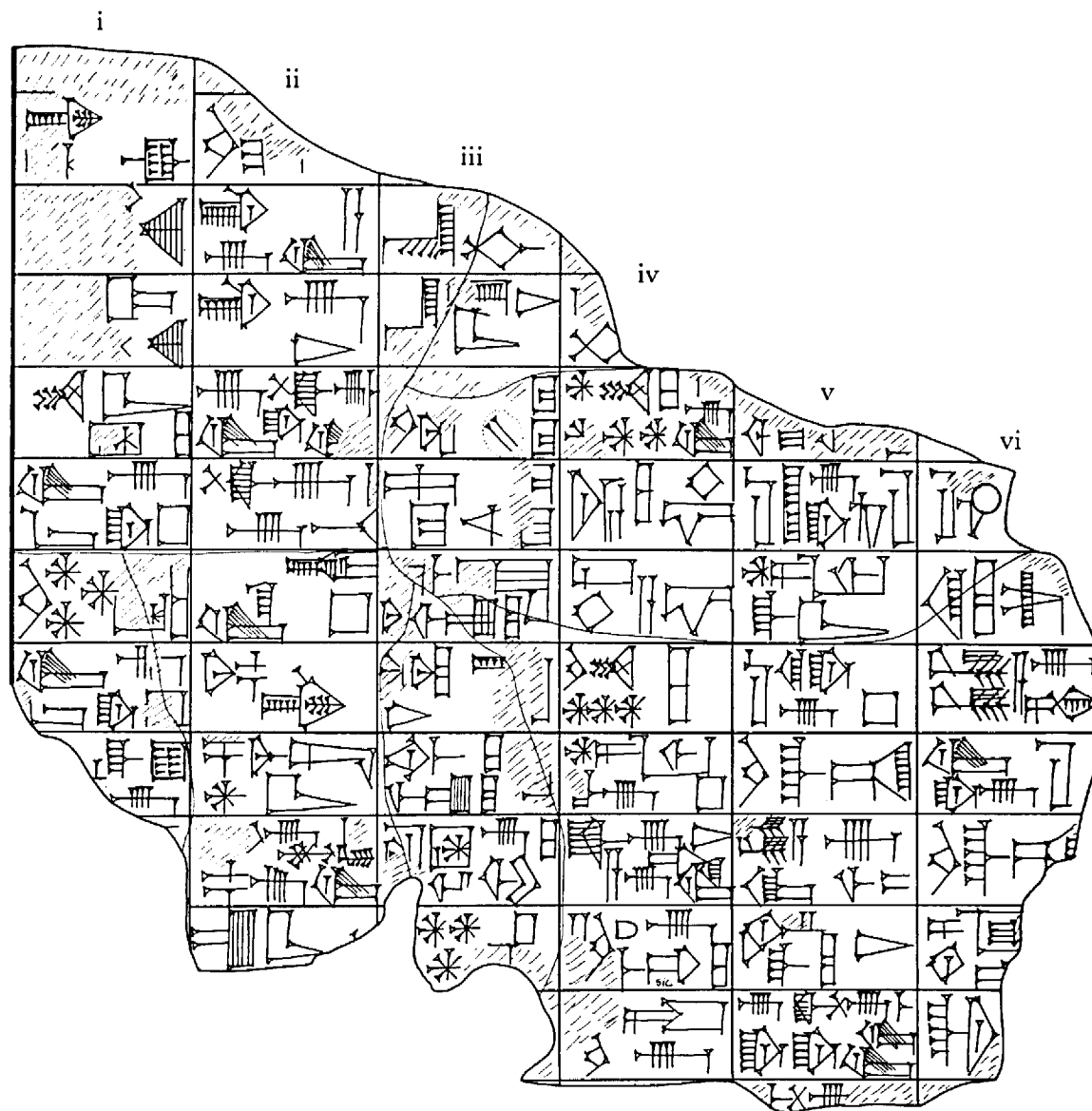

No. 133

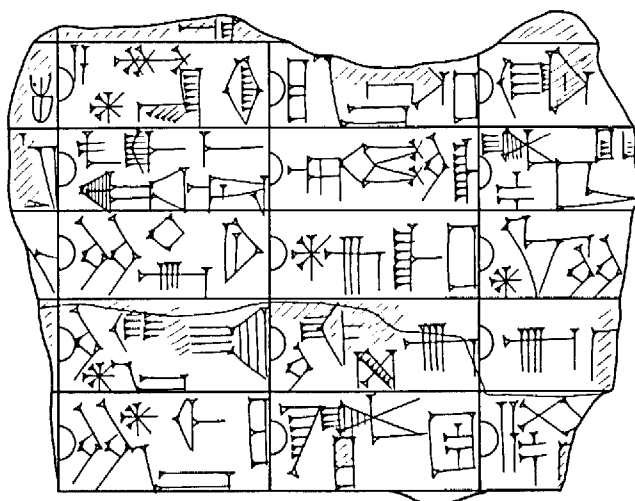

No. 134

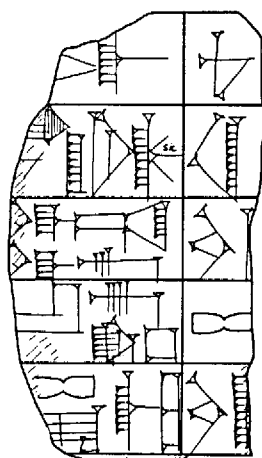

No. 135

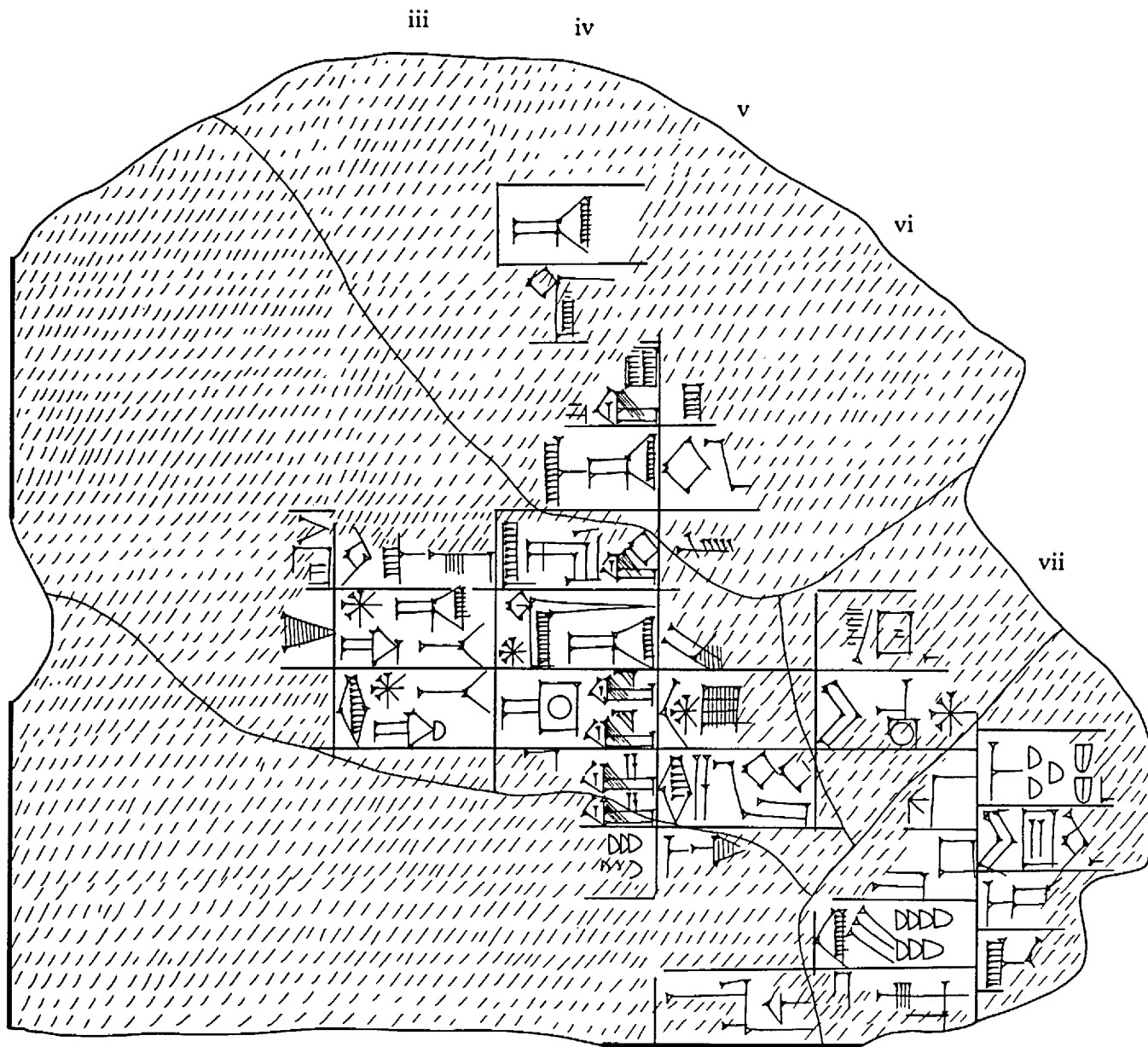

No. 136

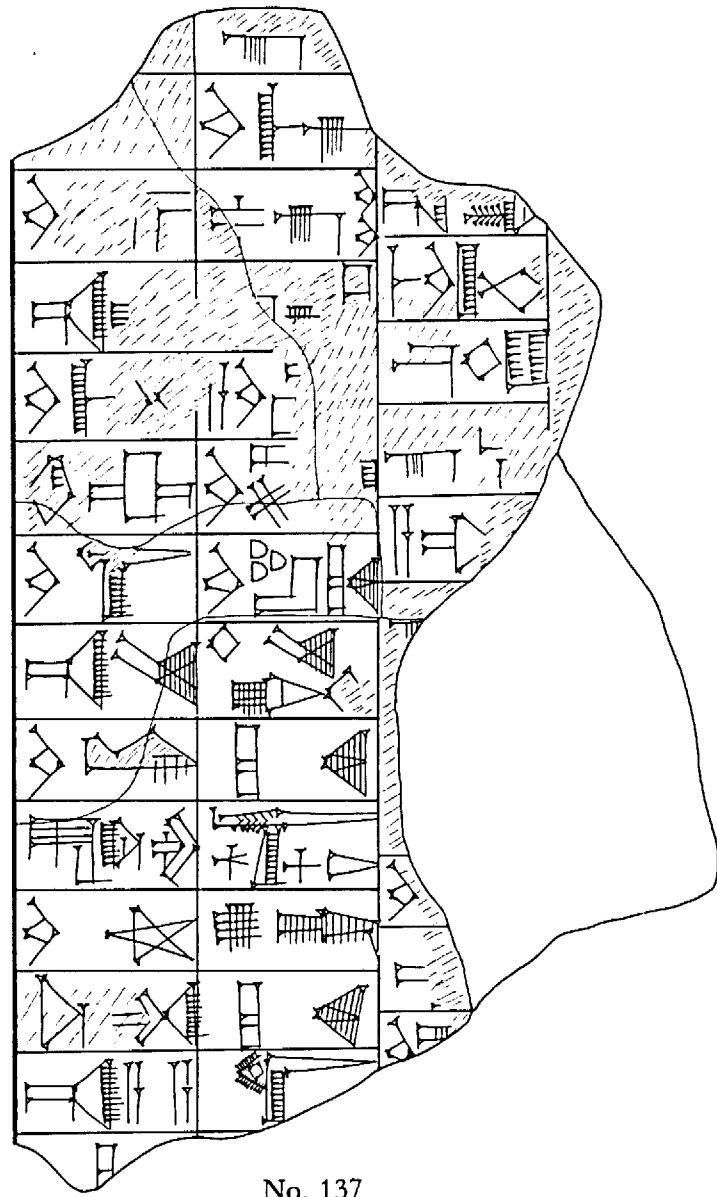

No. 137

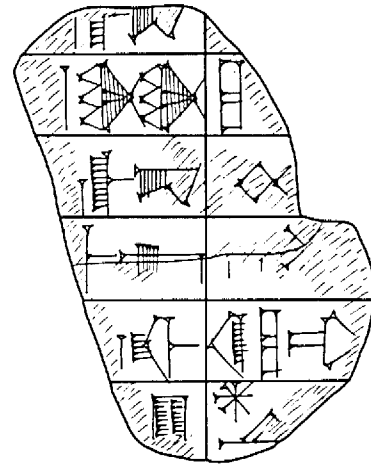

No. 138

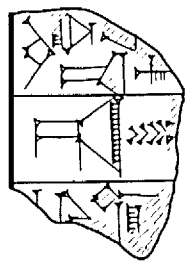

No. 139

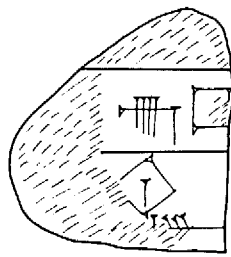

No. 140

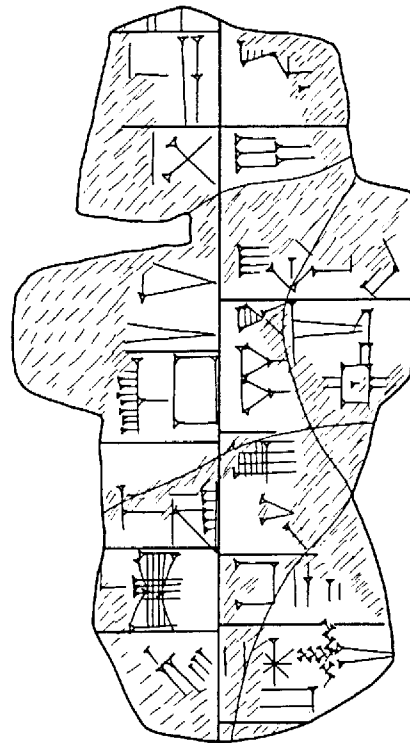

No. 141



Obverse
No. 142

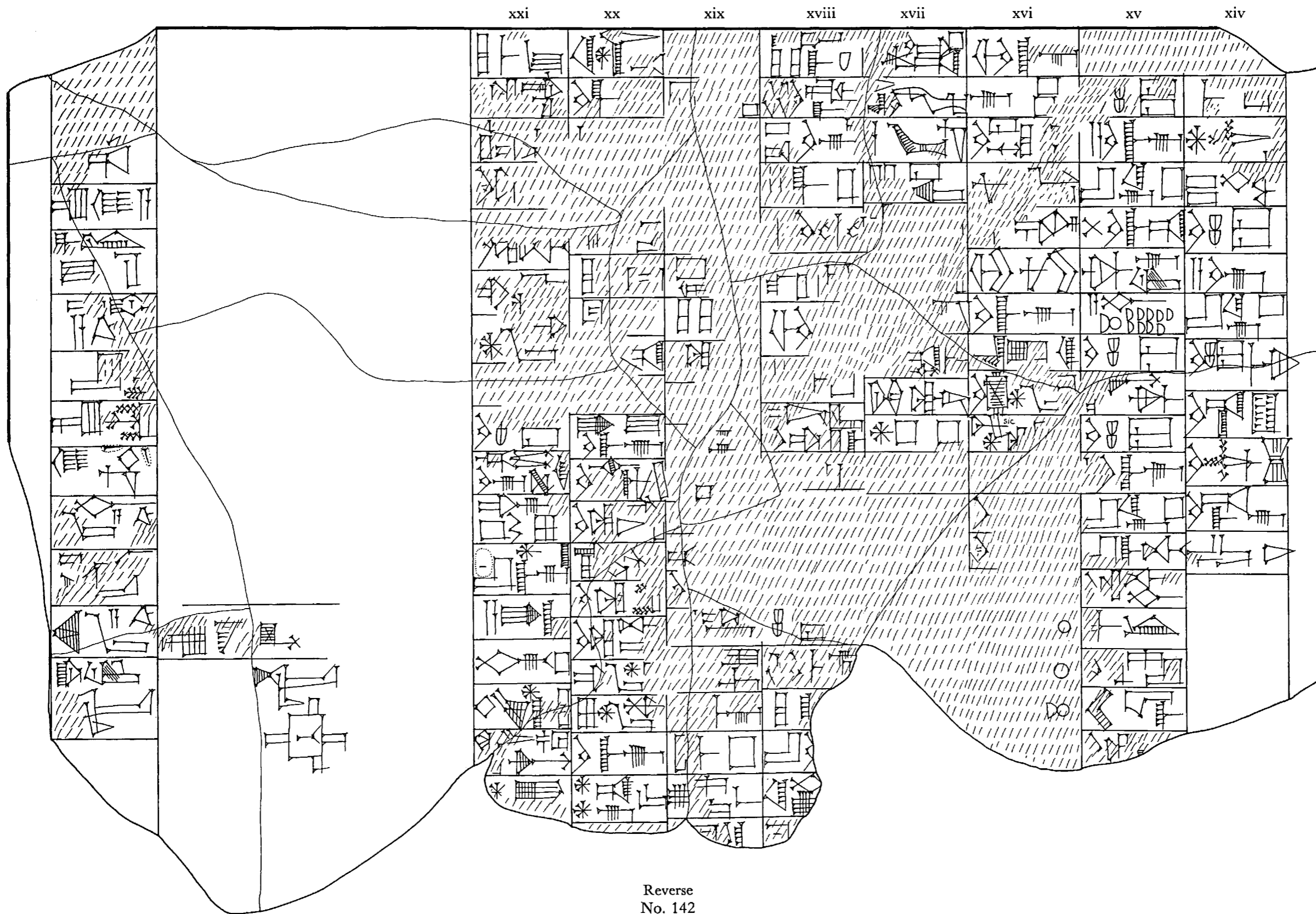

Reverse
No. 142

PLATE 84

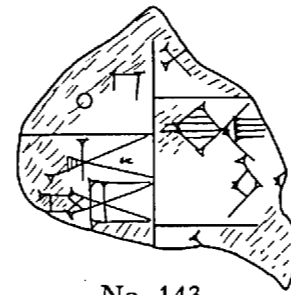

No. 143



No. 144

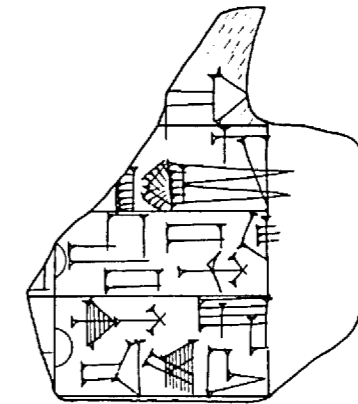

No. 145

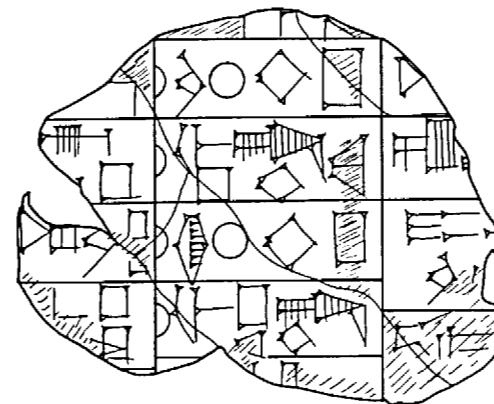

No. 146

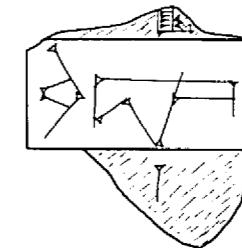

No. 147

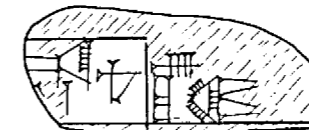

No. 148

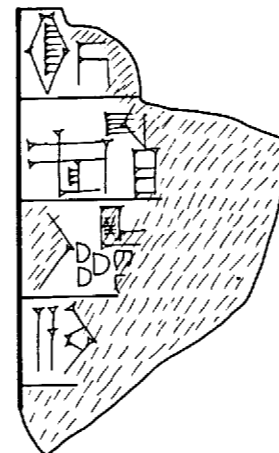

No. 149

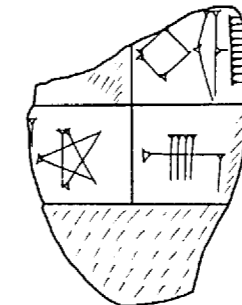

No. 150

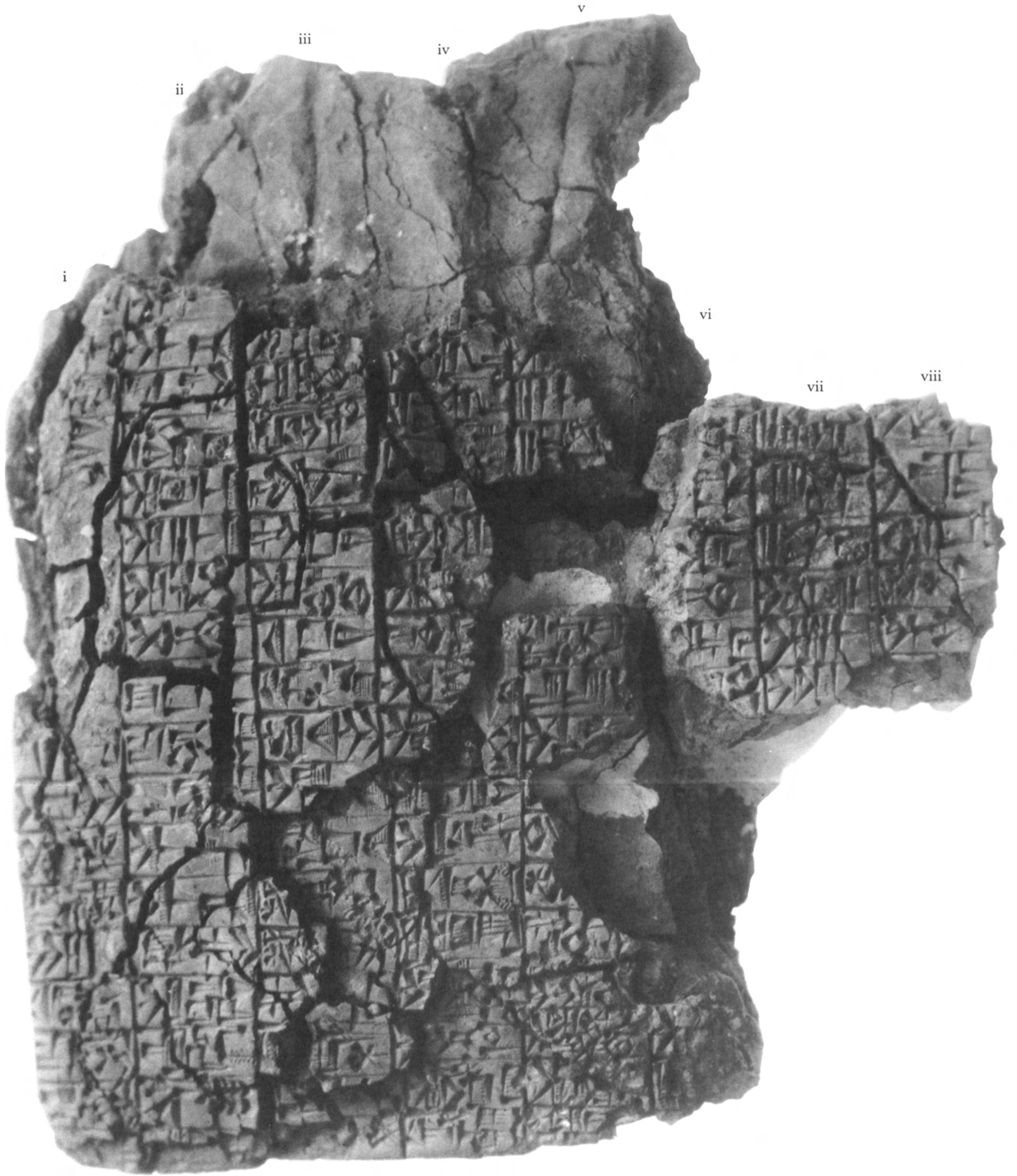

No. 151

PLATE 86

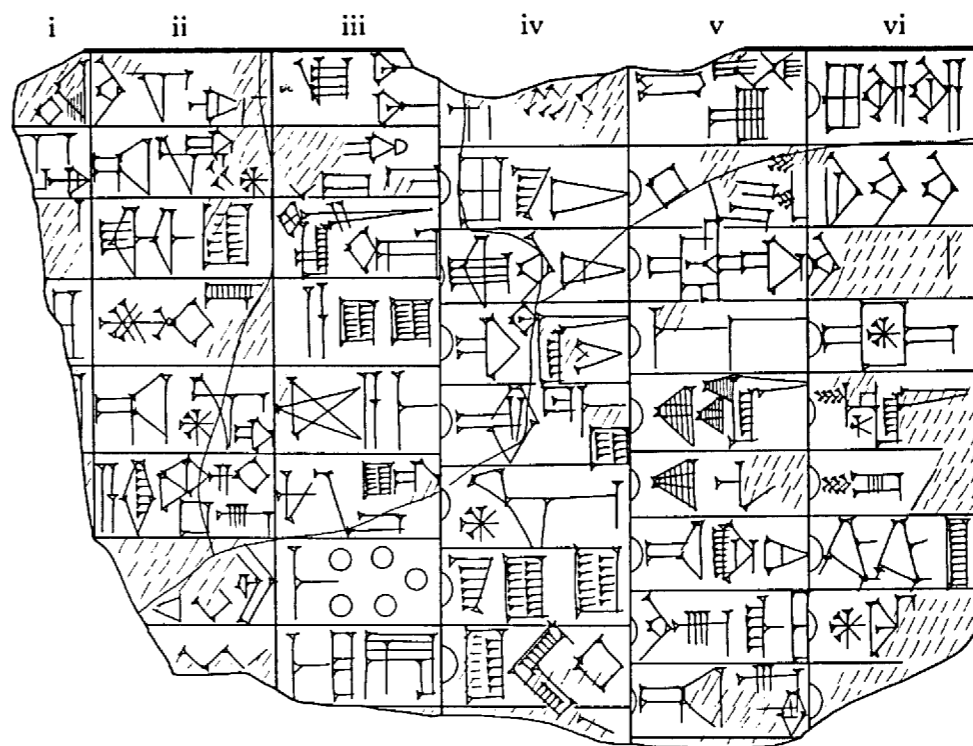

No. 152

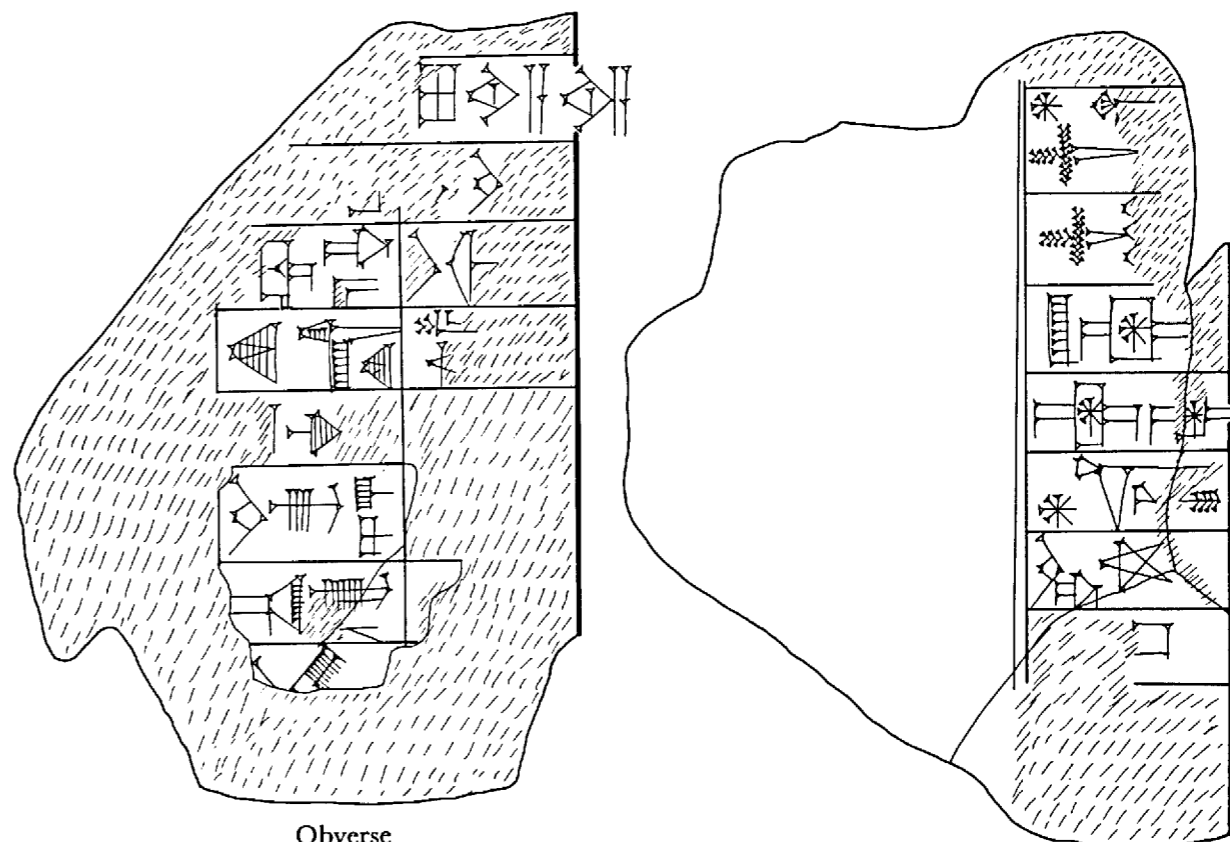

Obverse
No. 153

Reverse
No. 153

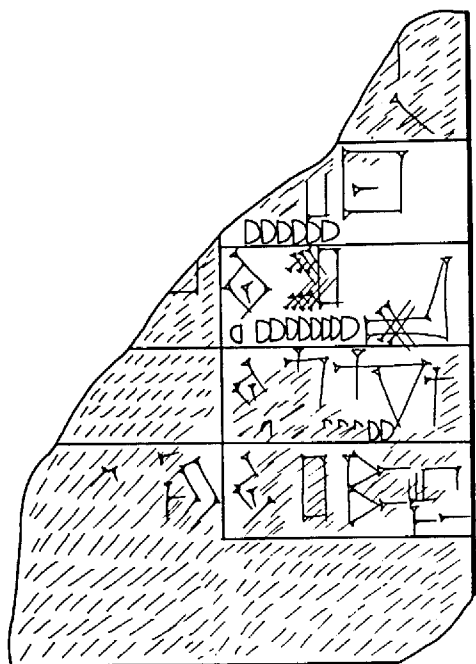

No. 154

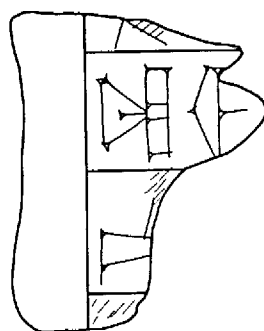

No. 155

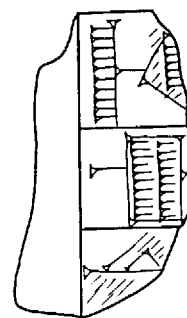

No. 156

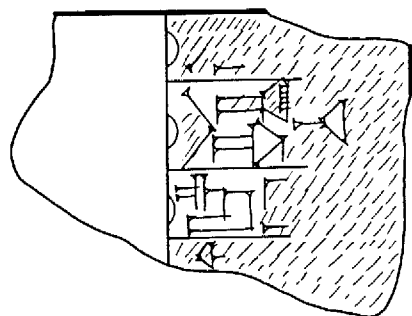

No. 157

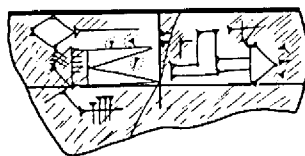

No. 158

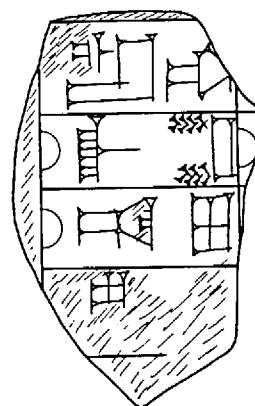

No. 159

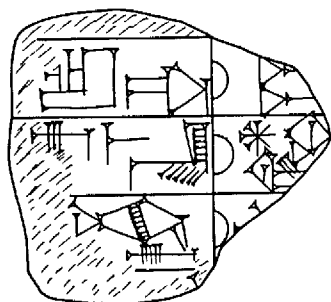

No. 160

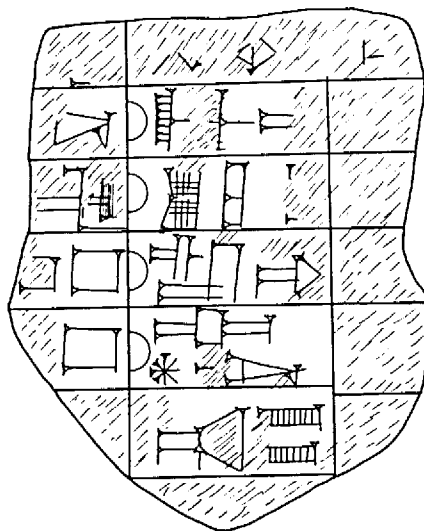

No. 161

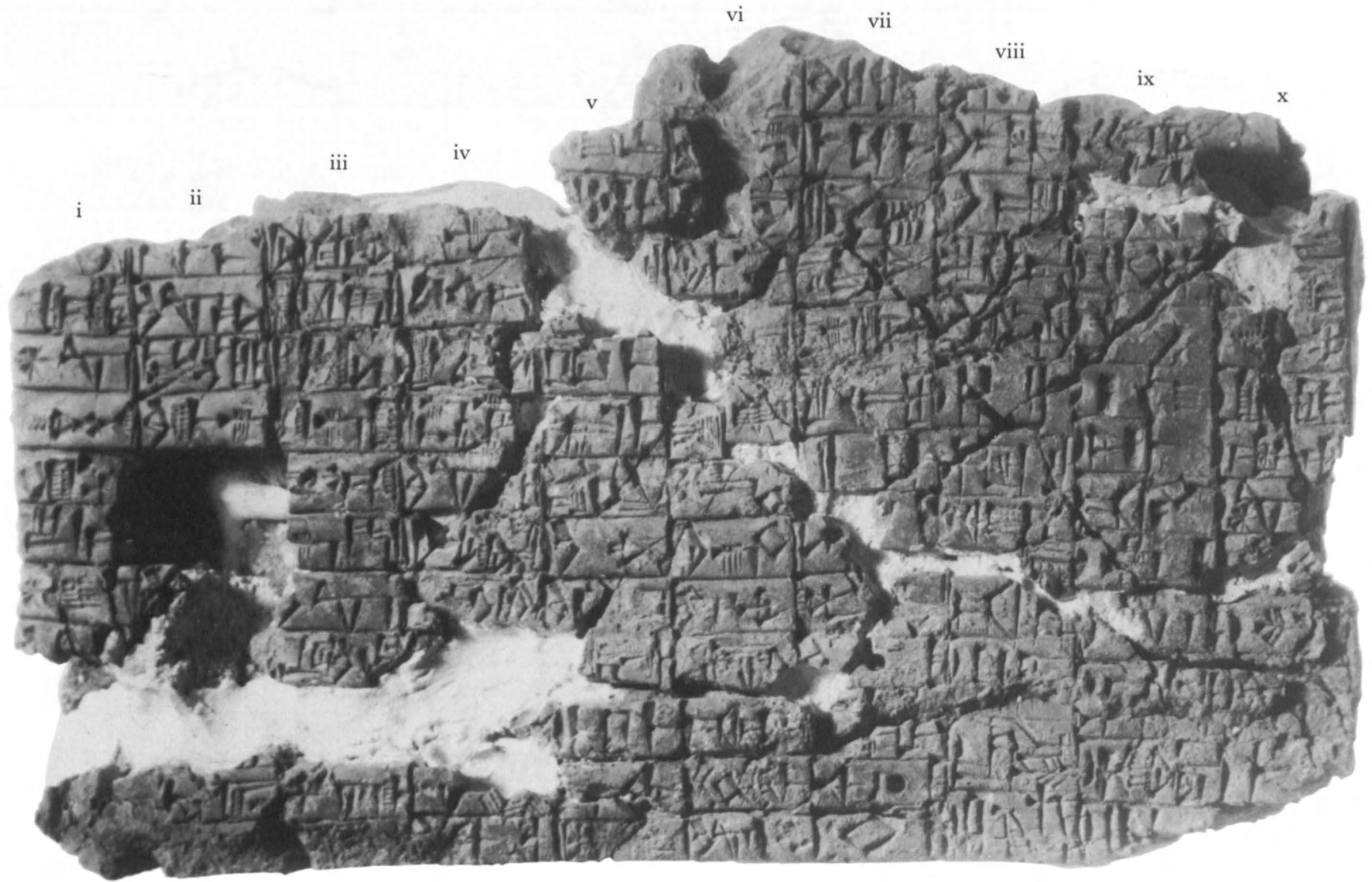

No. 162

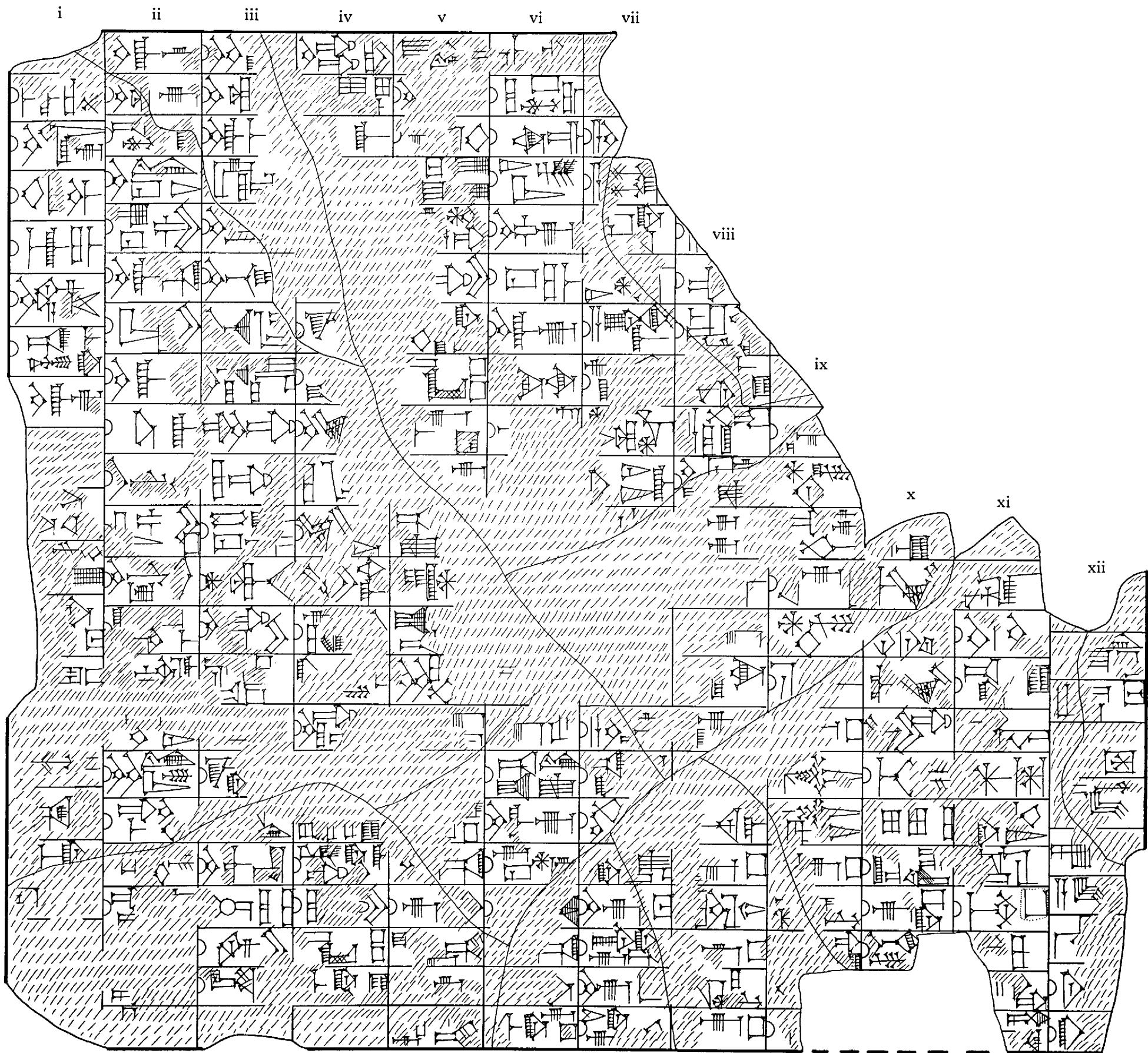

No. 163

PLATE 90

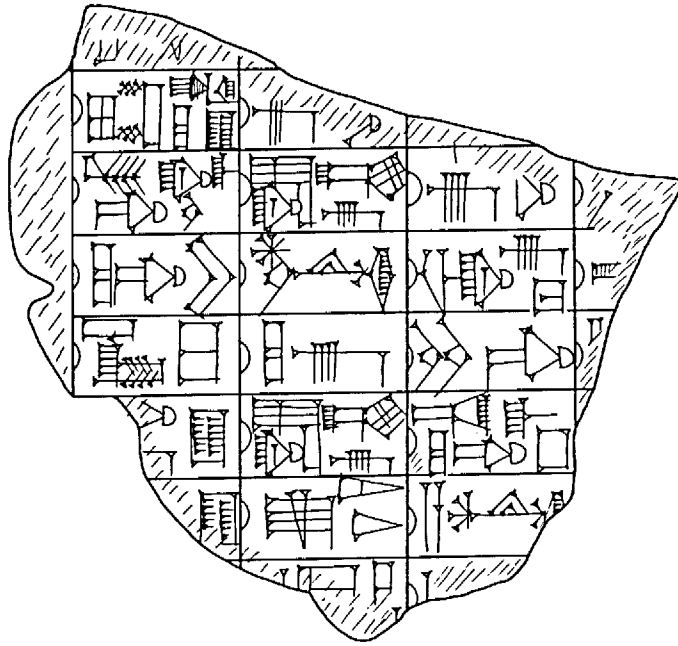

No. 164

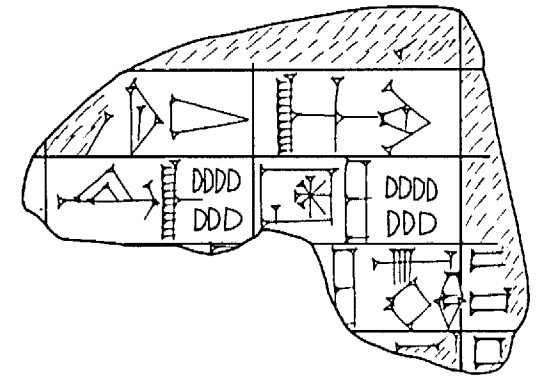

No. 165

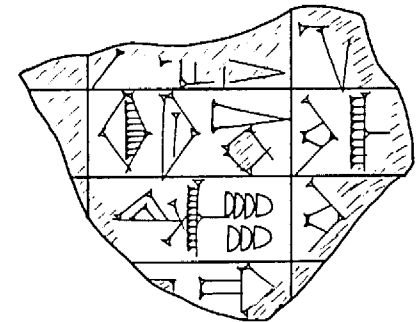

No. 166

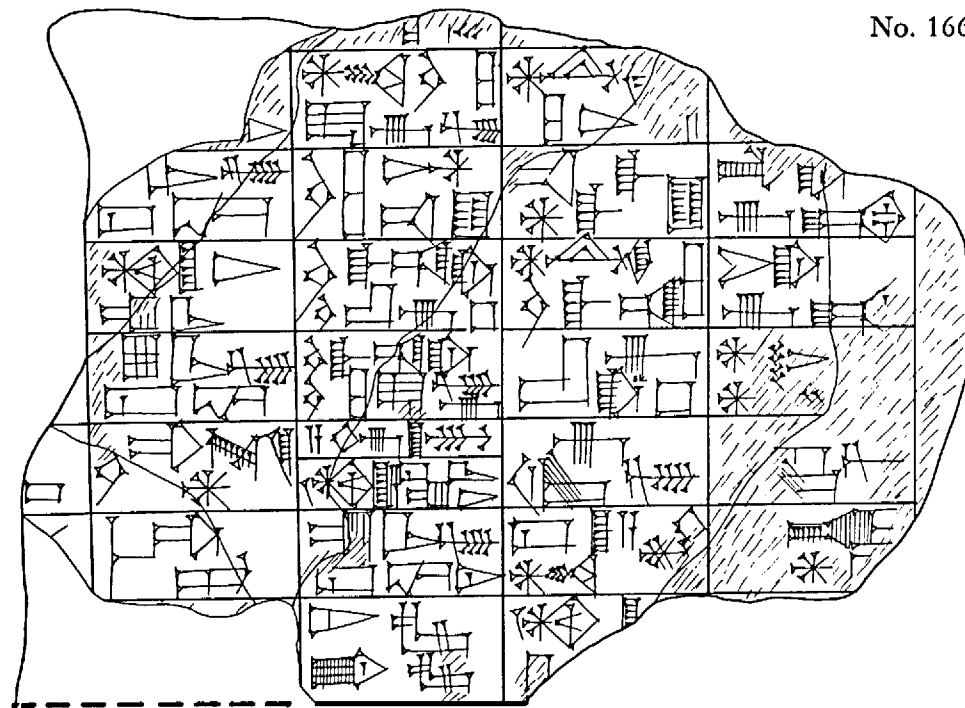

No. 167

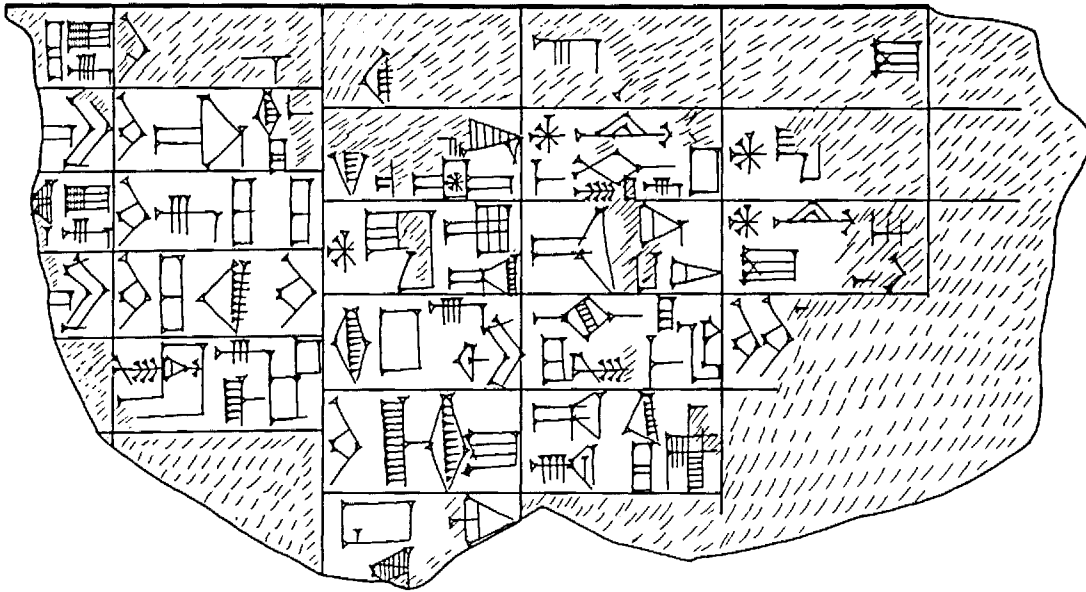

No. 168

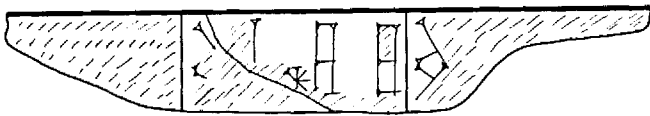

No. 169

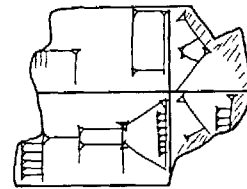

No. 170

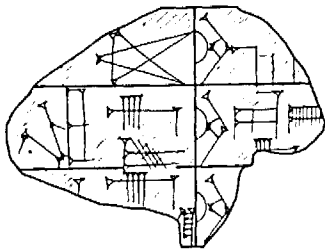

No. 171

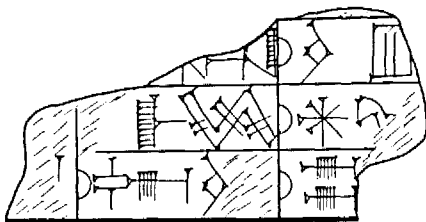

No. 172

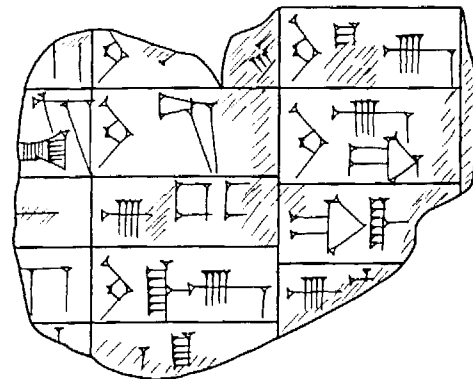

No. 173

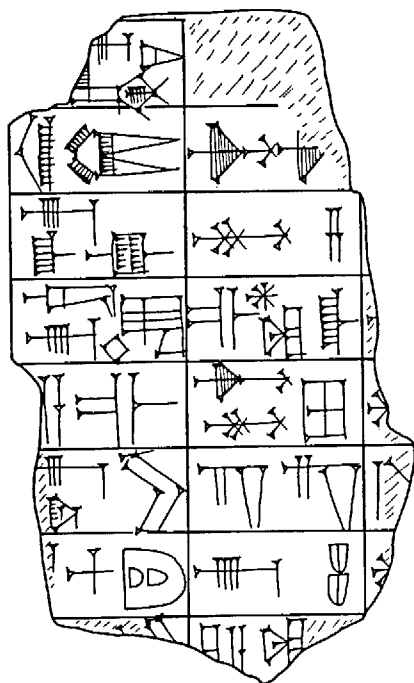

No. 174

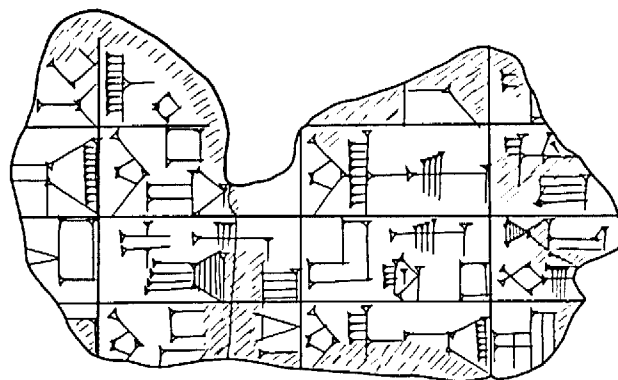

No. 175

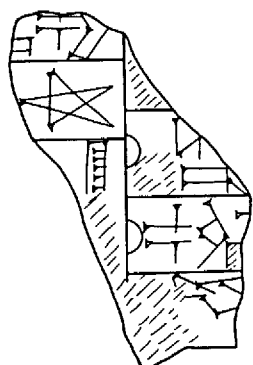

No. 176

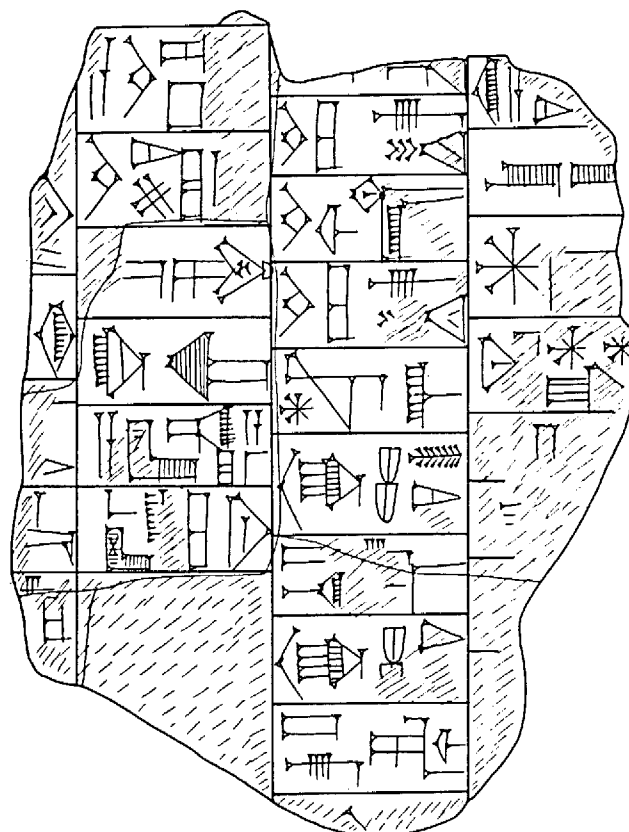

No. 177

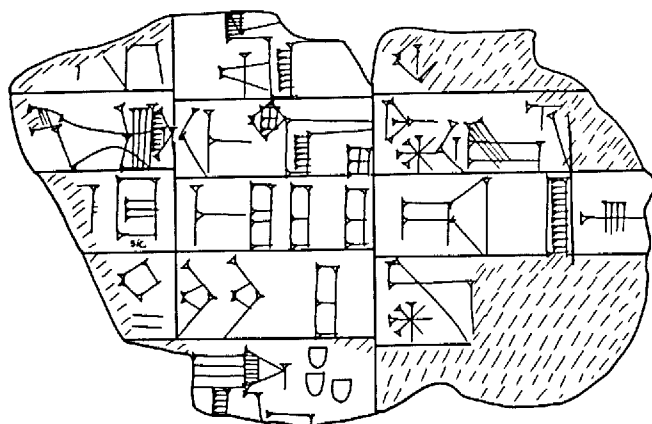

No. 178

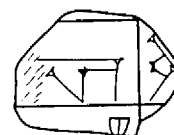

No. 179

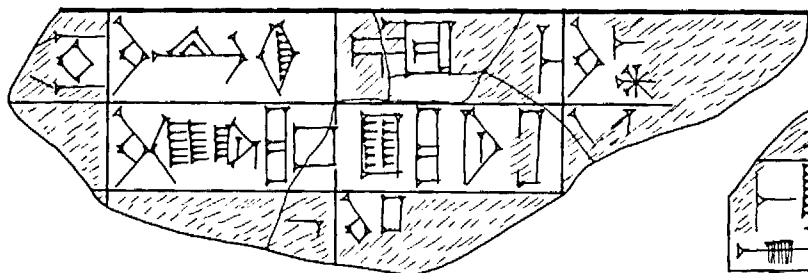

No. 180

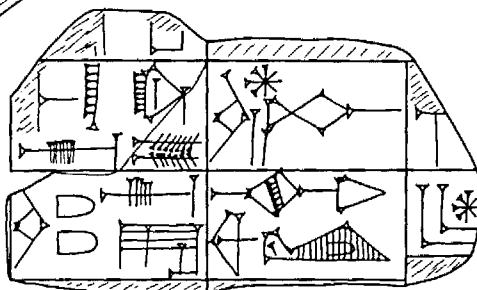

No. 181

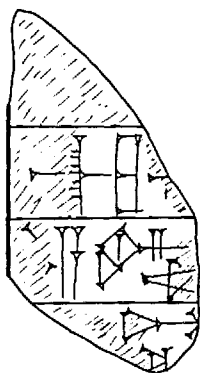

No. 182

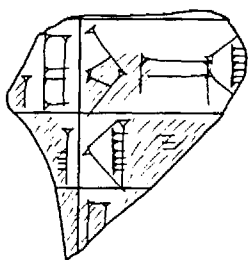

No. 183

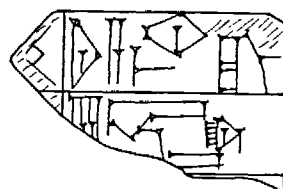

No. 184

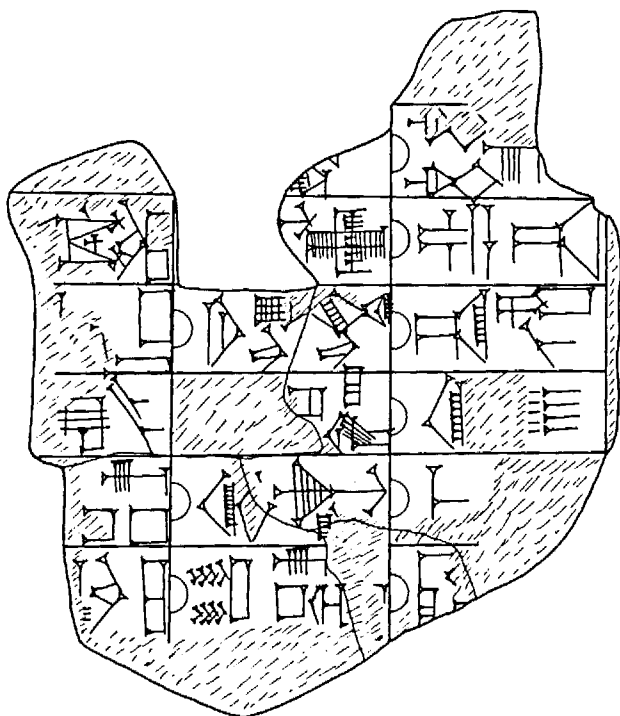

No. 185

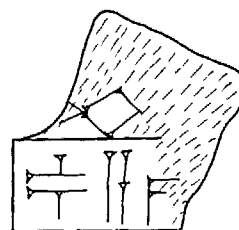

No. 186

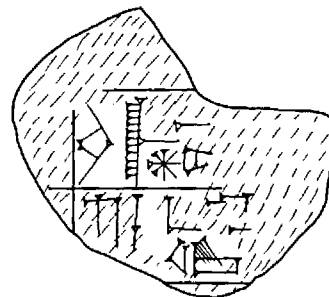

No. 187

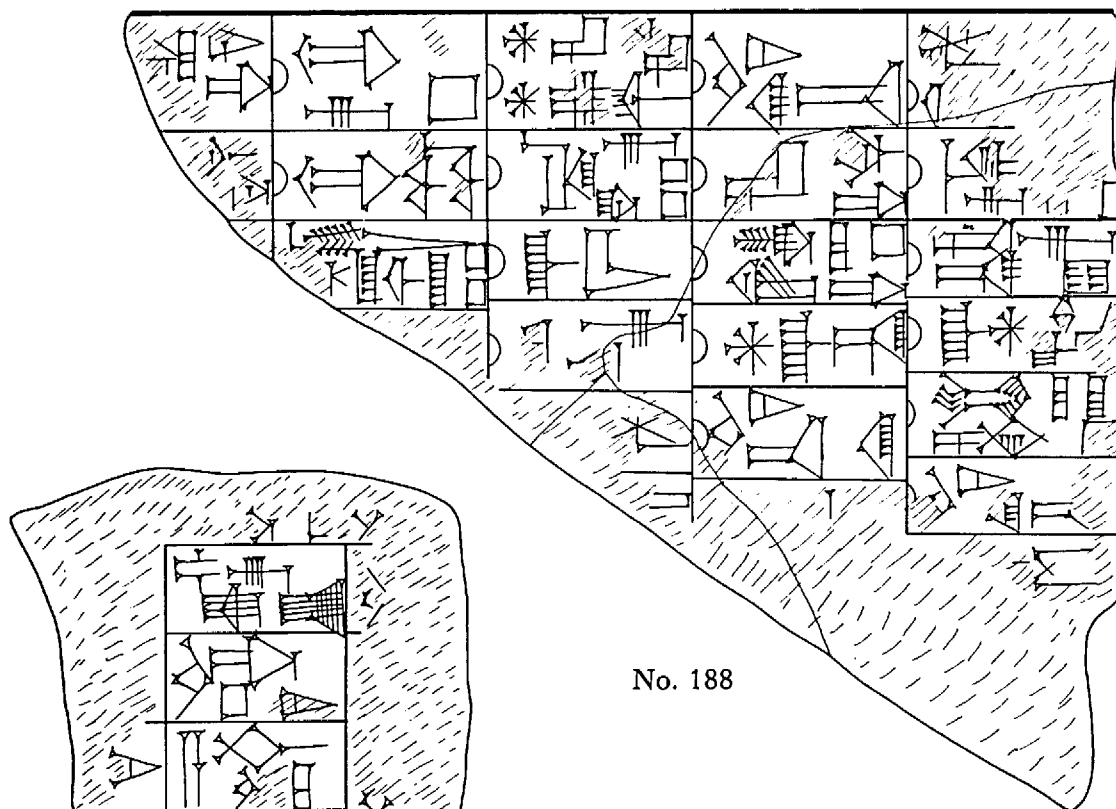

No. 188

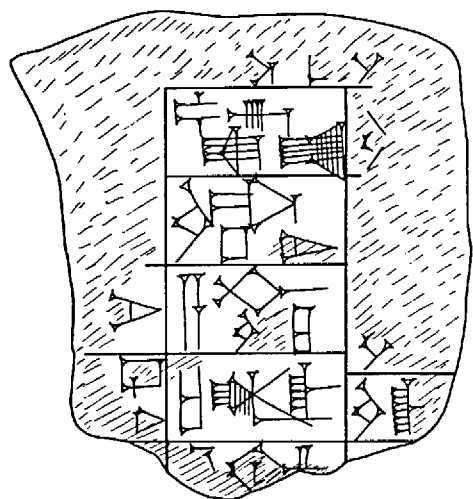

No. 189

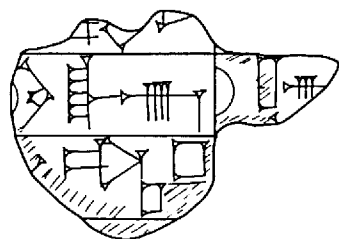

No. 190

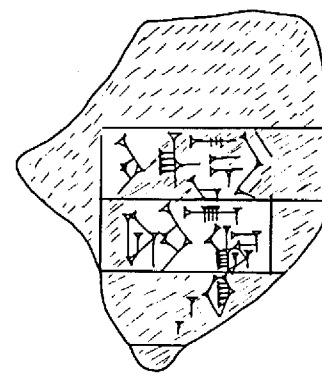

No. 191

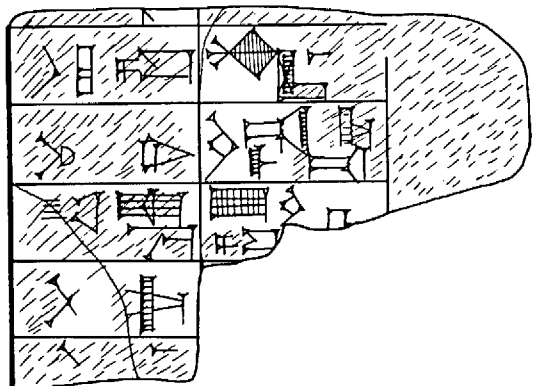

No. 192

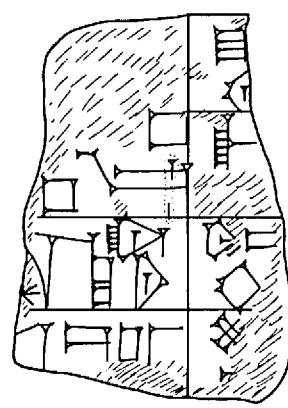

No. 193

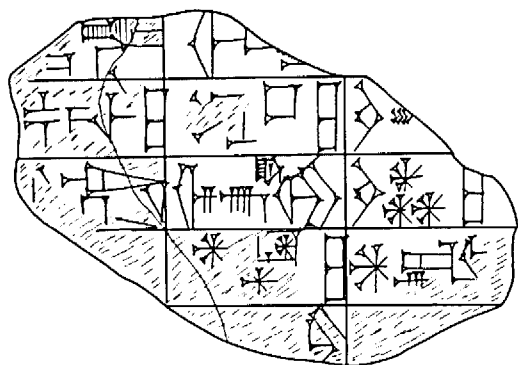

No. 194

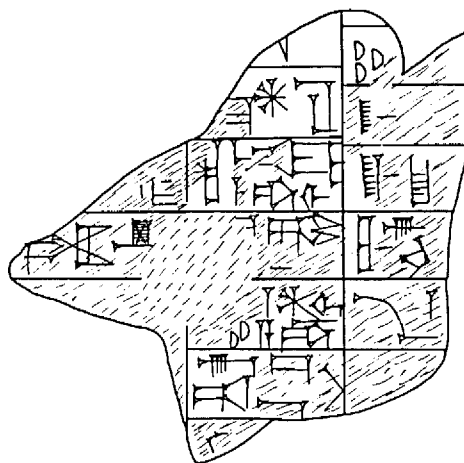

No. 195

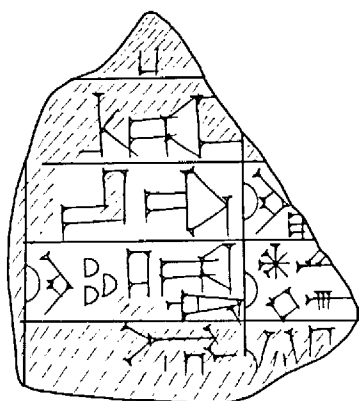

No. 196

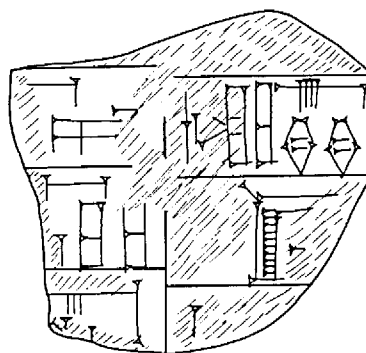

No. 197

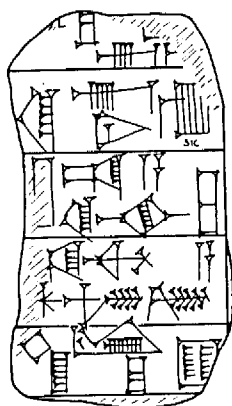

No. 198

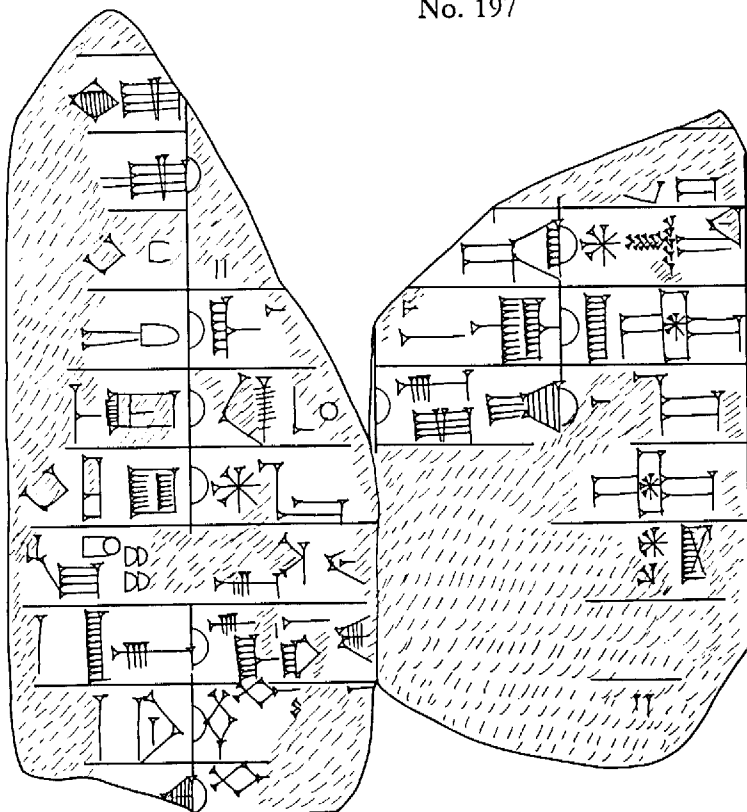

No. 199

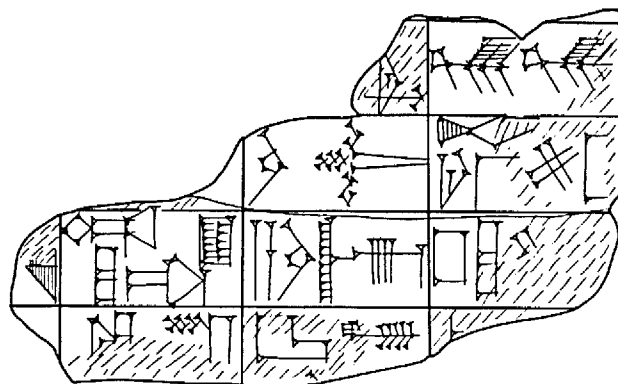

No. 200

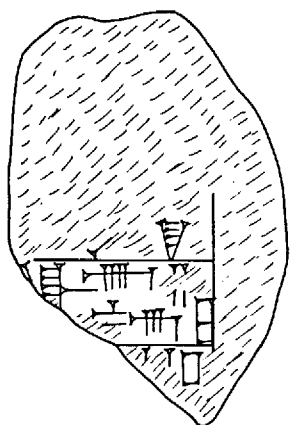

No. 202

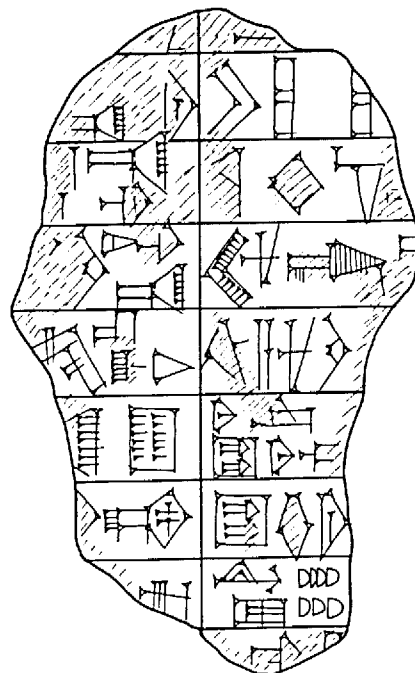

No. 201

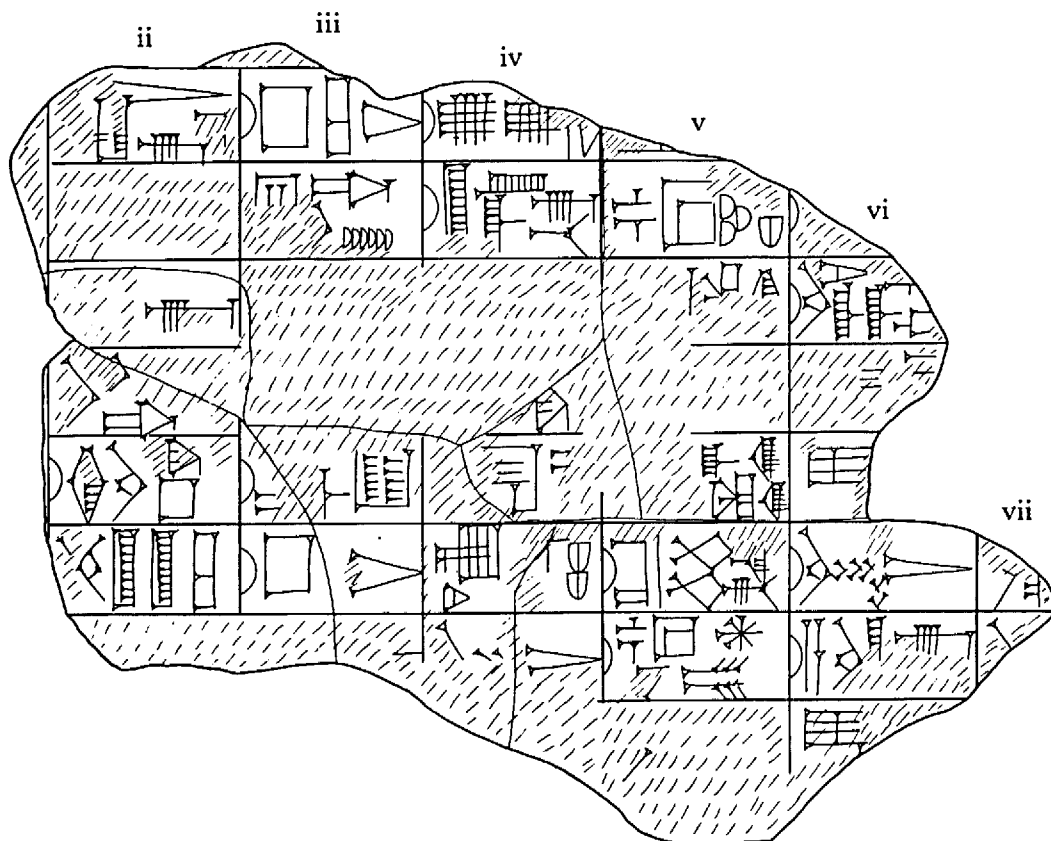

No. 203

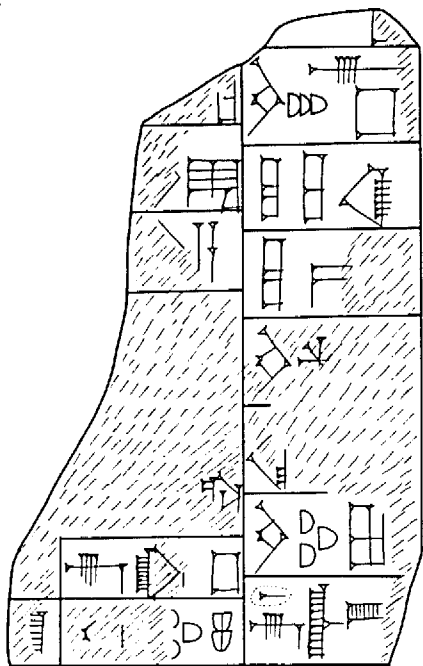

Obverse
No. 204

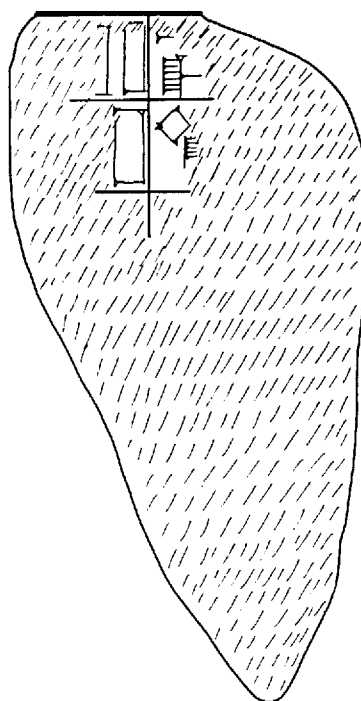

Reverse
No. 204

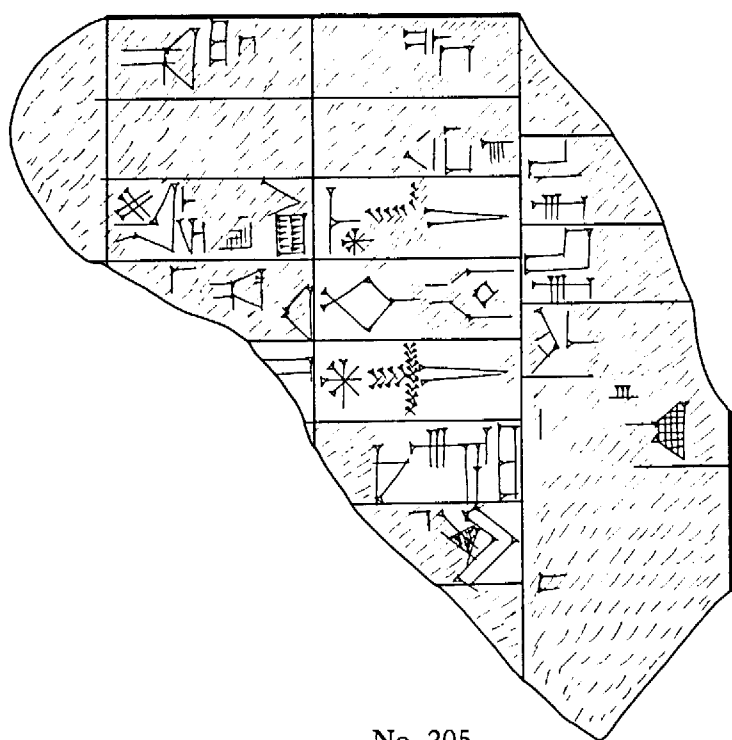

No. 205

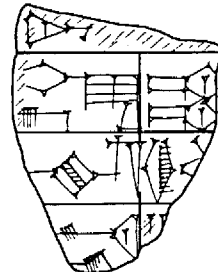

No. 206

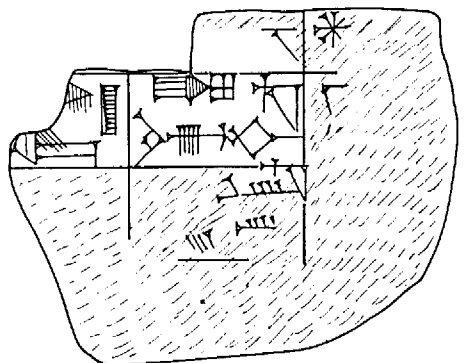

No. 207

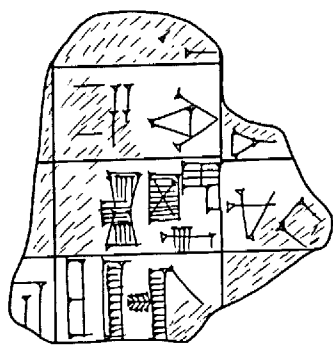

No. 208

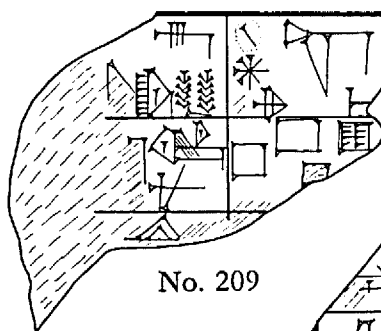

No. 209

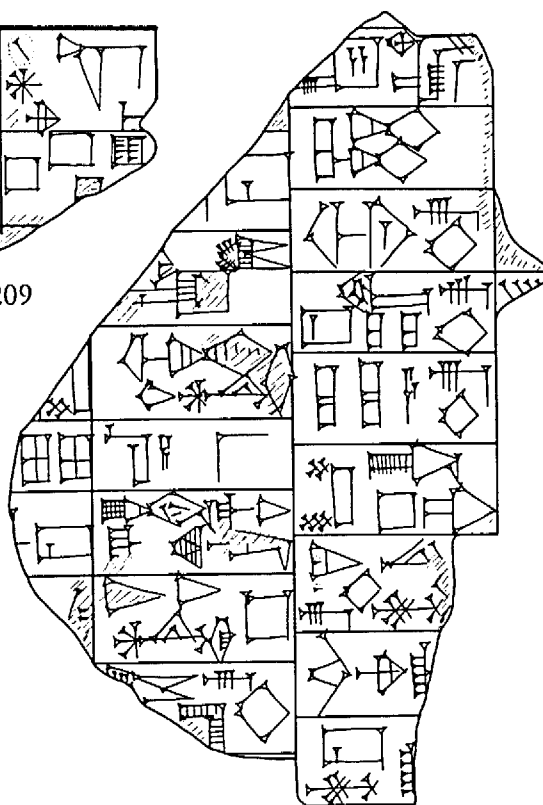

No. 210

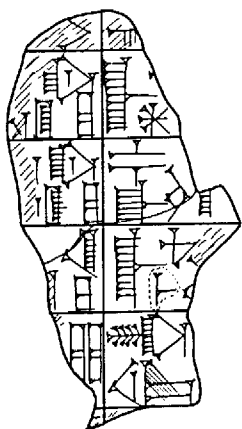

No. 211

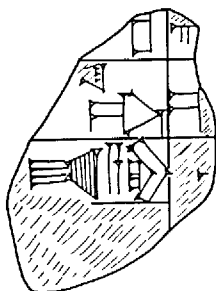

No. 212

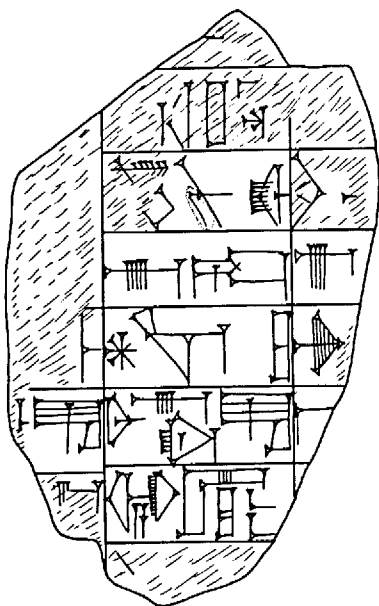

No. 213

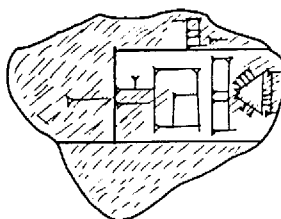

No. 214

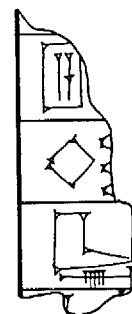

No. 215

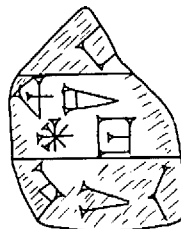

No. 216

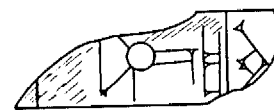

No. 217

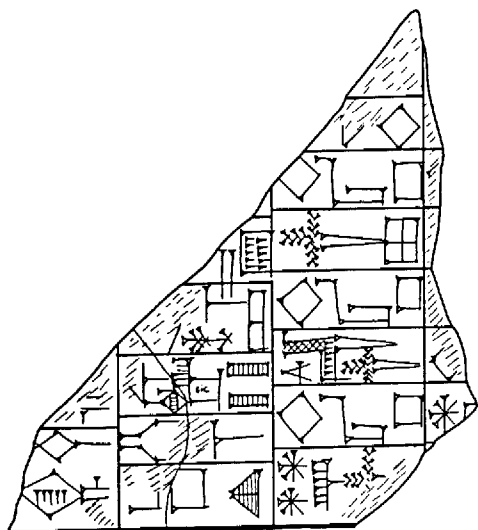

Obverse
No. 218

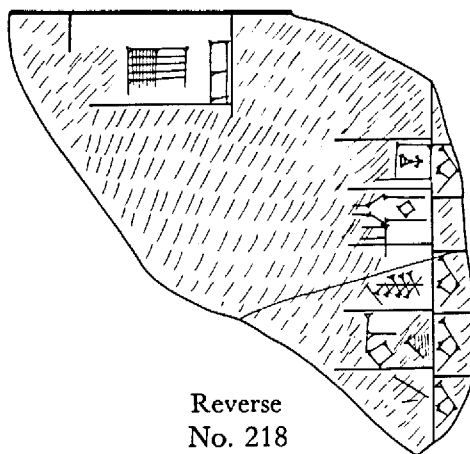

Reverse
No. 218

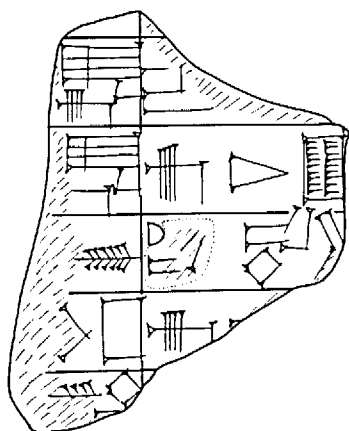

No. 219

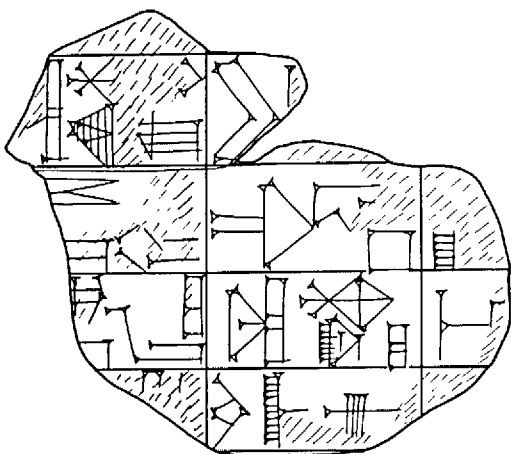

No. 221

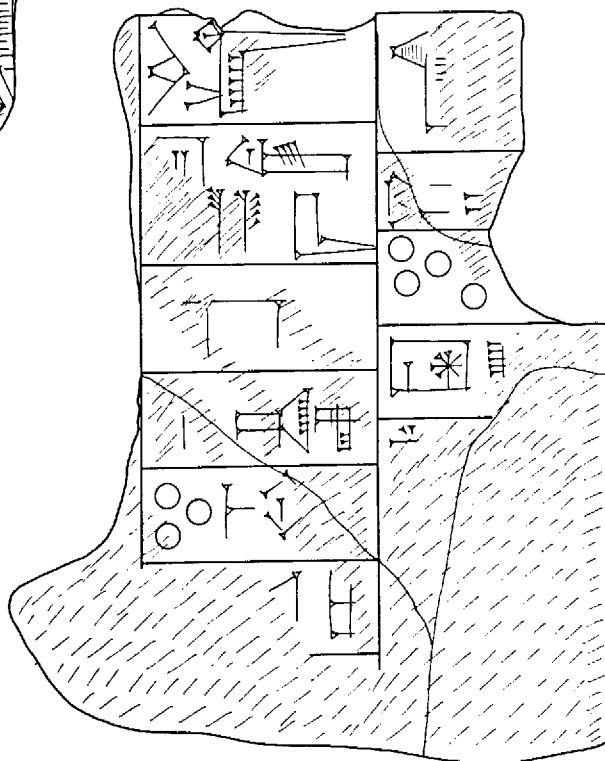

No. 220

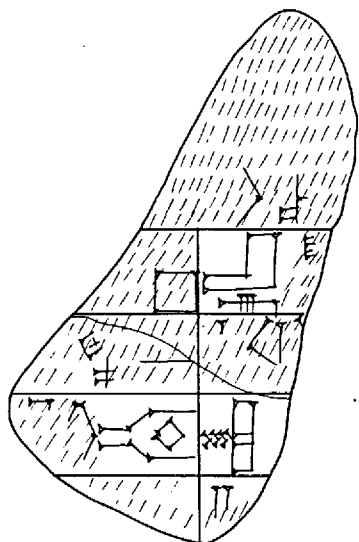

No. 222

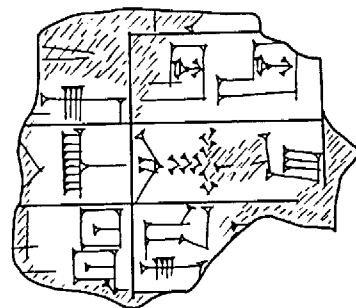

No. 223

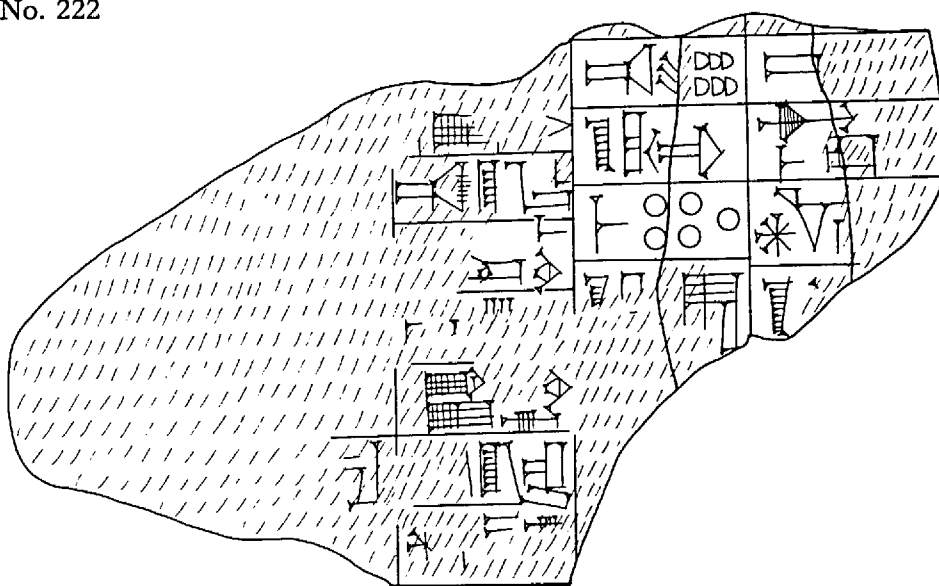

No. 224

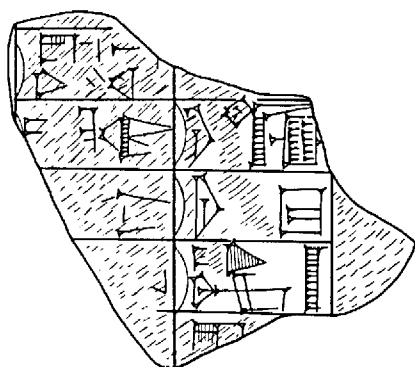

No. 225

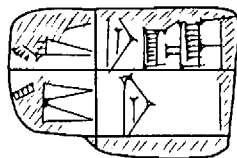

No. 226

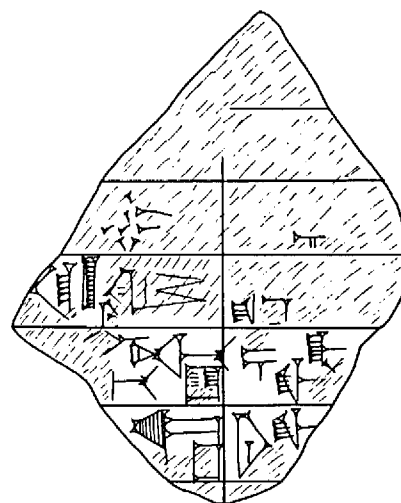

No. 227

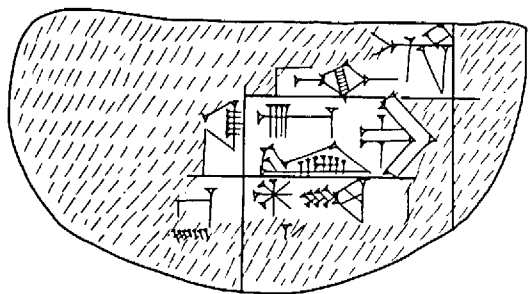

No. 228

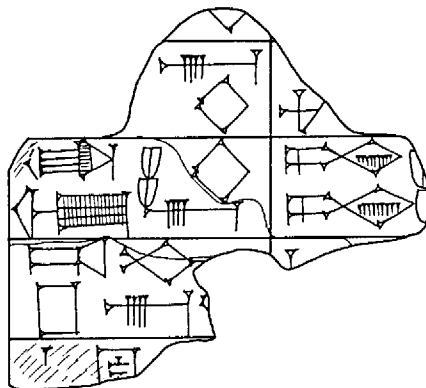

No. 229

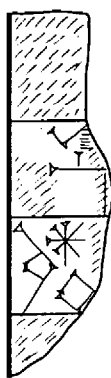

No. 230

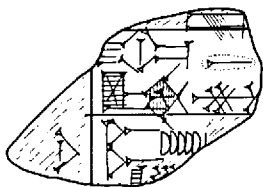

No. 231

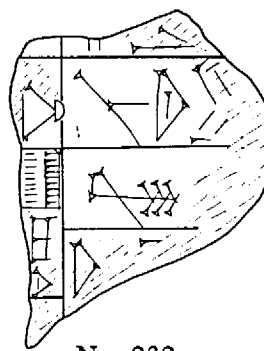

No. 232

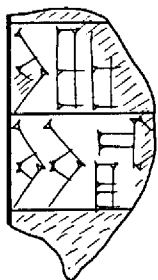

No. 233

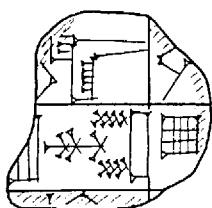

No. 234

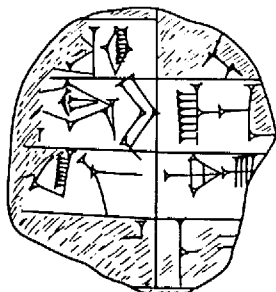

No. 235

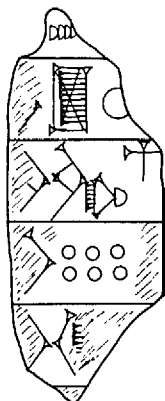

No. 236

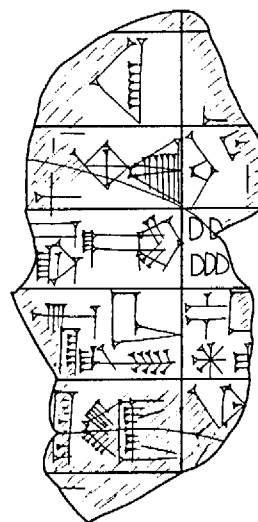

No. 237

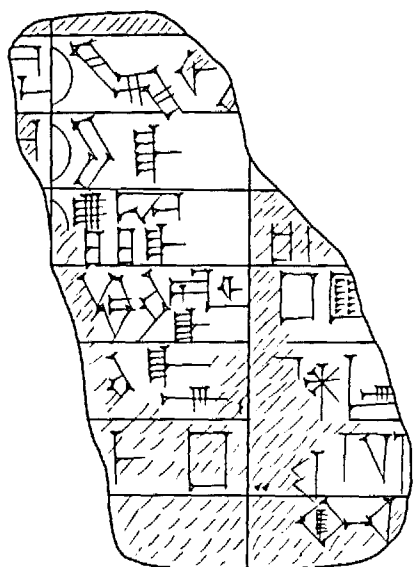

No. 238

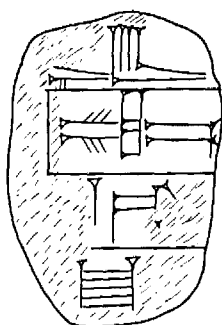

No. 239

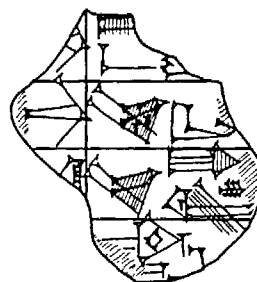

No. 240

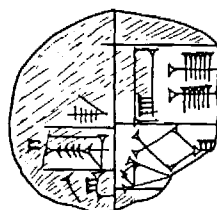

No. 241

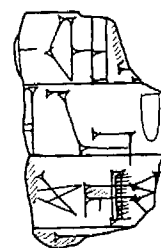

No. 242

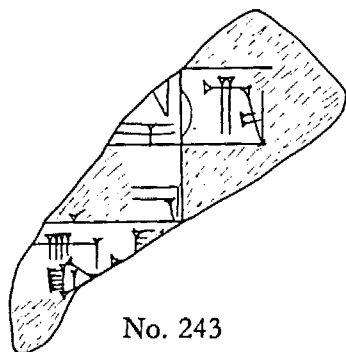

No. 243

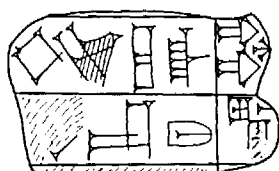

No. 244

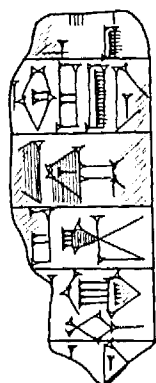

No. 245

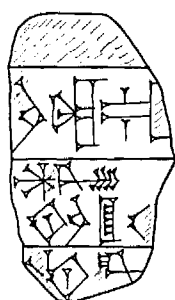

No. 246

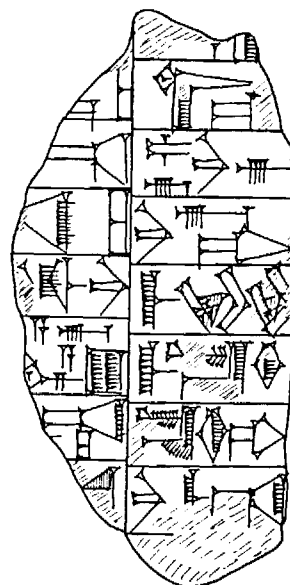

No. 247

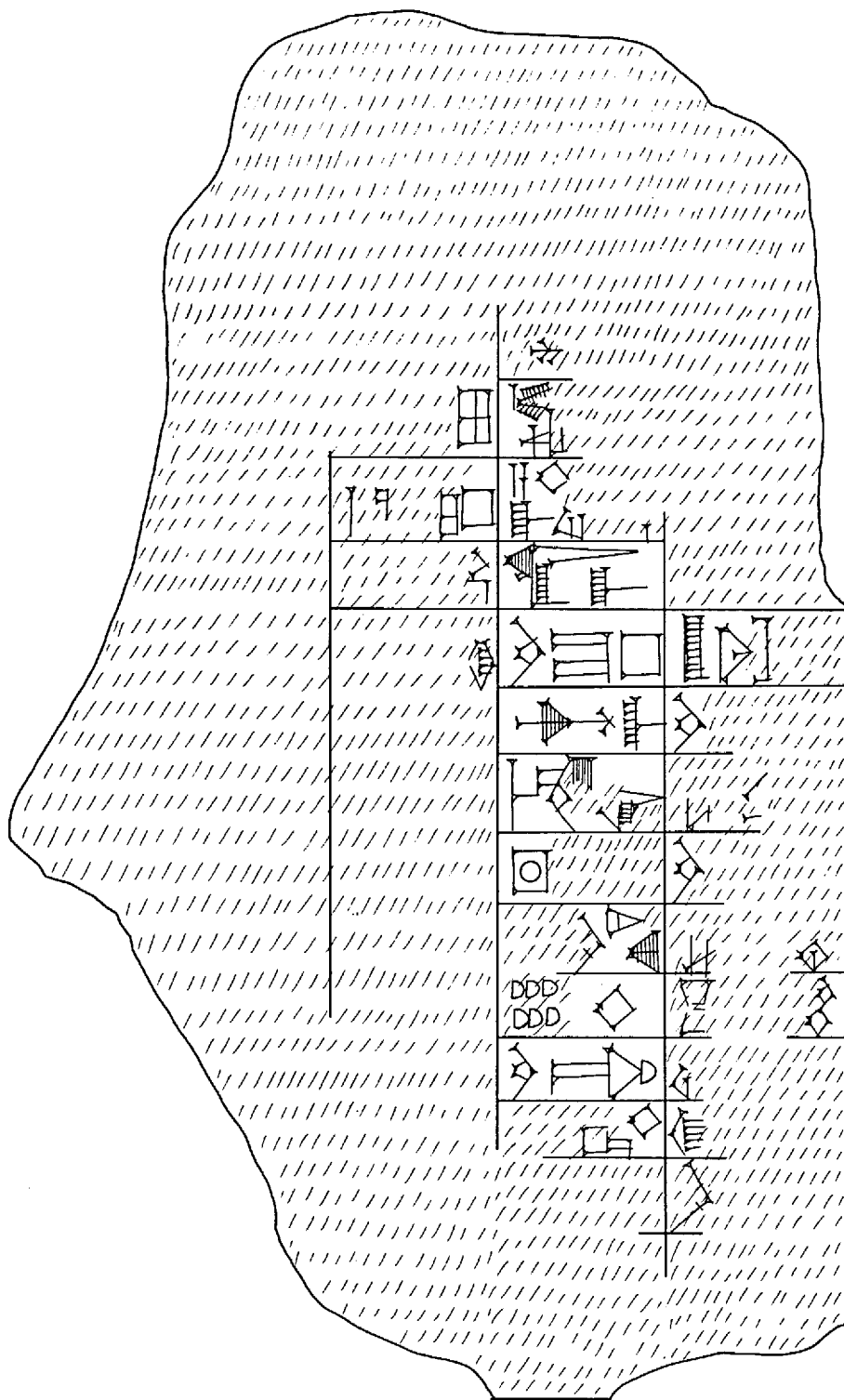

Obverse
No. 248

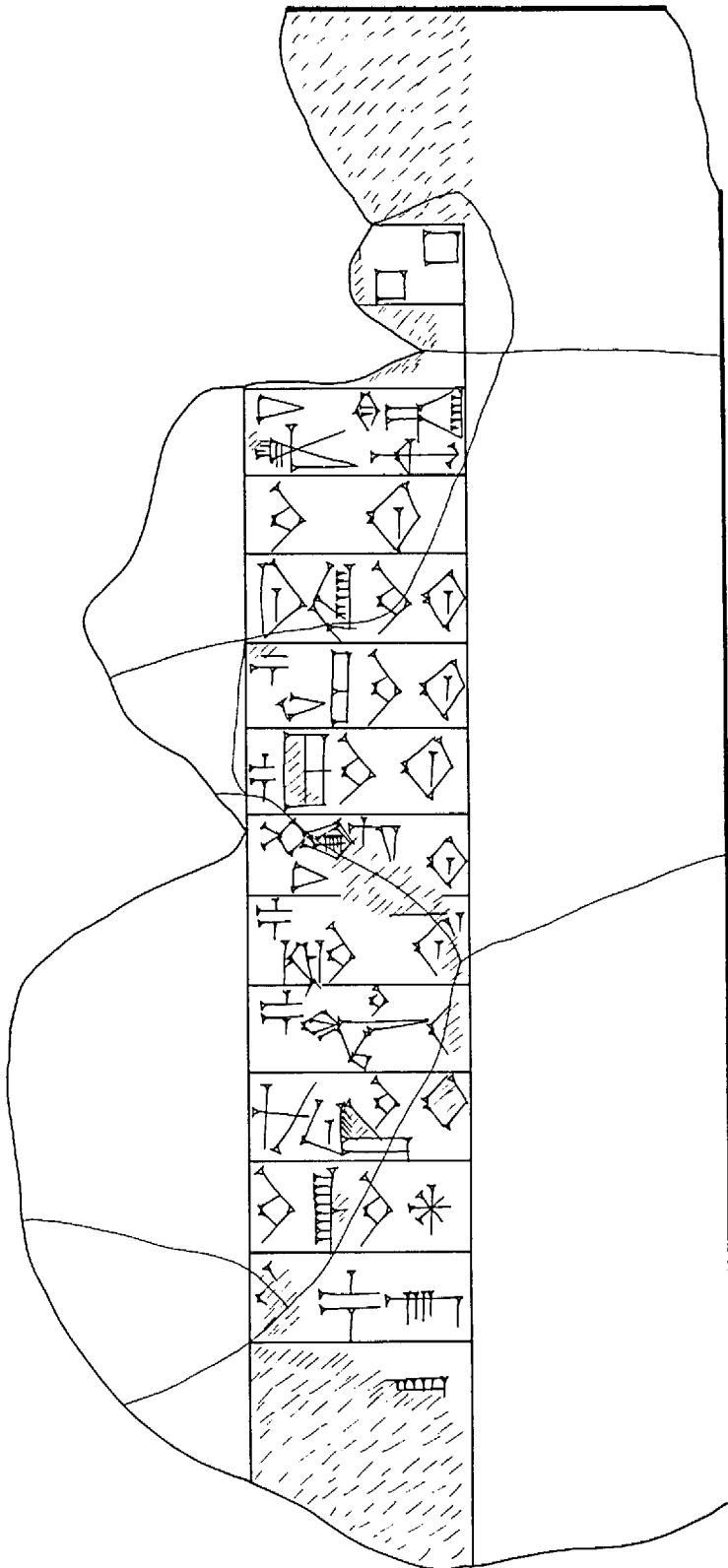

Reverse
No. 248

PLATE 105

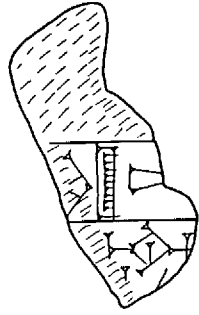

No. 249

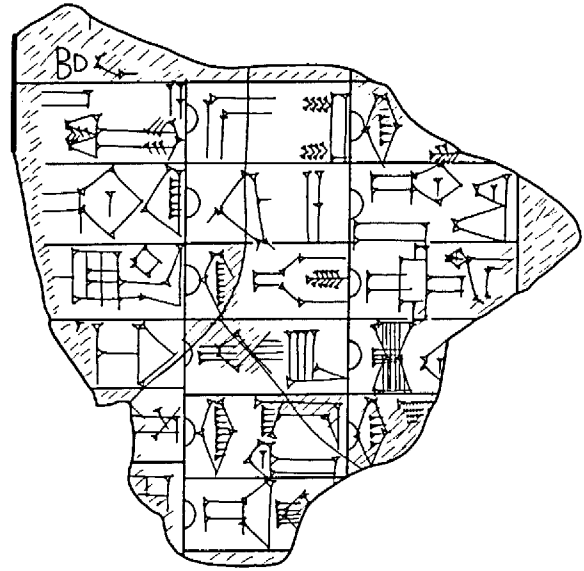

No. 250

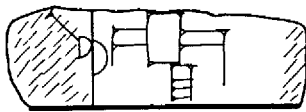

No. 251

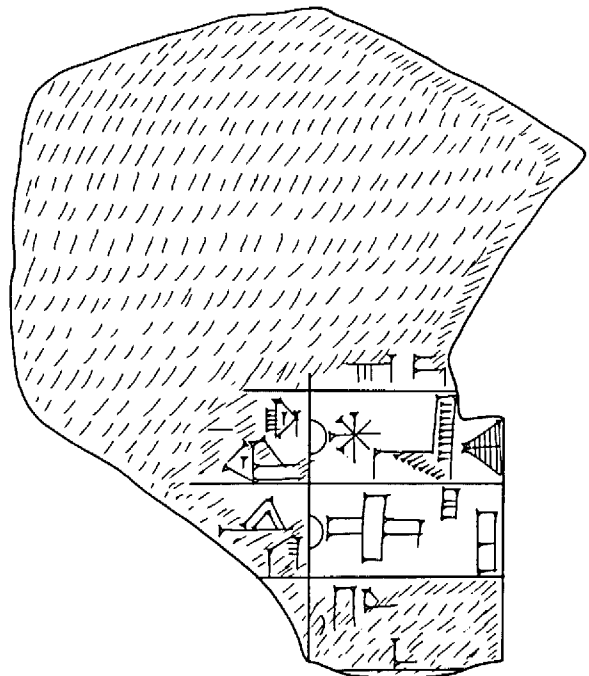

No. 252

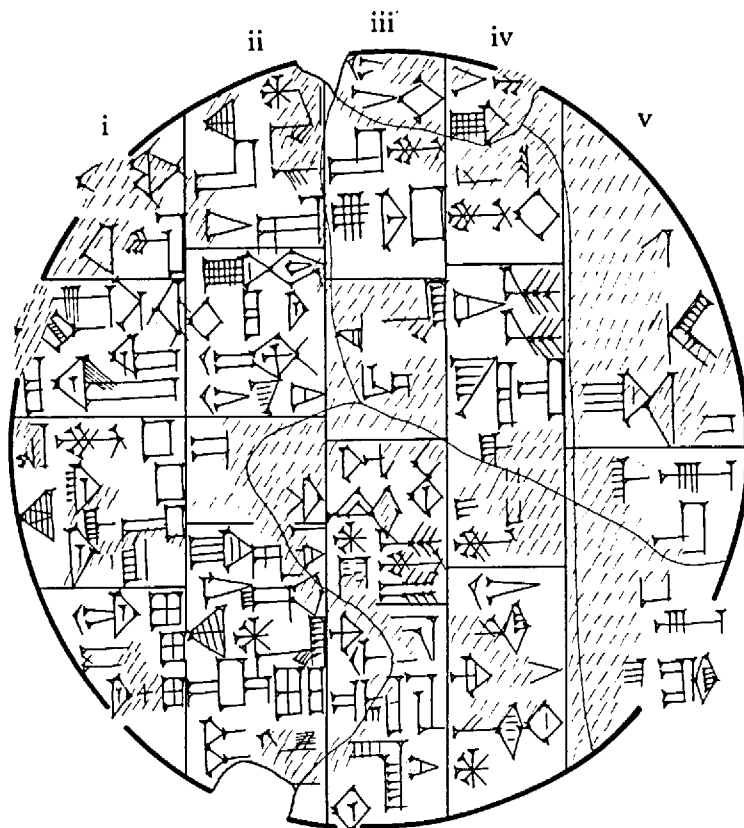

Obverse
No. 253

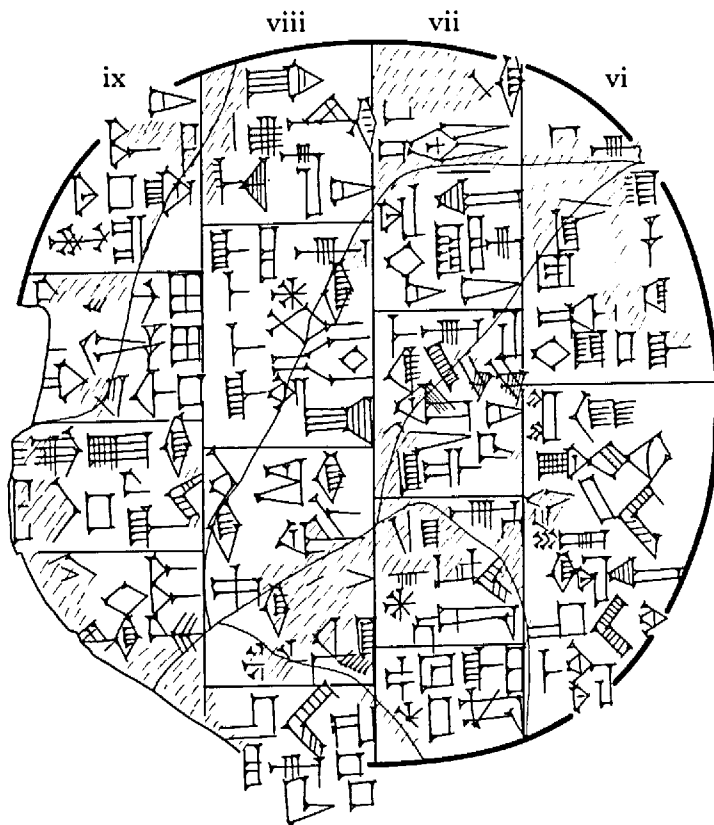

Reverse
No. 253

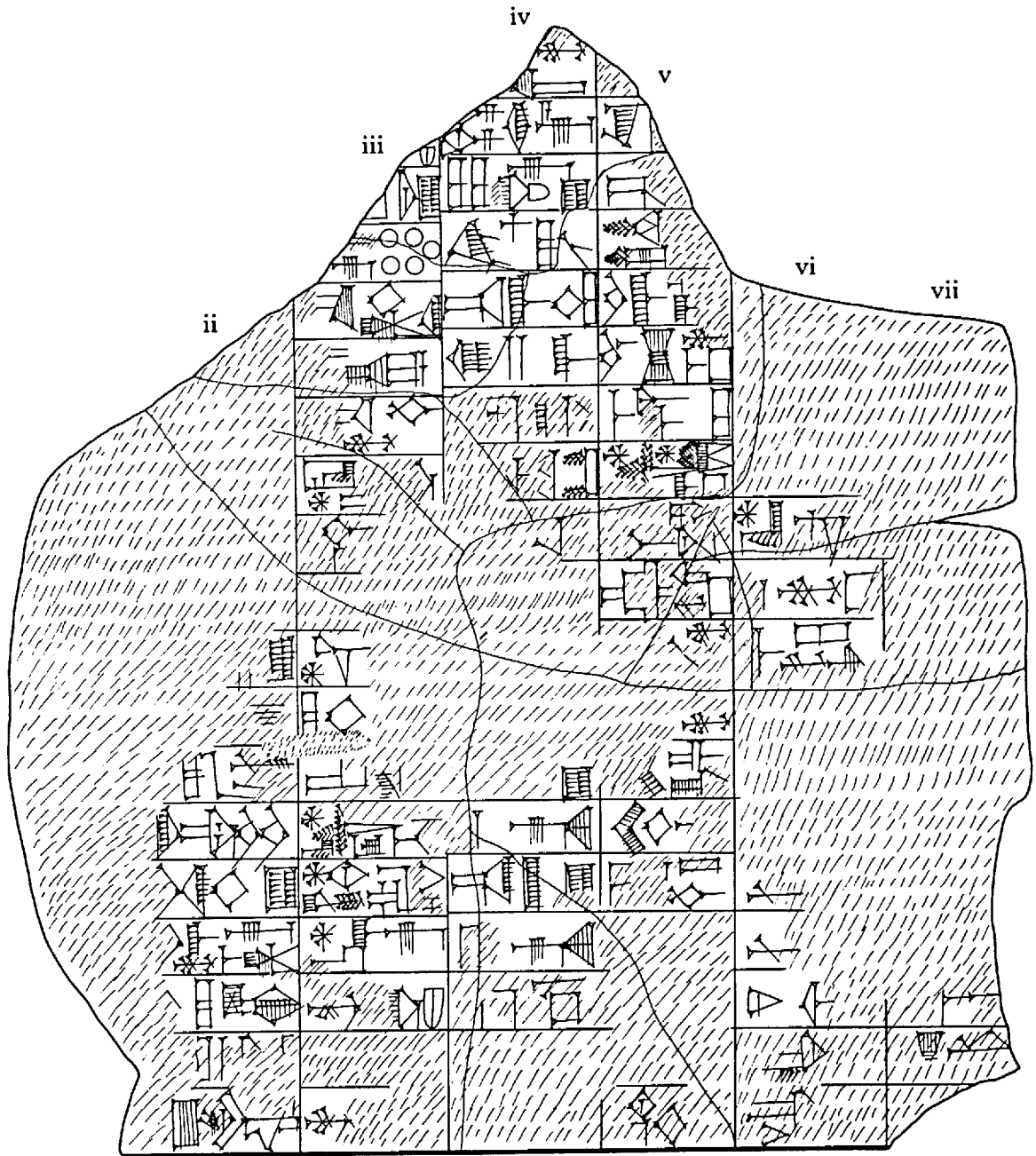

Obverse
No. 254

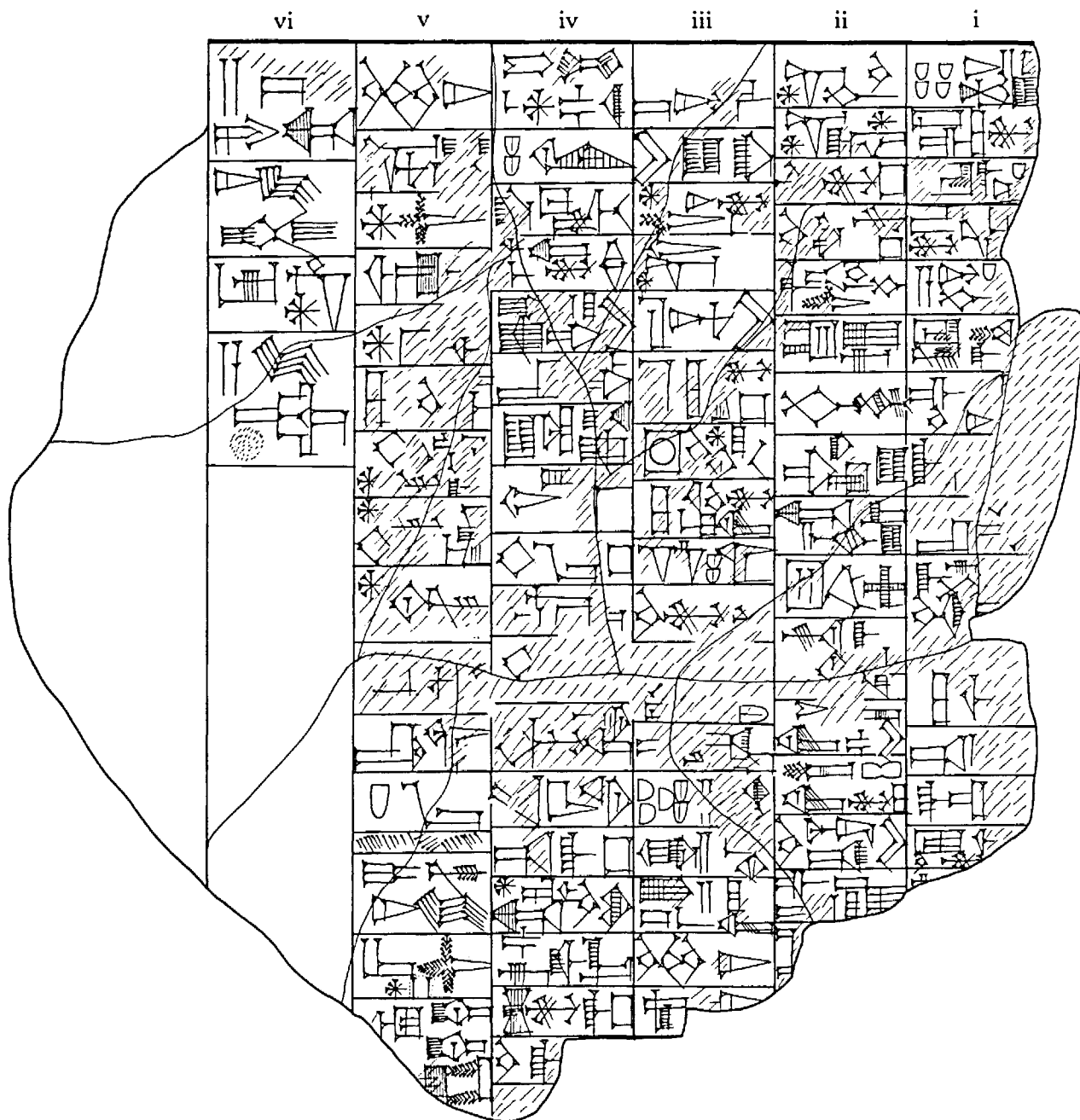

Reverse
No. 254

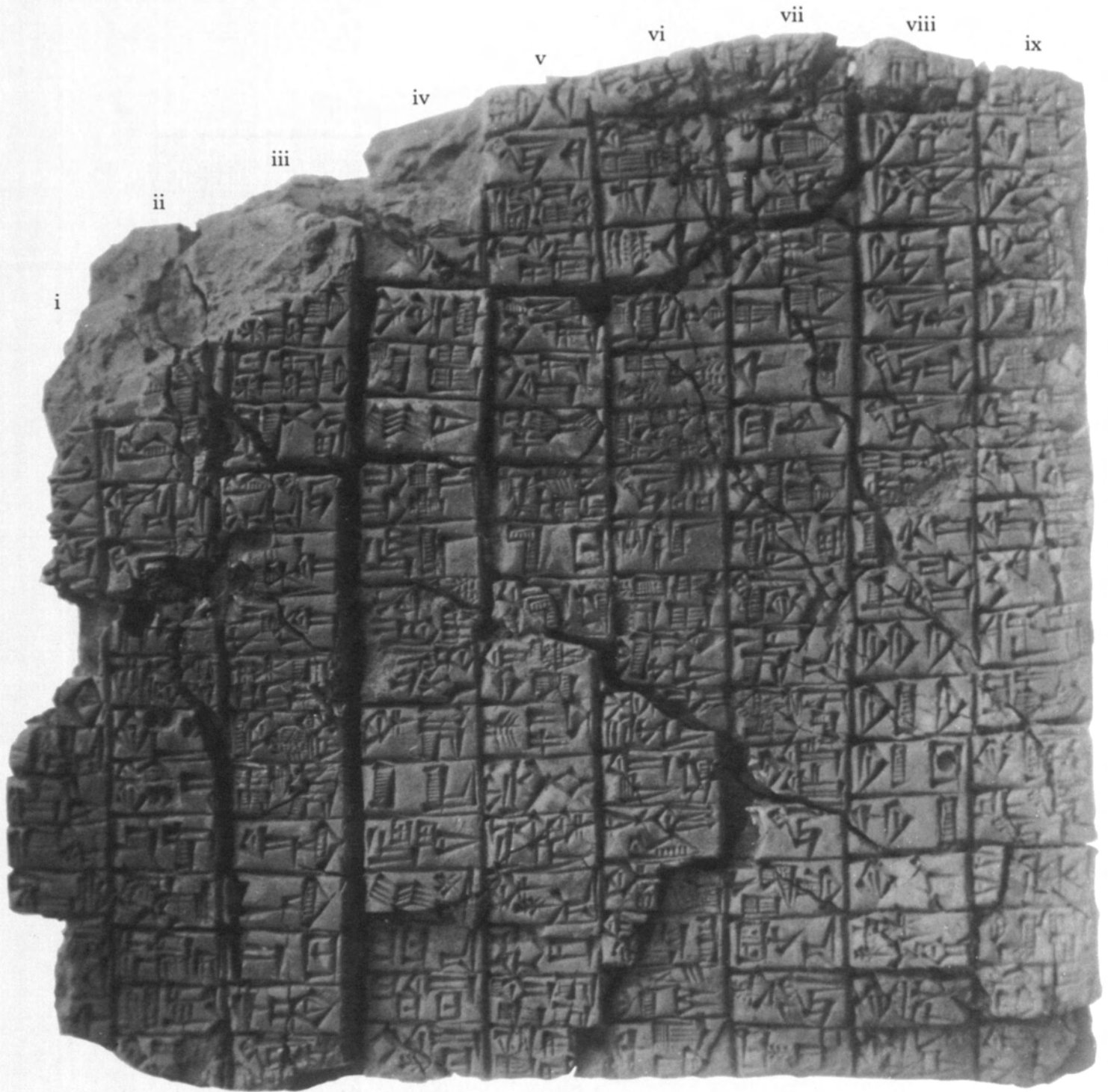

Obverse
No. 255

x



Reverse
No. 255

PLATE 111

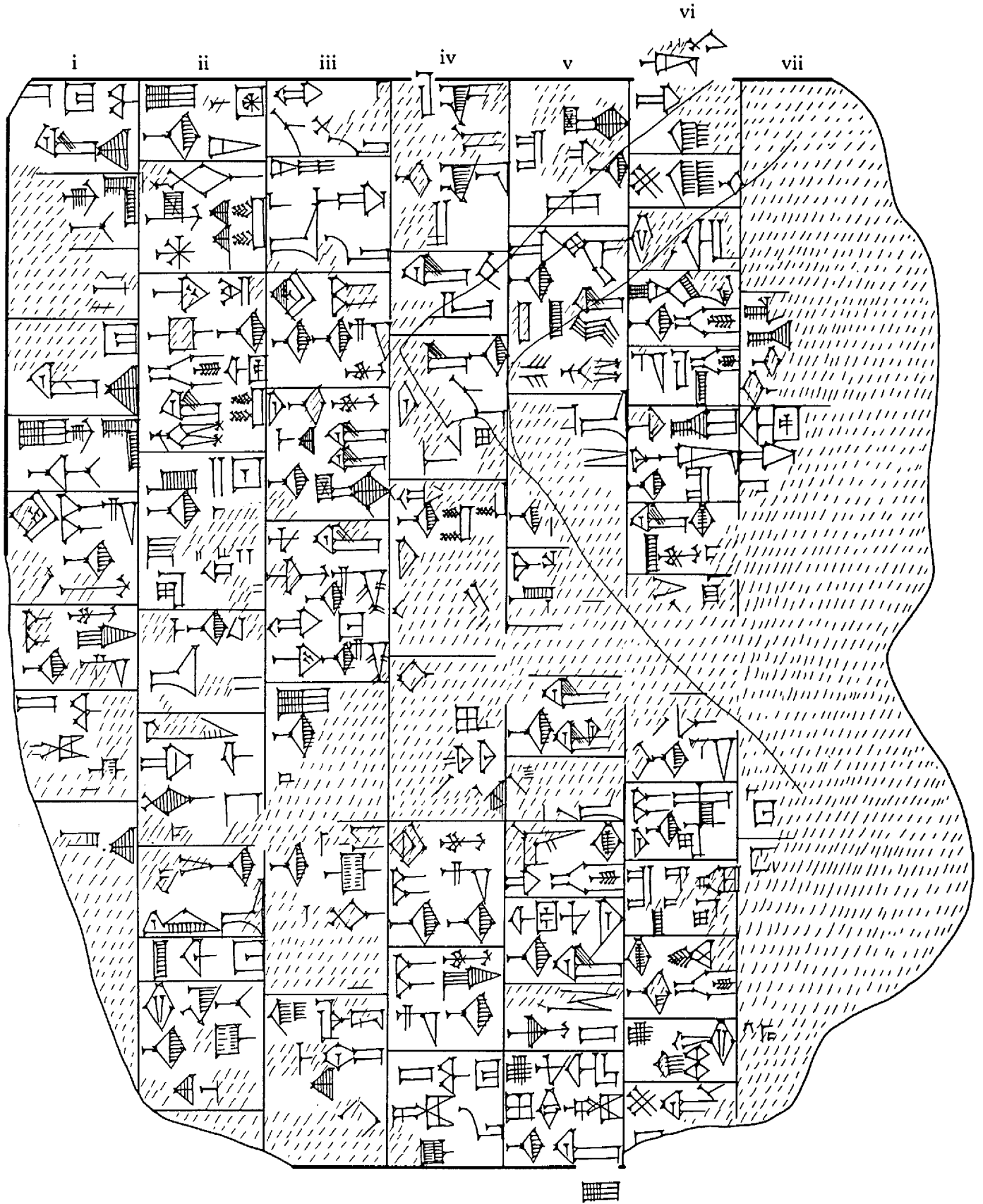

Obverse
No. 256

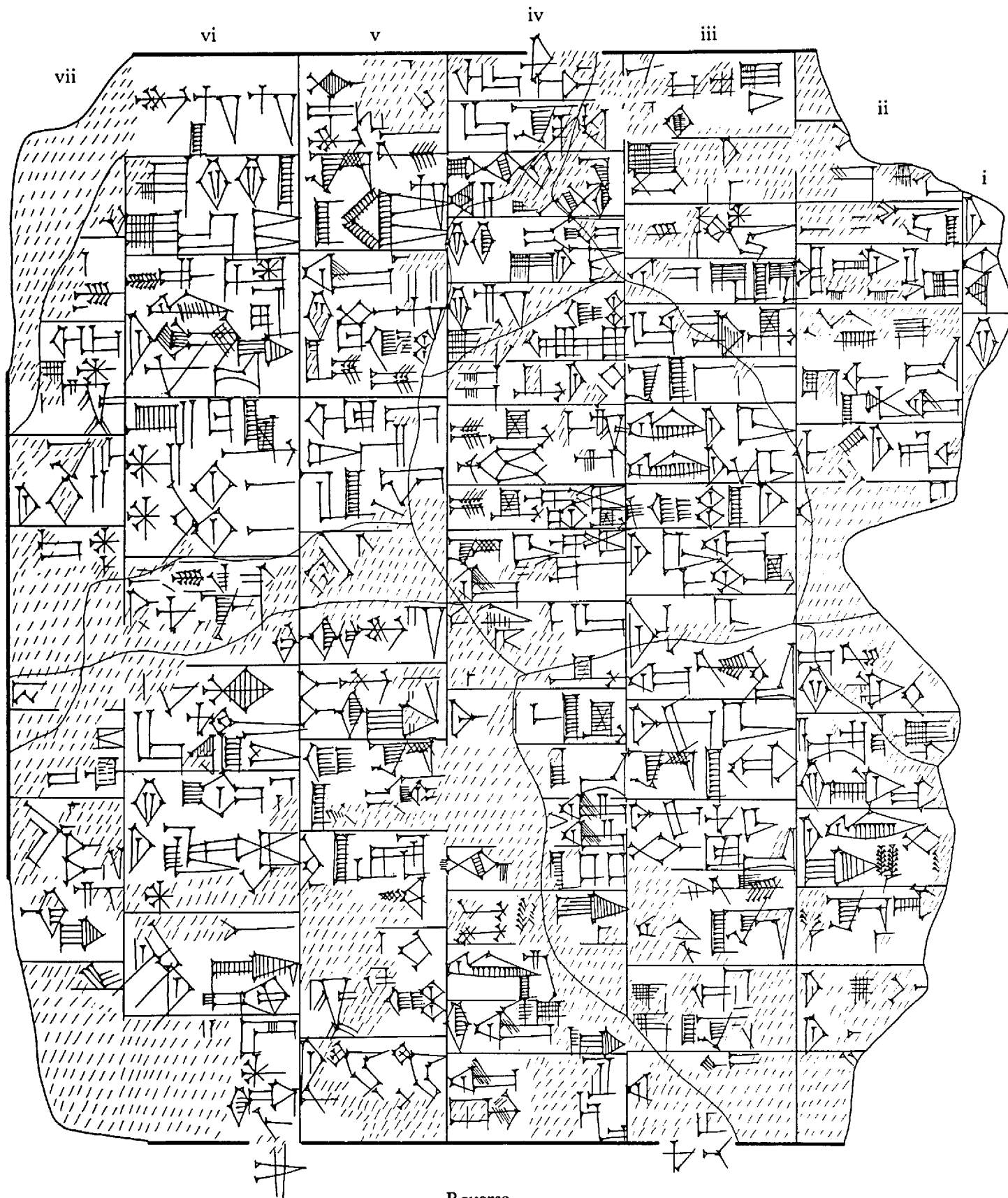

Reverse
No. 256

i ii iii iv v vi vii



Obverse
No. 256



Reverse
No. 256

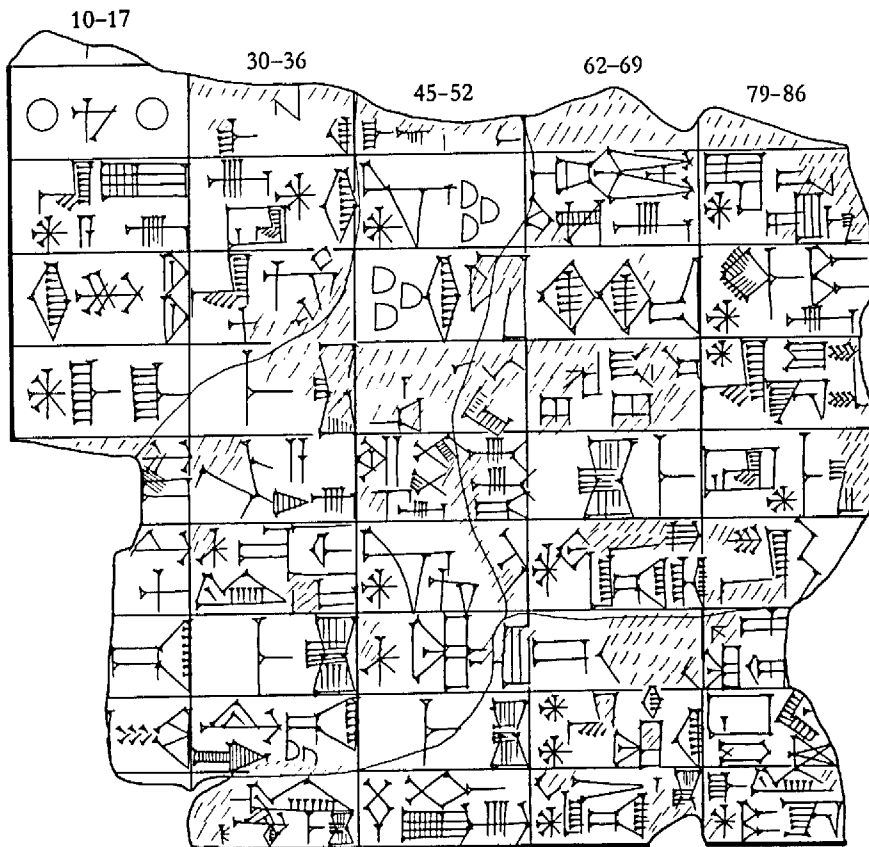
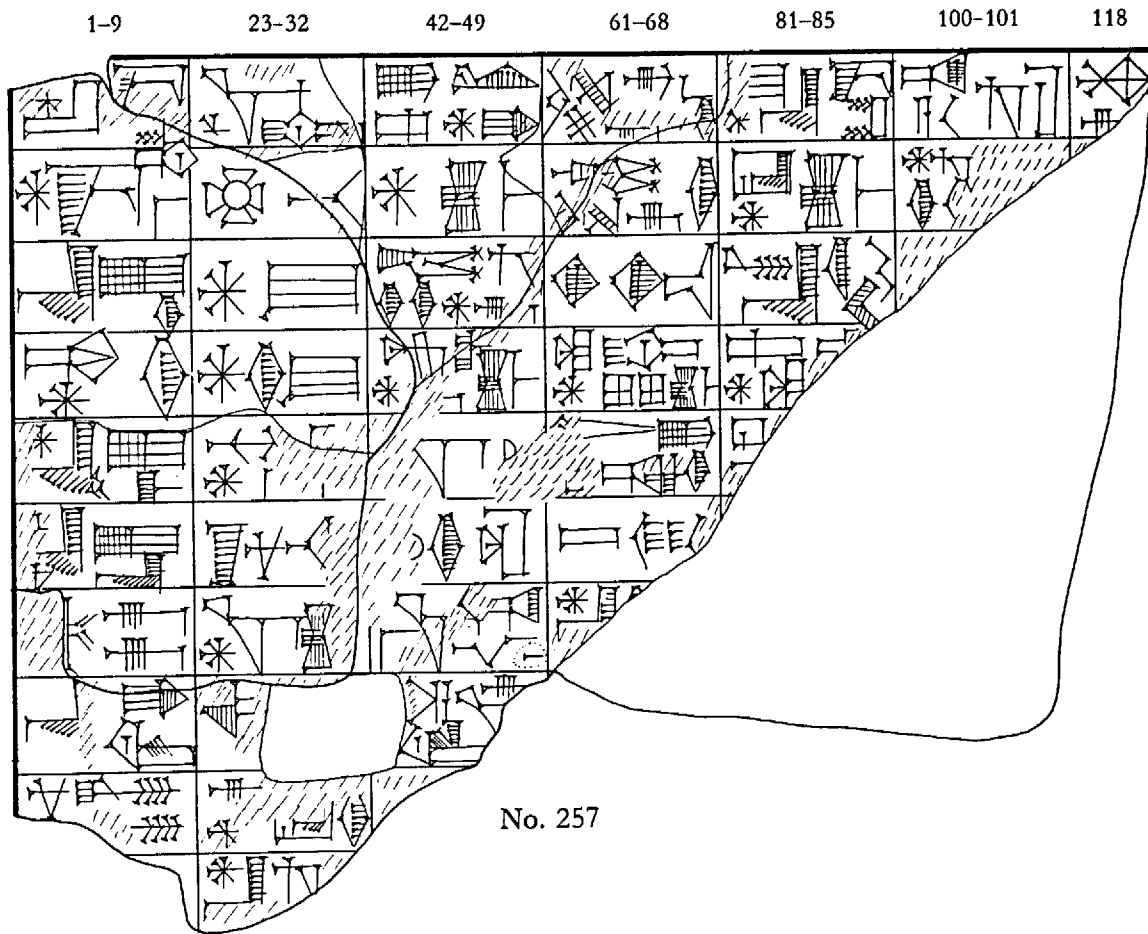

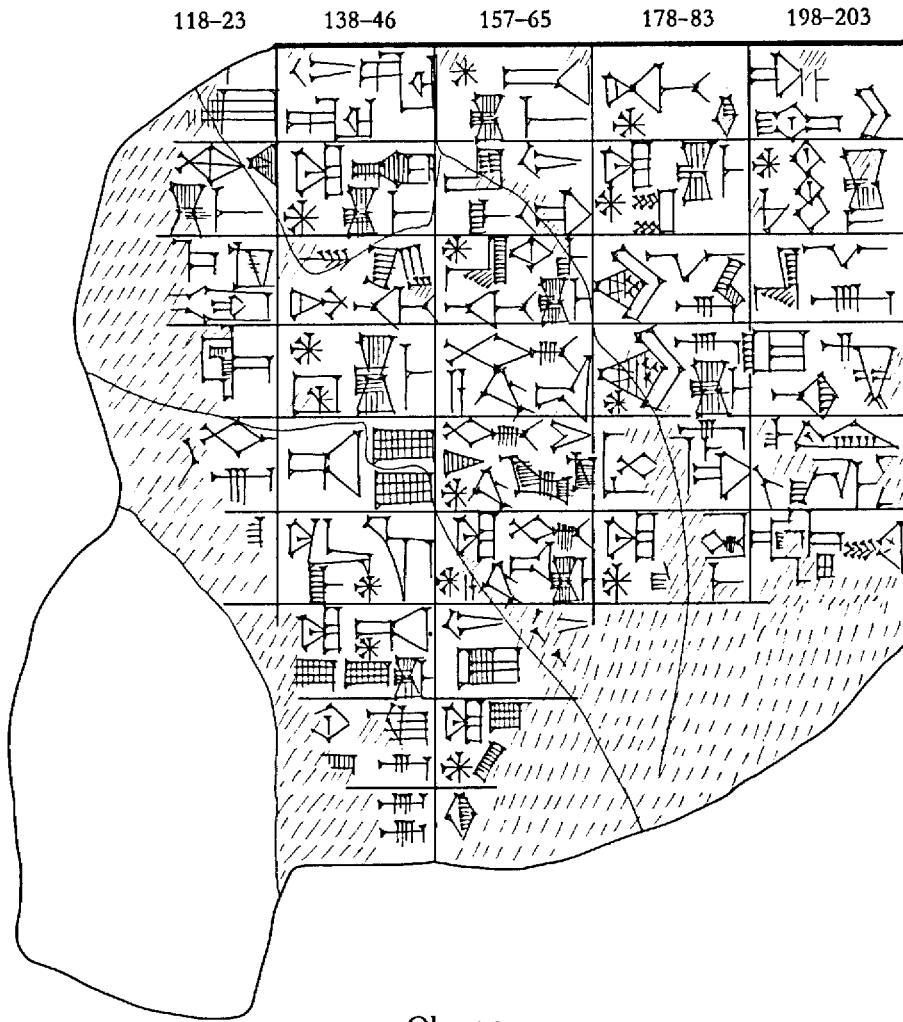

Obverse
No. 259

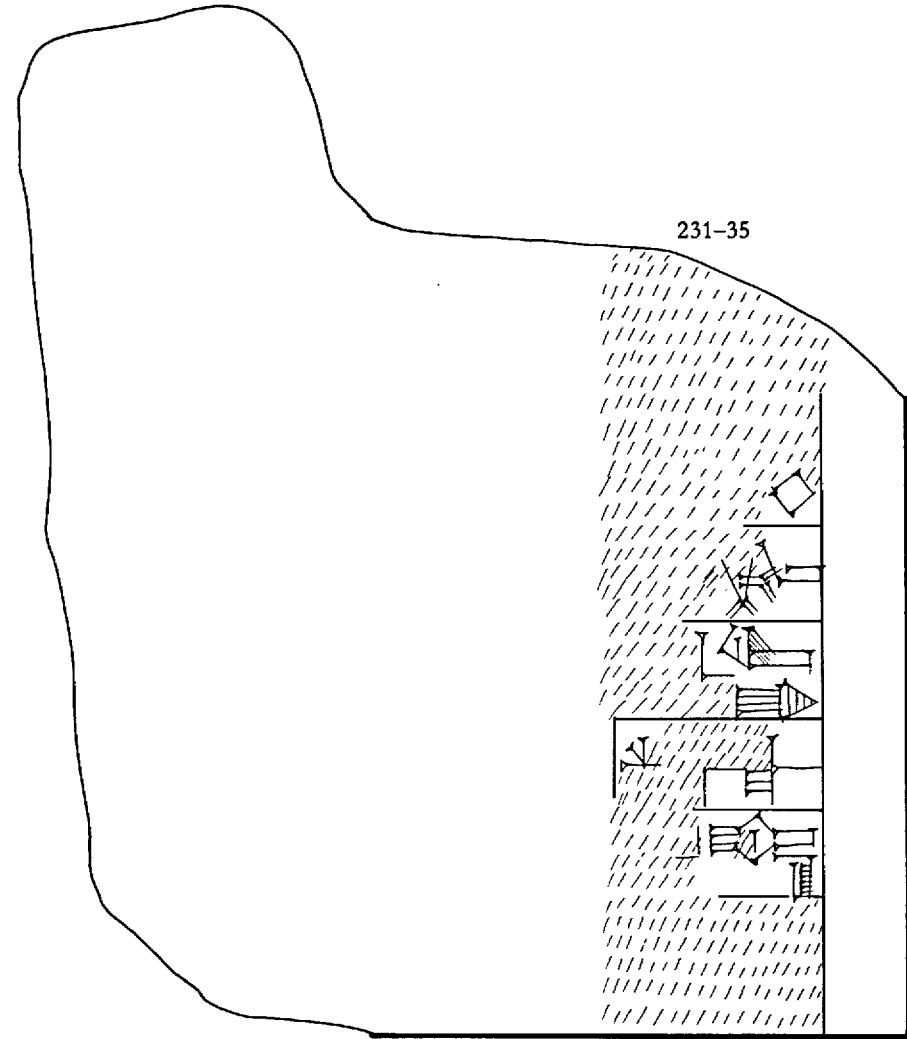

Reverse
No. 259

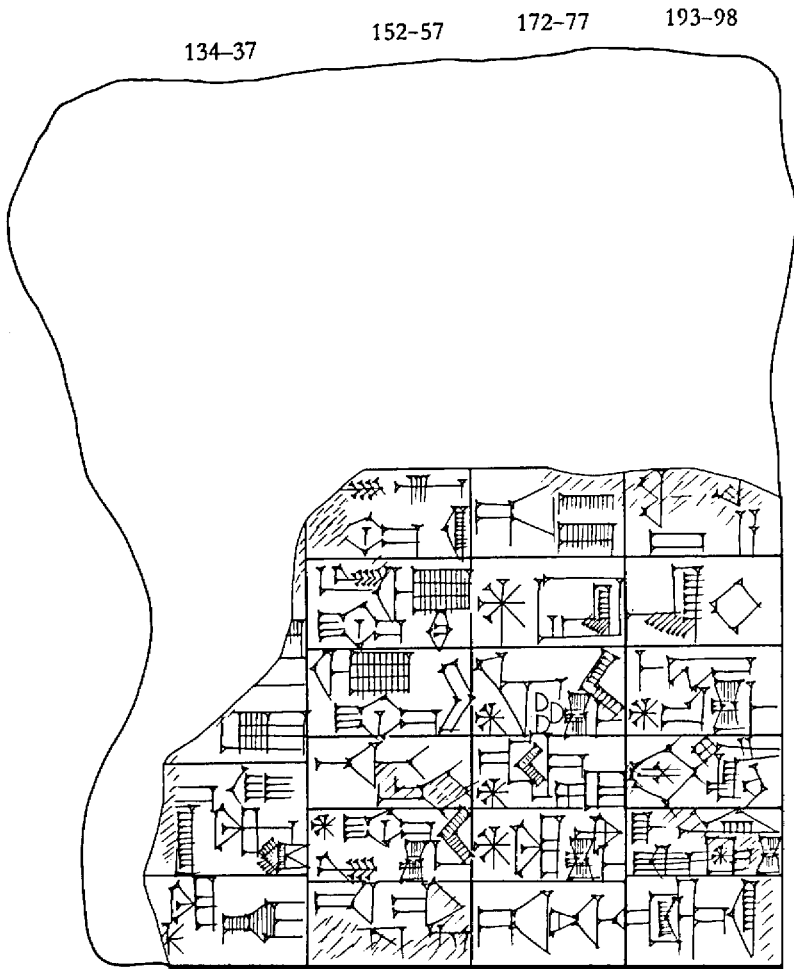
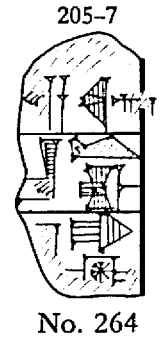
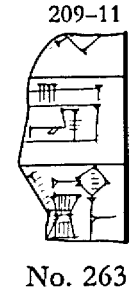
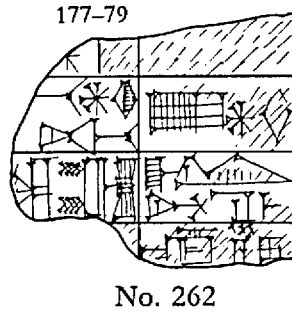
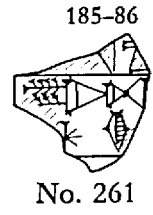
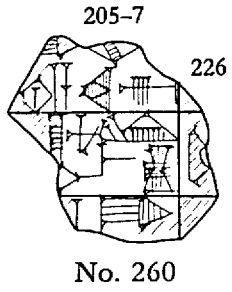

Obverse
No. 265

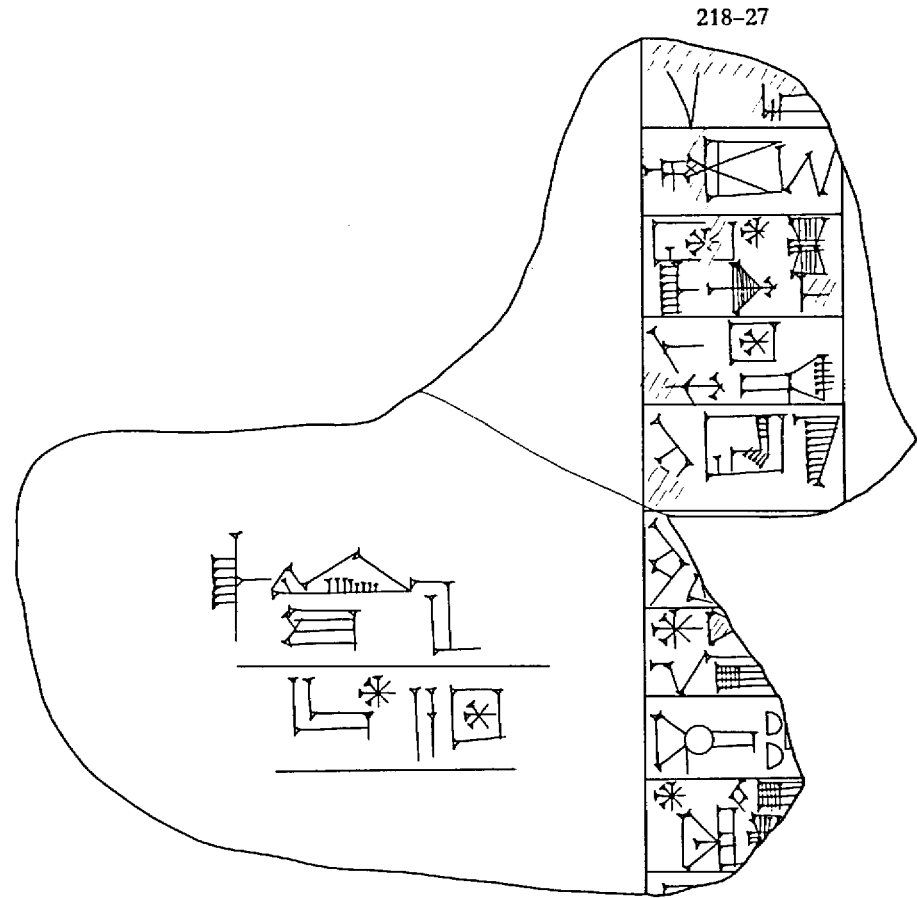

Reverse
No. 265

1-21

24-42

43-61

62-79

81-94

100-106

122-28



Obverse
No. 266

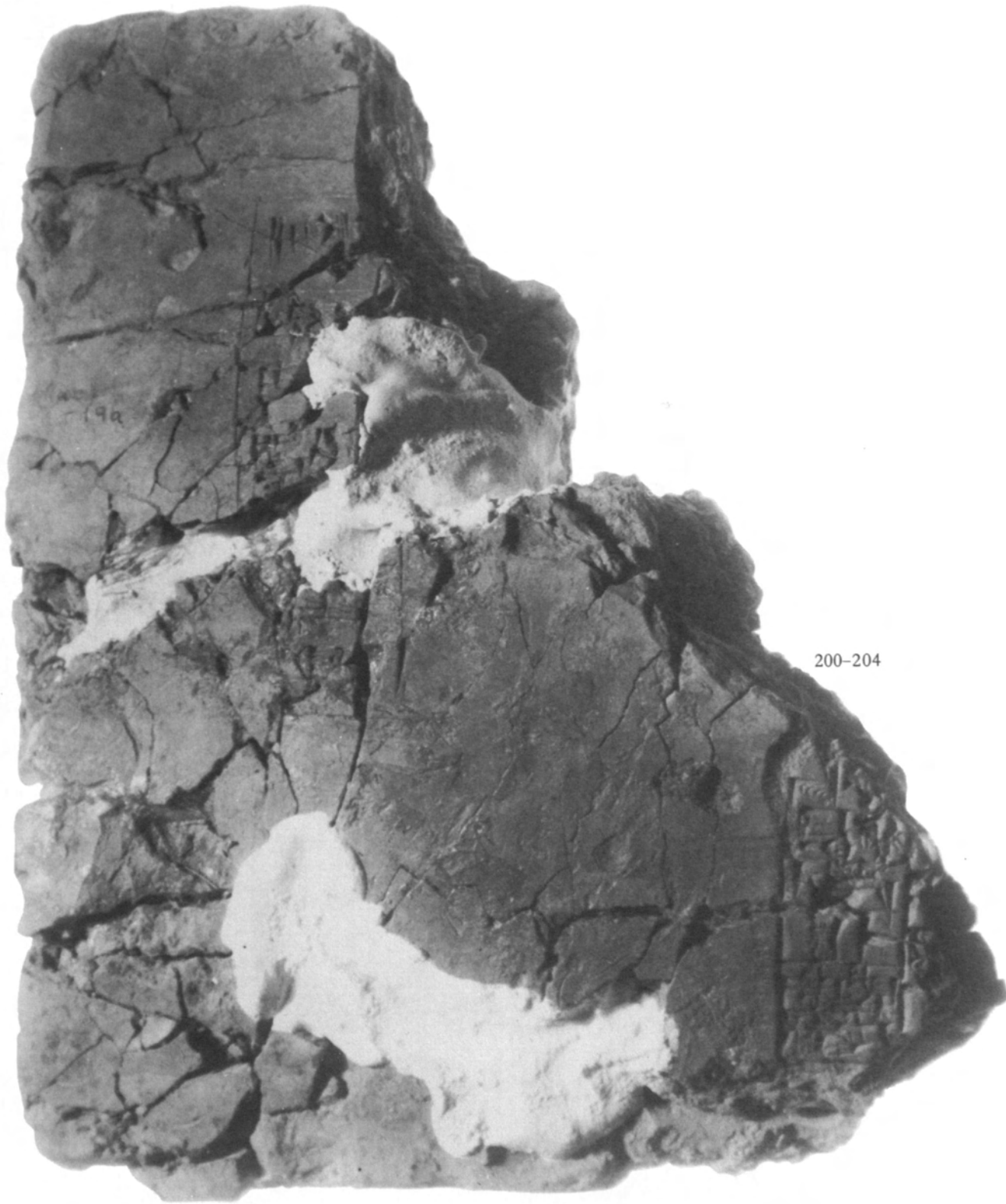

200-204

Reverse
No. 266

PLATE 120



Obverse
No. 267

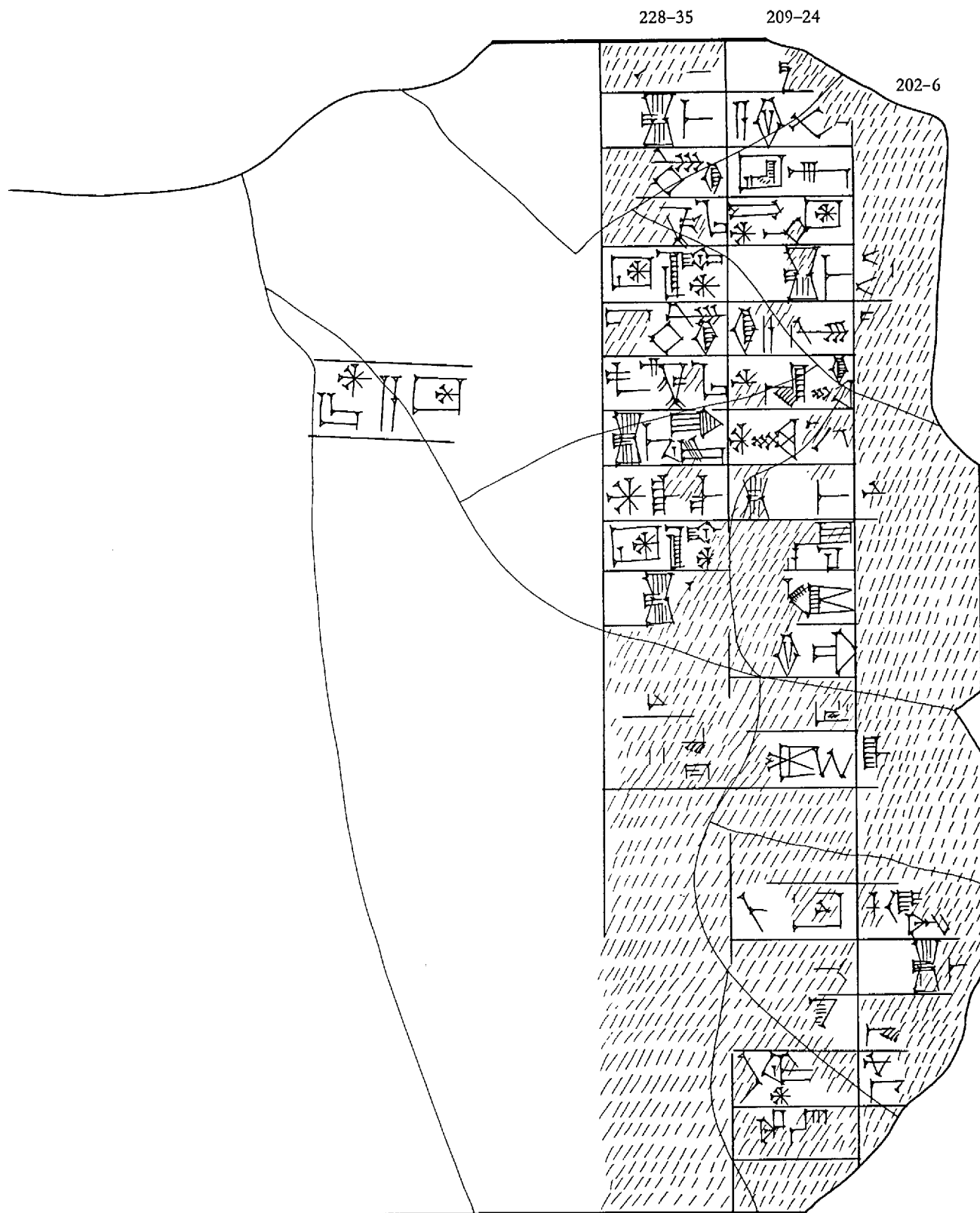

Reverse
No. 267

PLATE 122

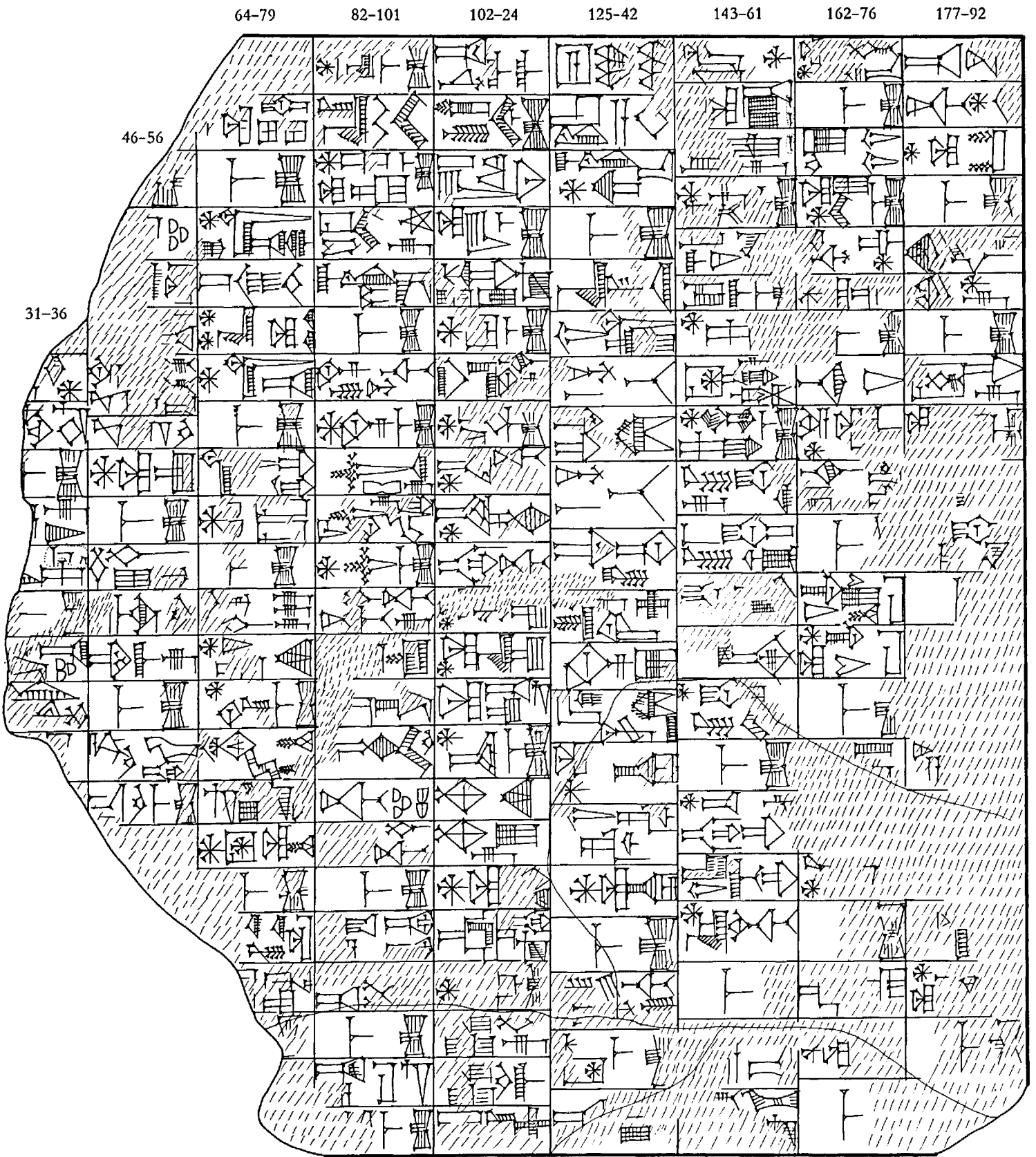

Obverse
No. 268

196-209

210-28

229-35



Reverse
No. 268

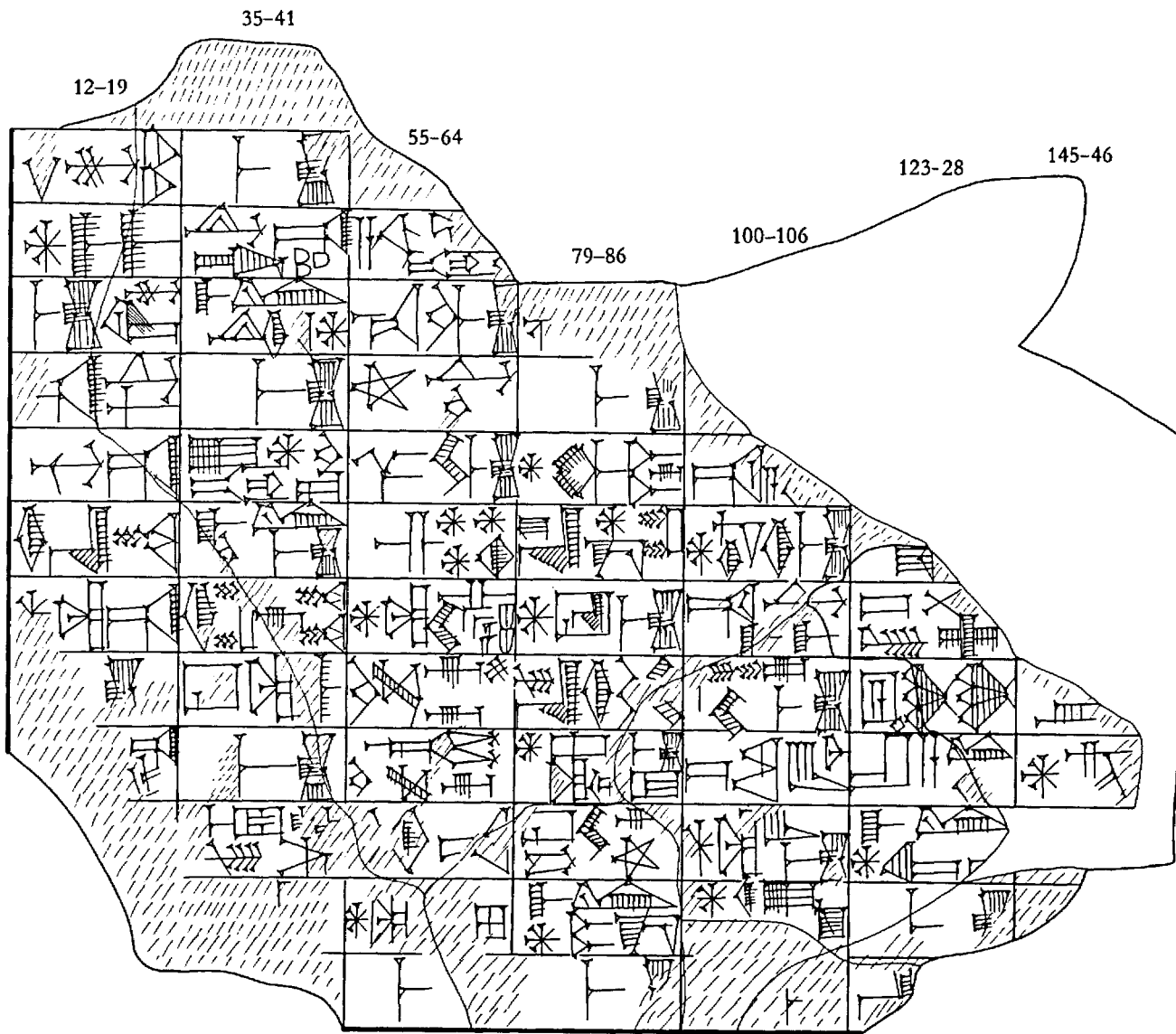

Obverse
No. 269

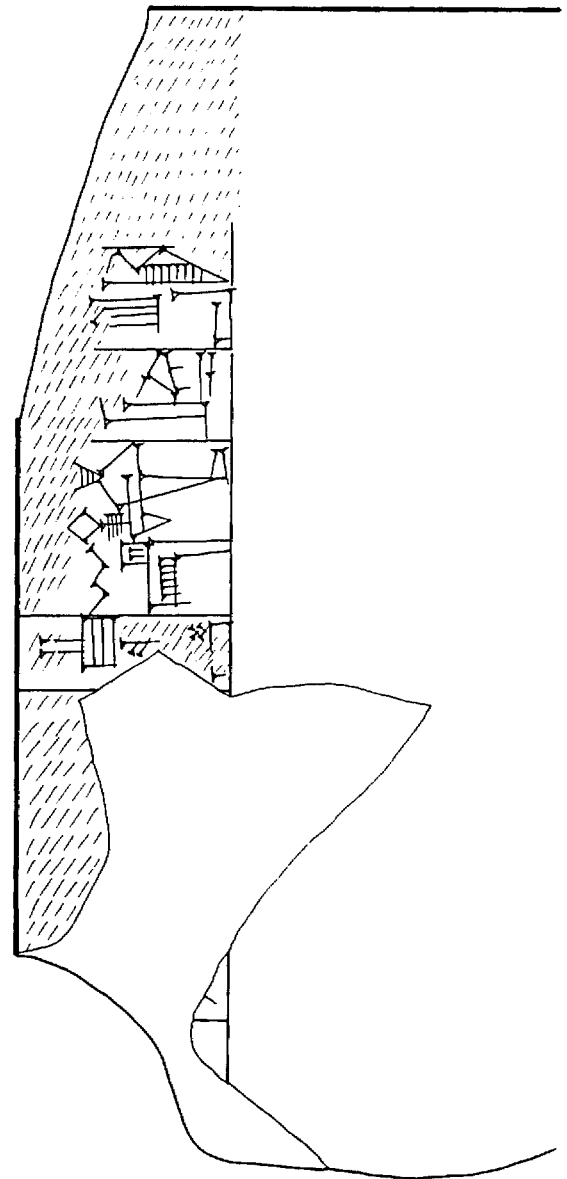

Reverse
No. 269

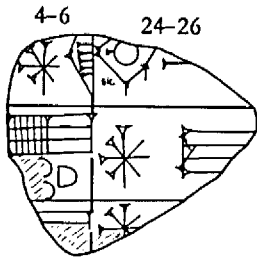

No. 270

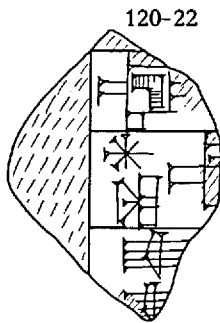

No. 272

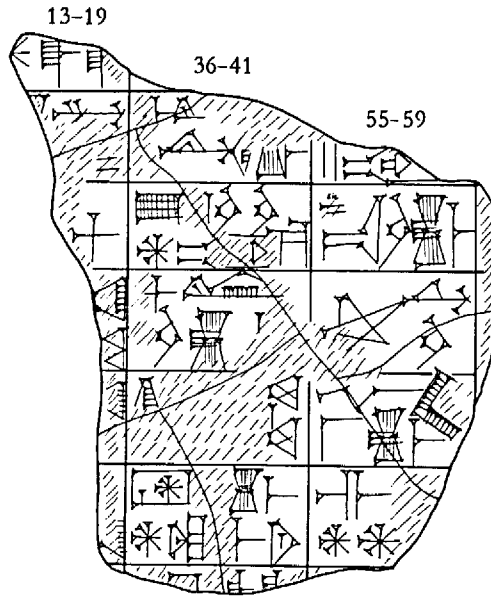

No. 271

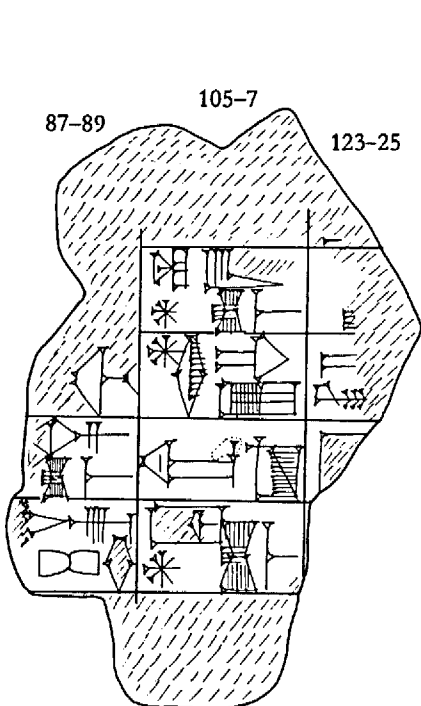

No. 273

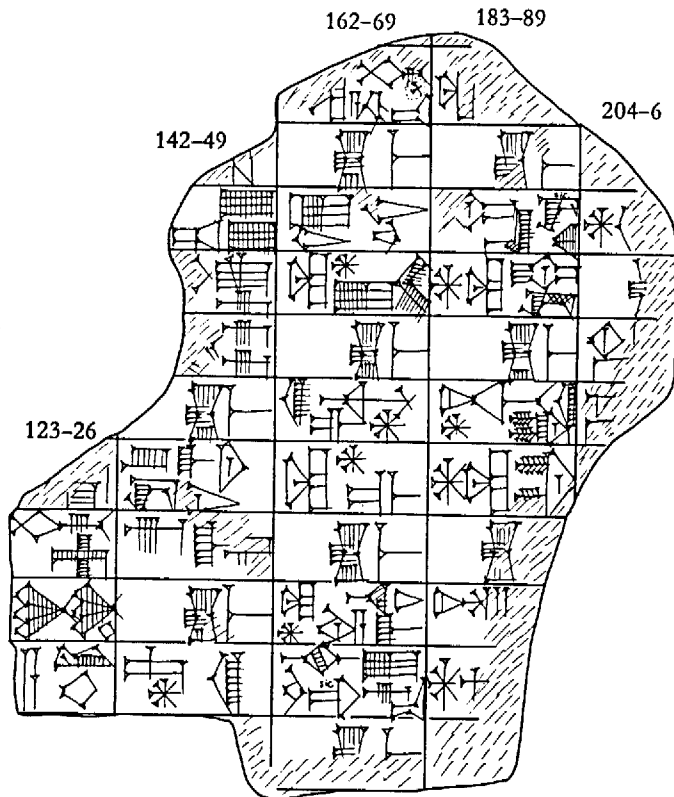

No. 274

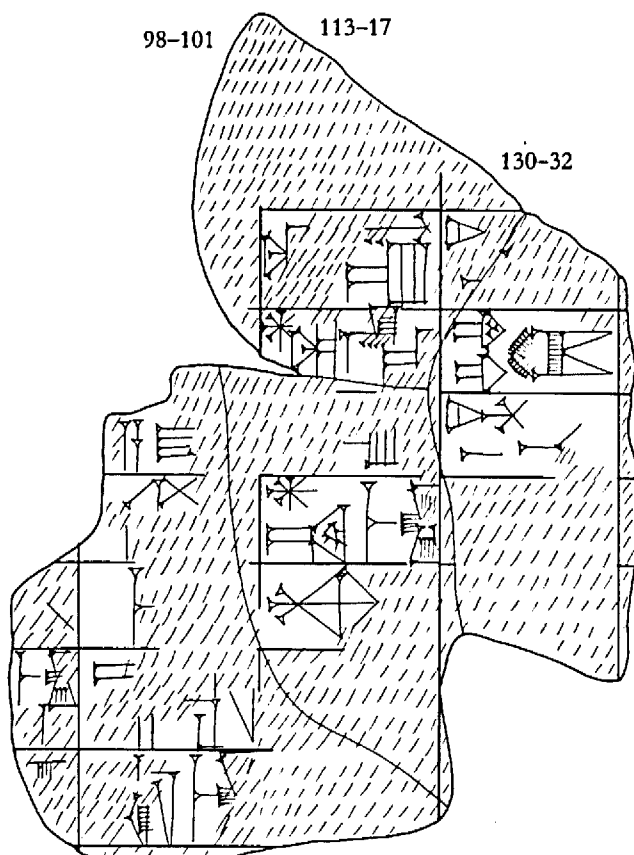

Obverse
No. 275

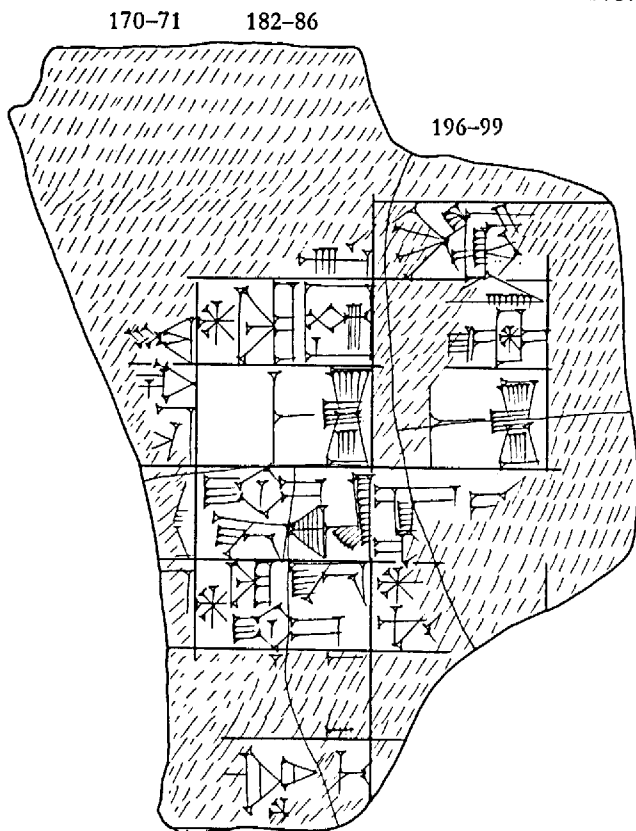

Reverse
No. 275

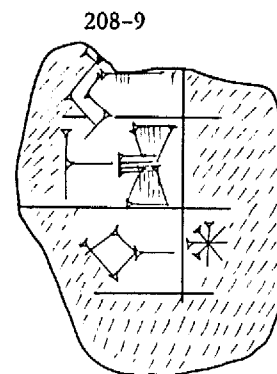

No. 276

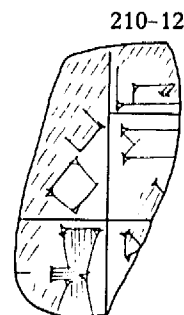

No. 277

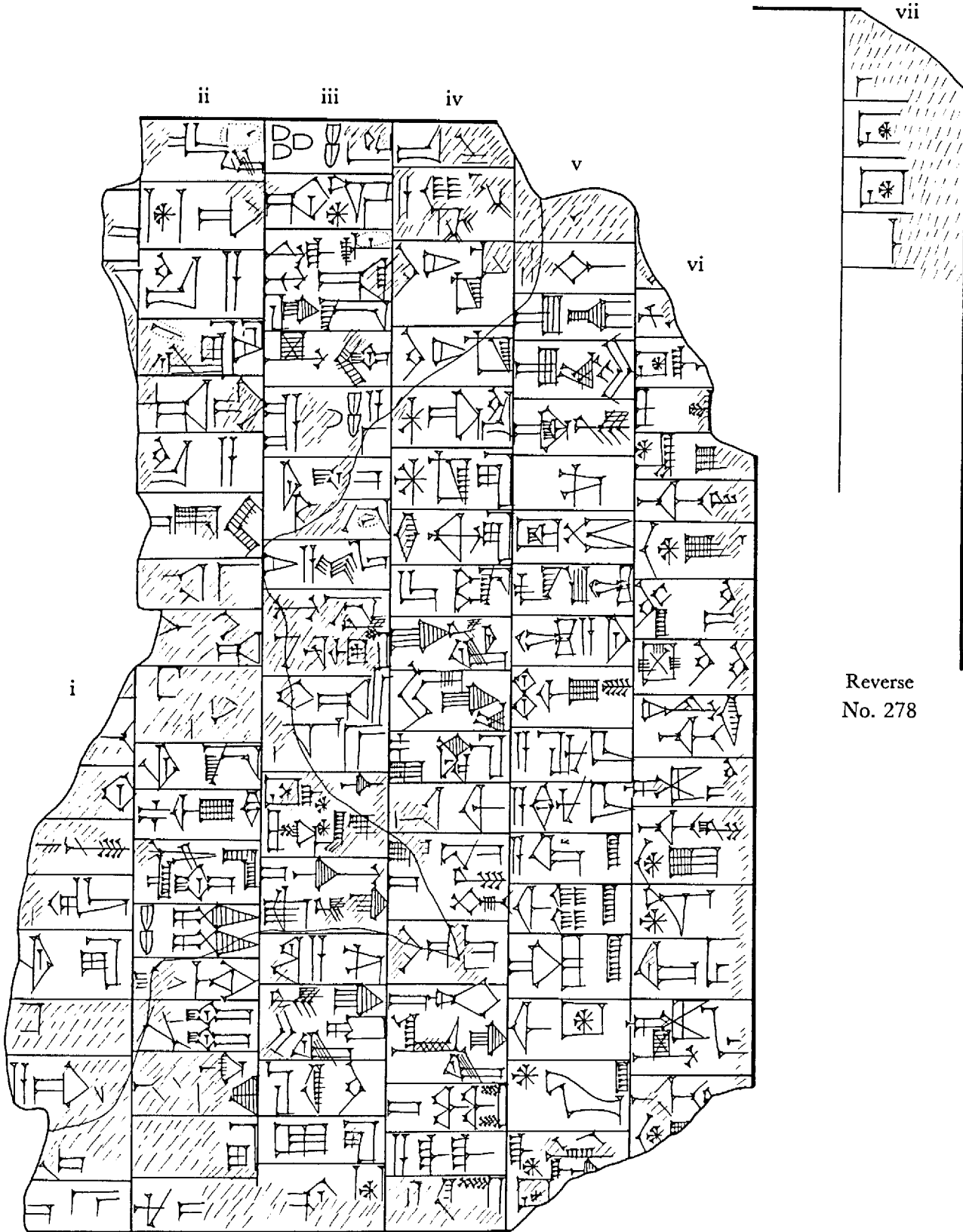

i

ii

iii

iv

v

vi

vii

Reverse
No. 278

Obverse
No. 278

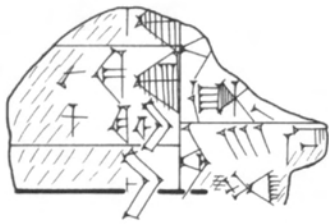

Obverse
No. 279

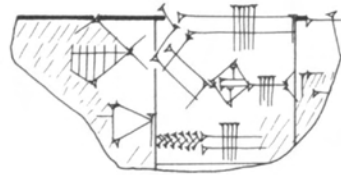

Reverse
No. 279

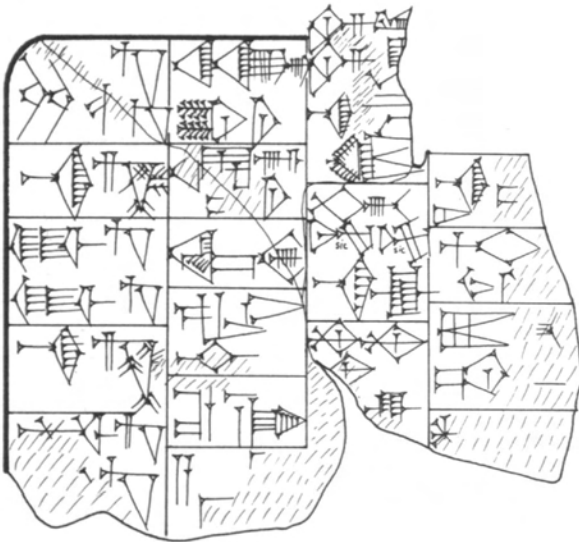

Obverse
No. 280

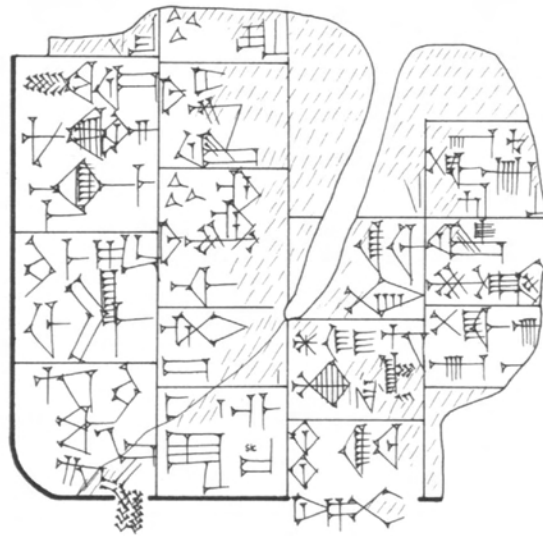

Reverse
No. 280



Obverse
No. 281



Reverse
No. 281

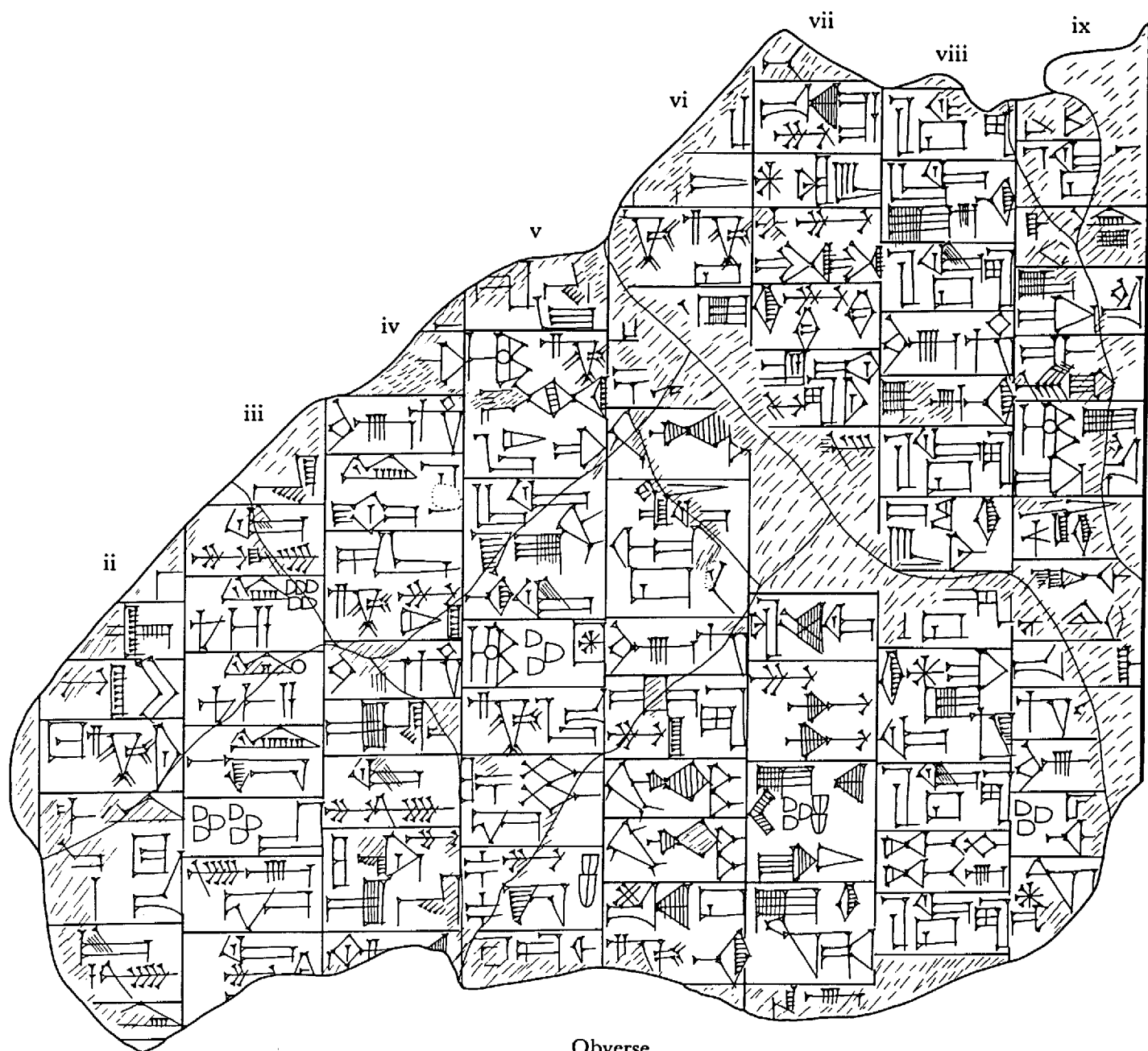

Obverse
No. 282

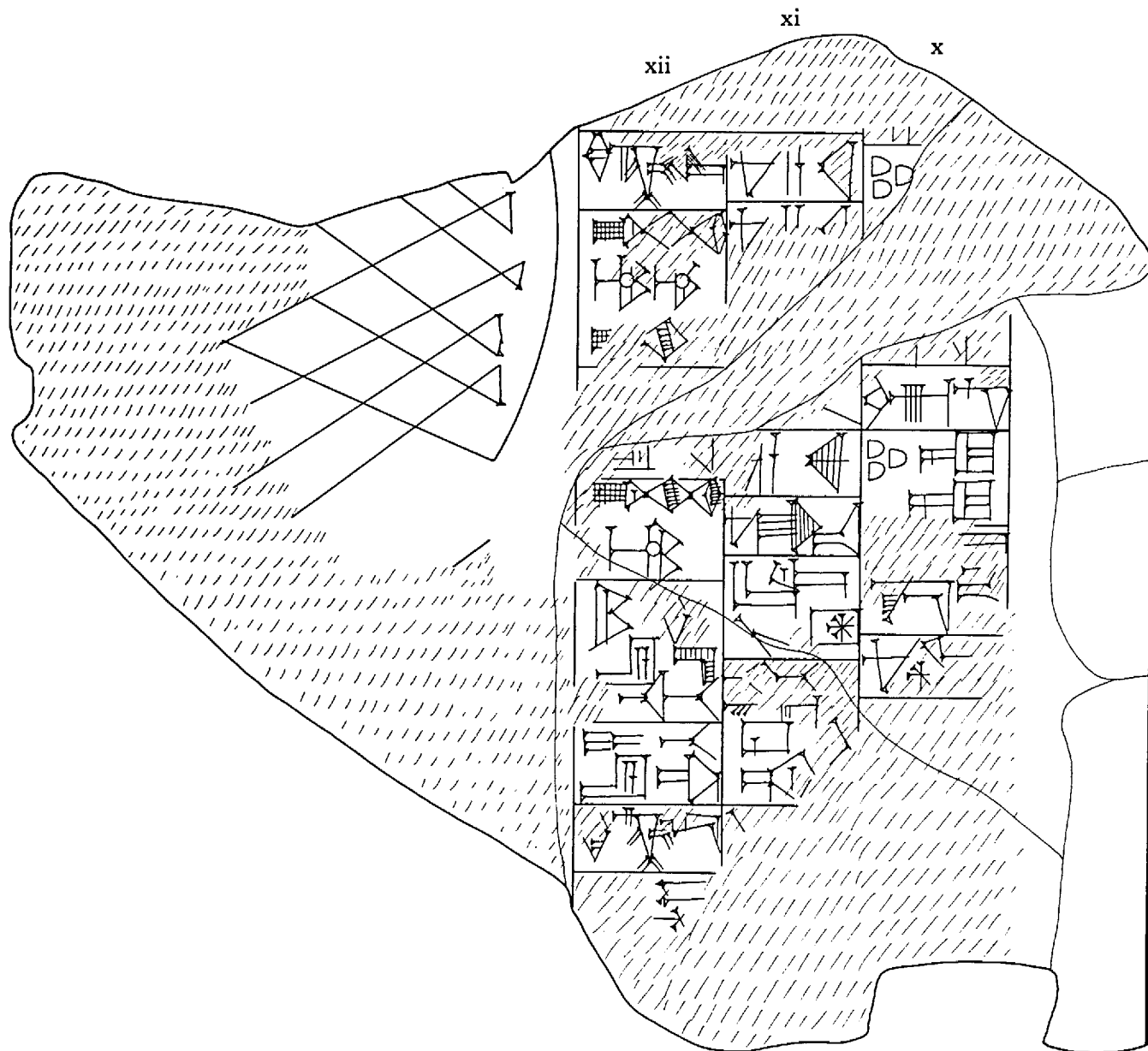

Reverse
No. 282

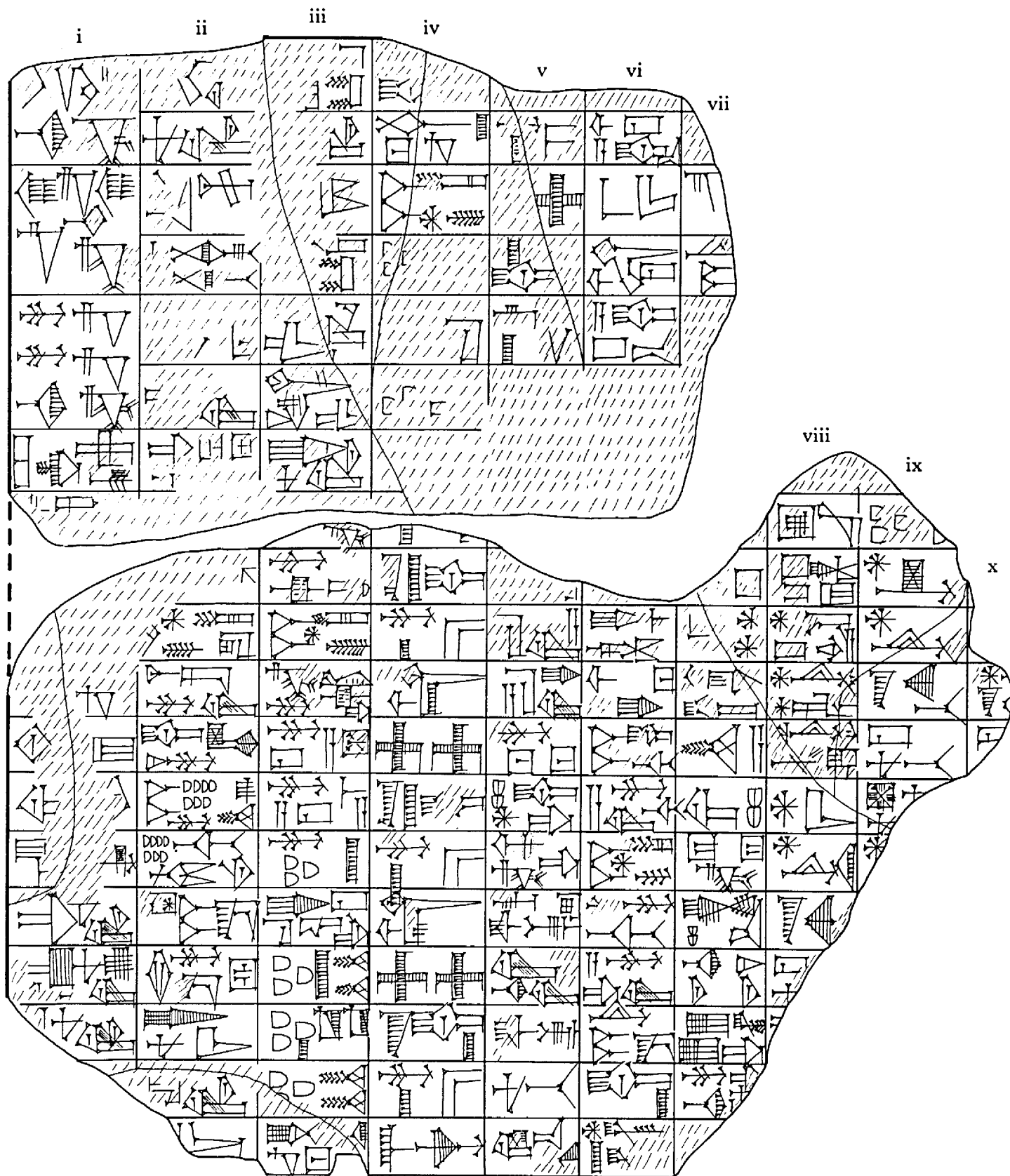

Obverse
No. 283

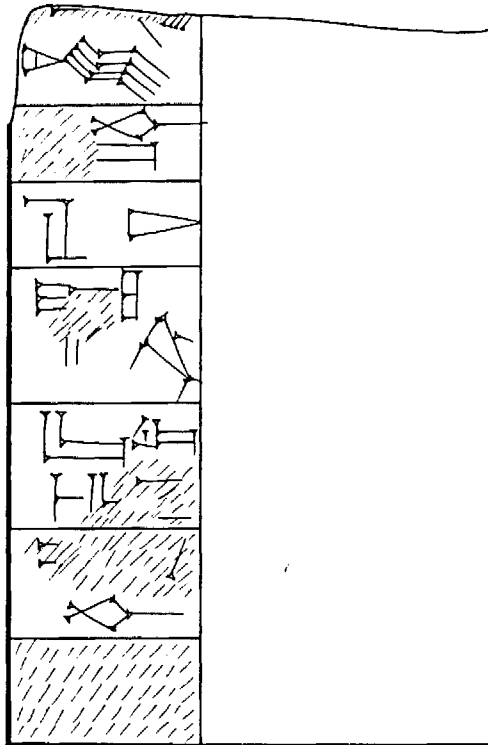
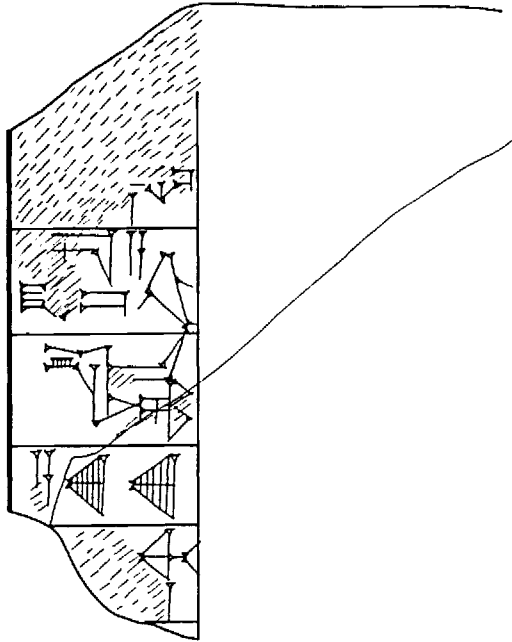

Reverse
No. 283



No. 284

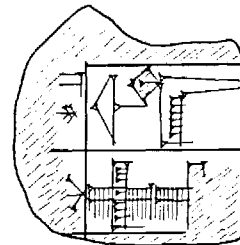

No. 285

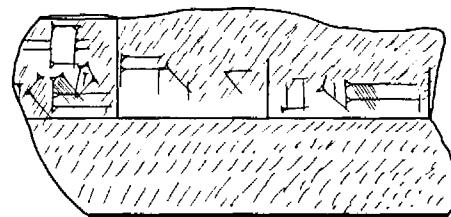

No. 286

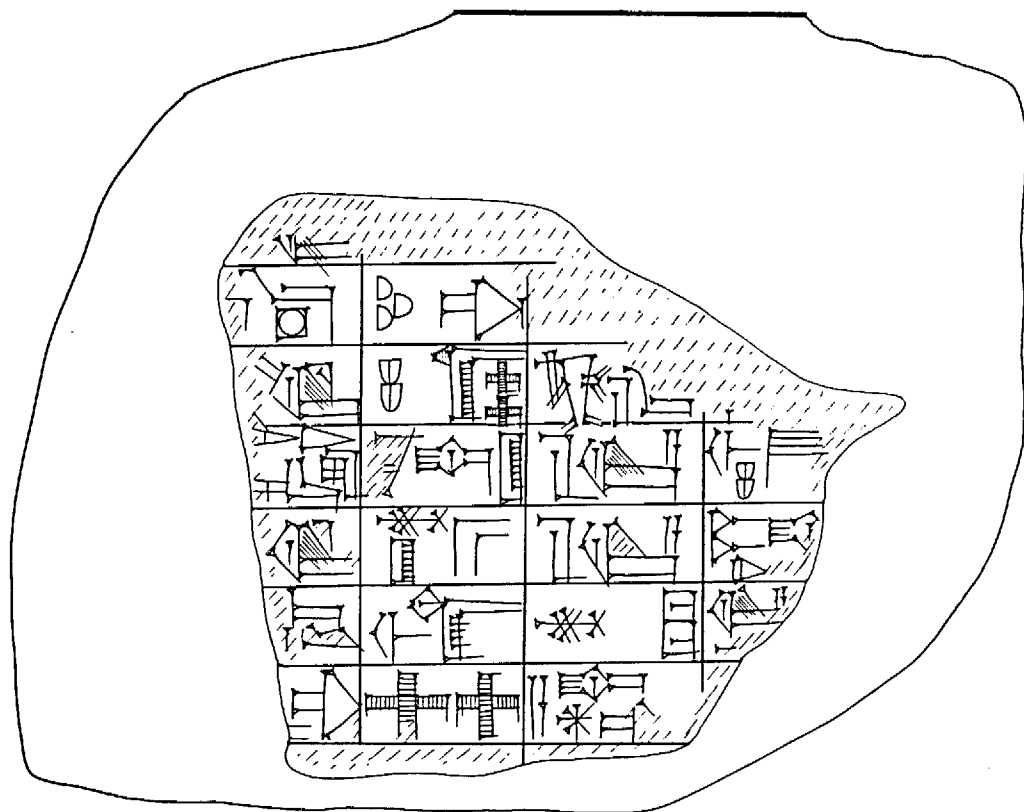

Obverse
No. 287

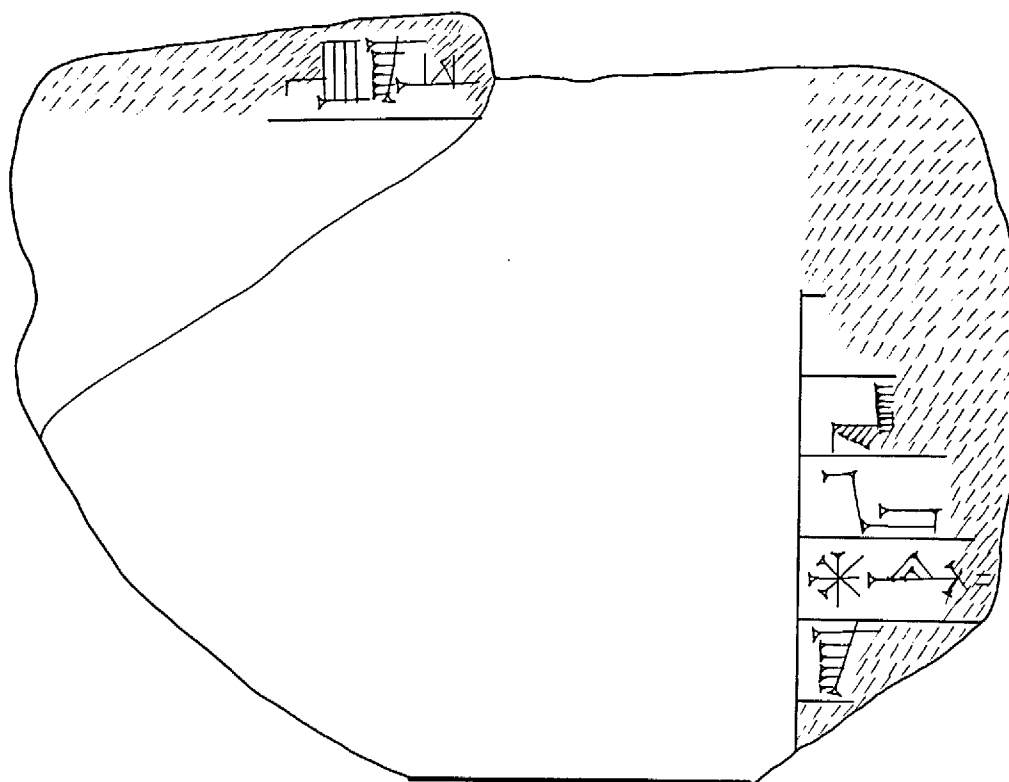

Reverse
No. 287

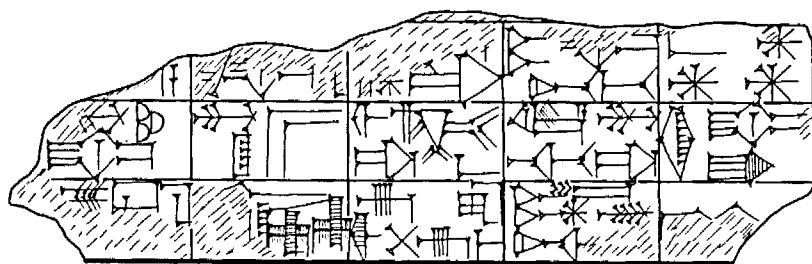

No. 288

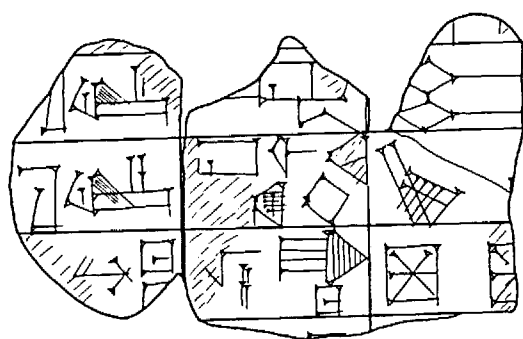

No. 289

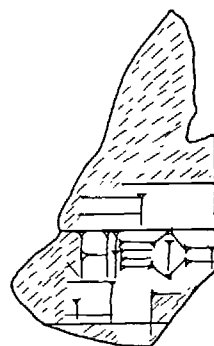

No. 290

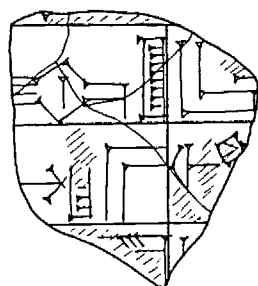

No. 291

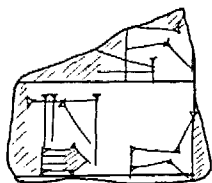

No. 292

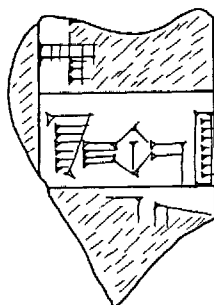

No. 293

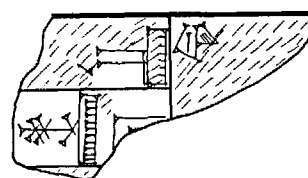

No. 294

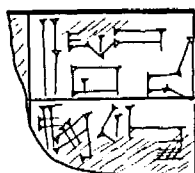

No. 295

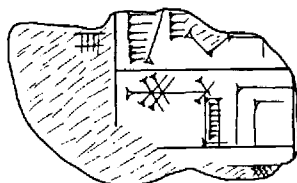

No. 296

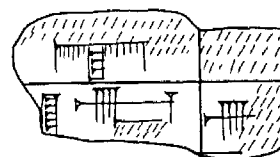

No. 297

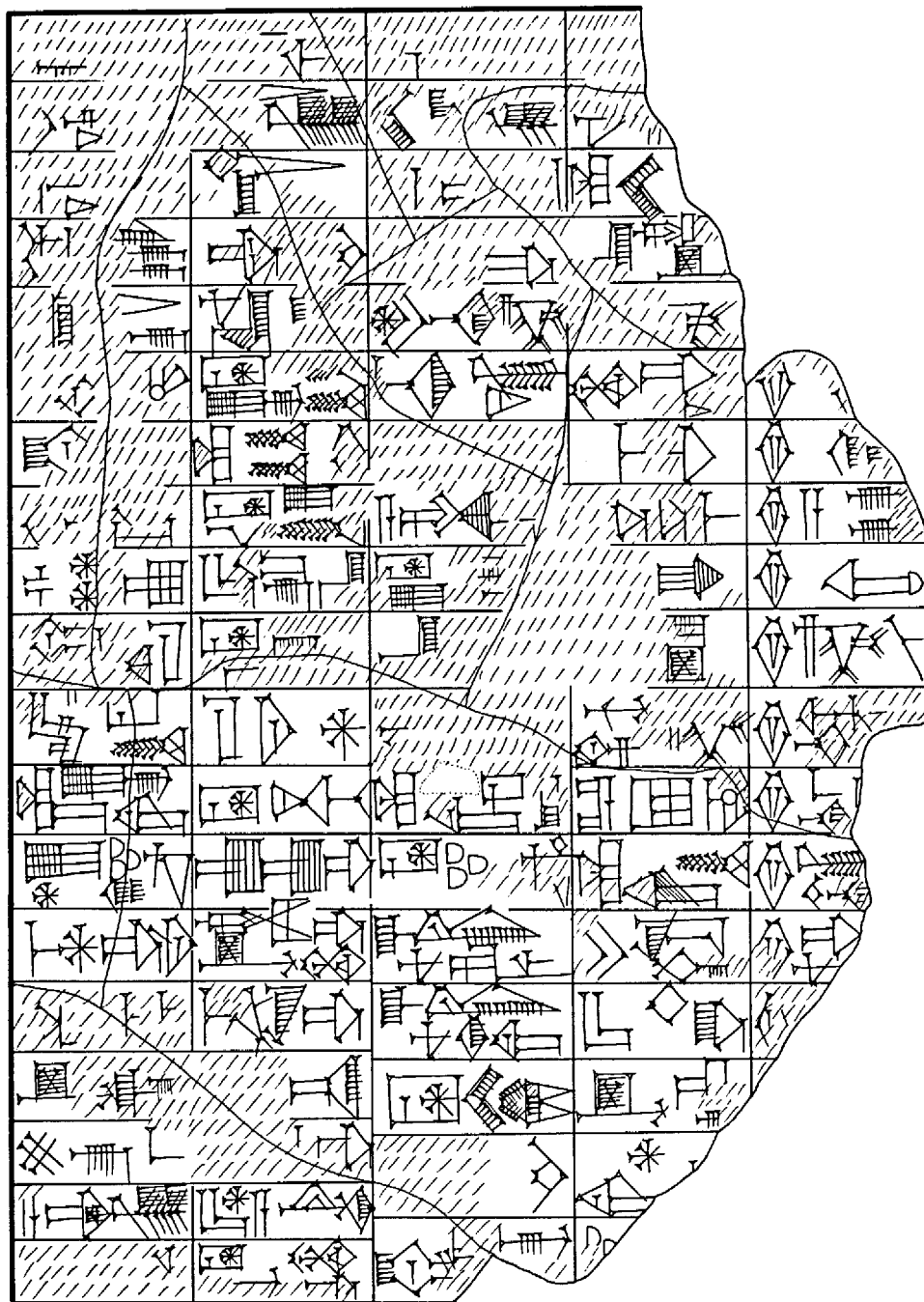

Obverse
No. 298

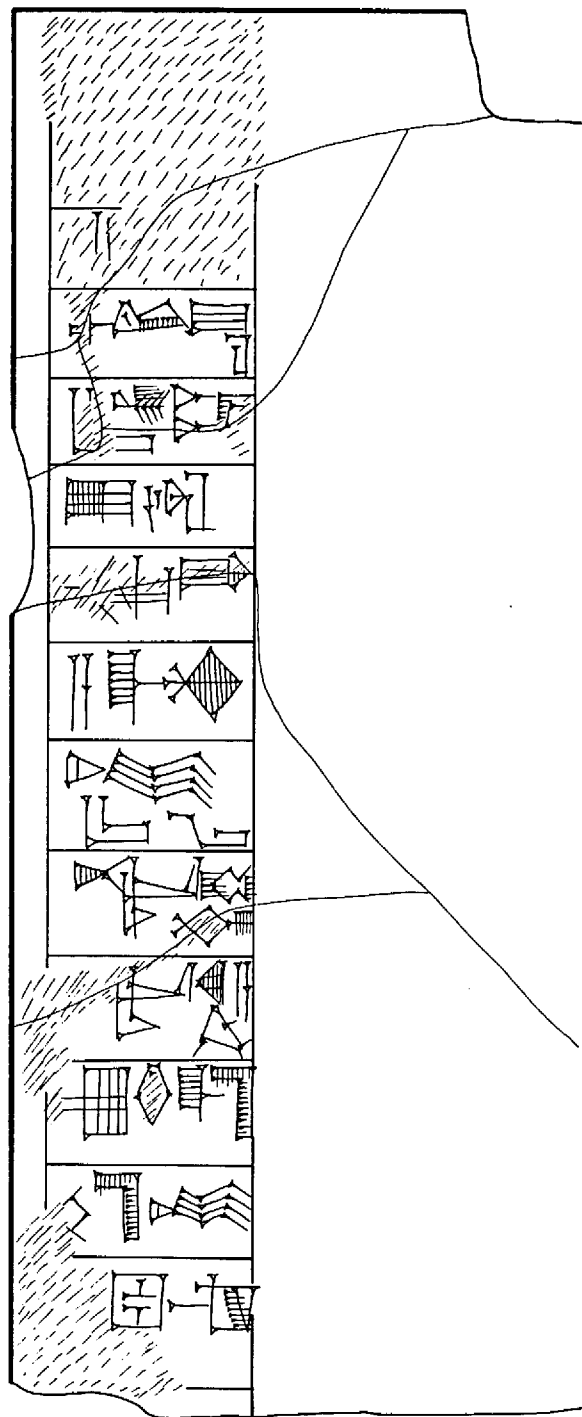

Reverse
No. 298

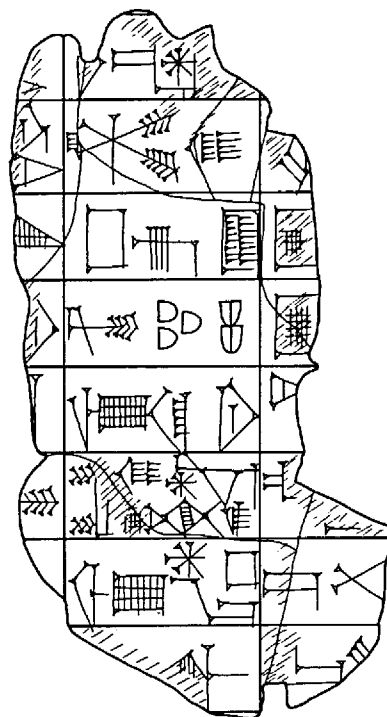

No. 299

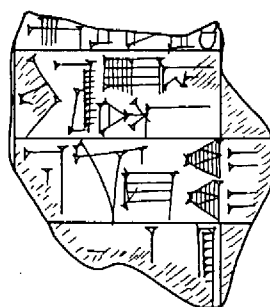

No. 300

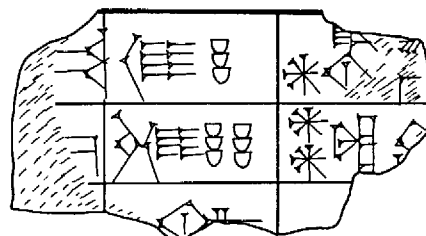

No. 301

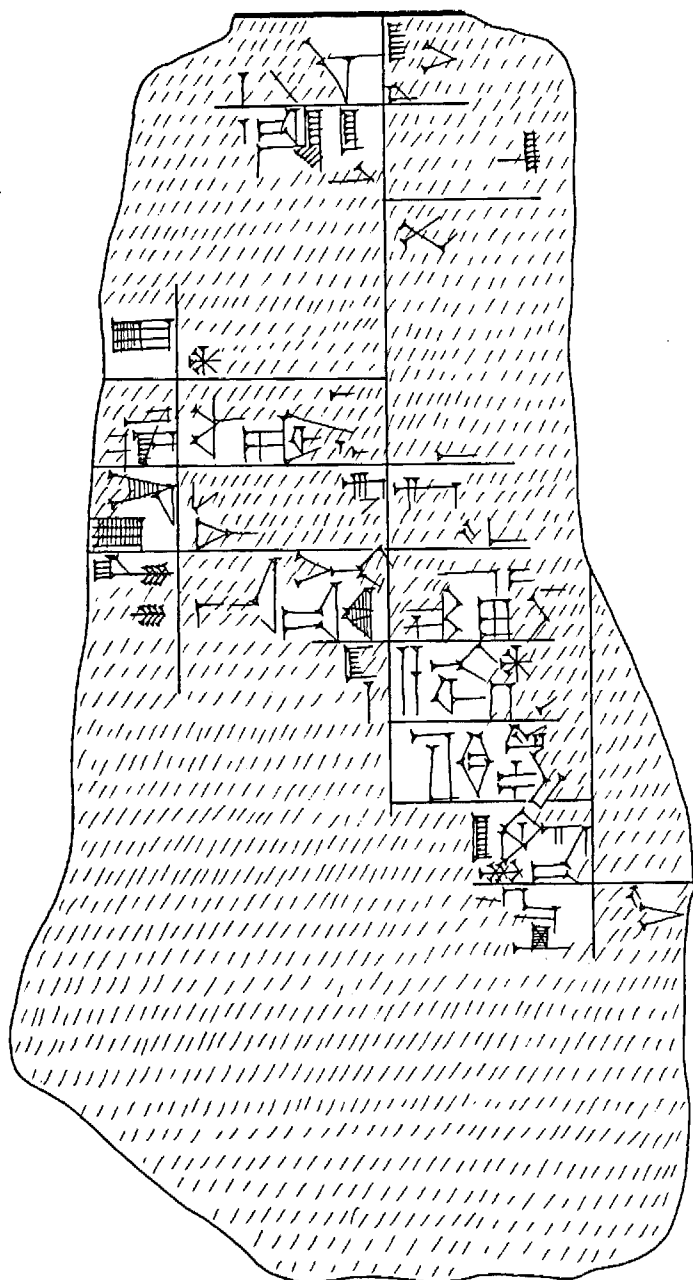

No. 302

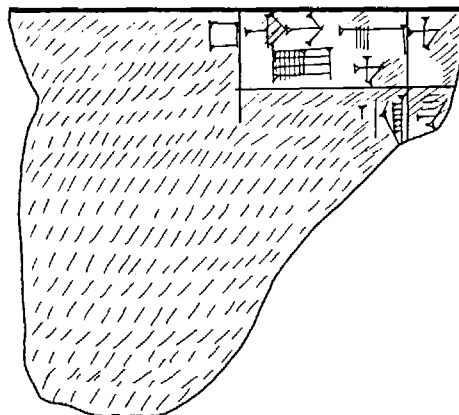

No. 303

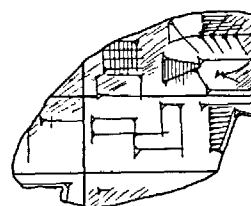

No. 304

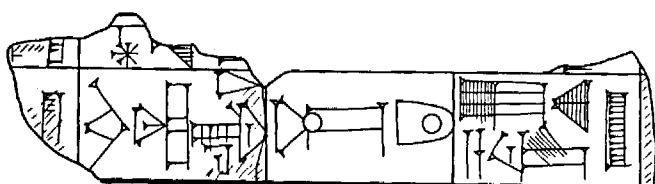

No. 306

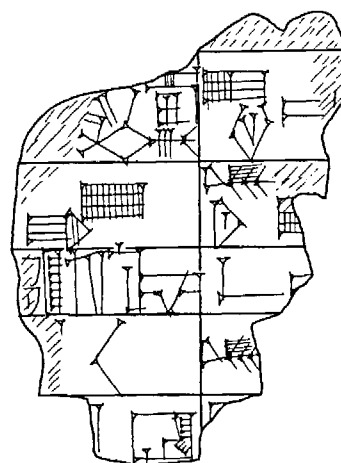

No. 305

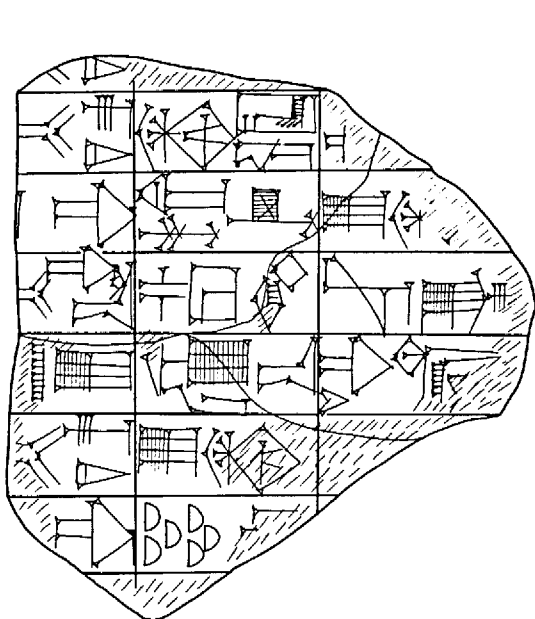

No. 307

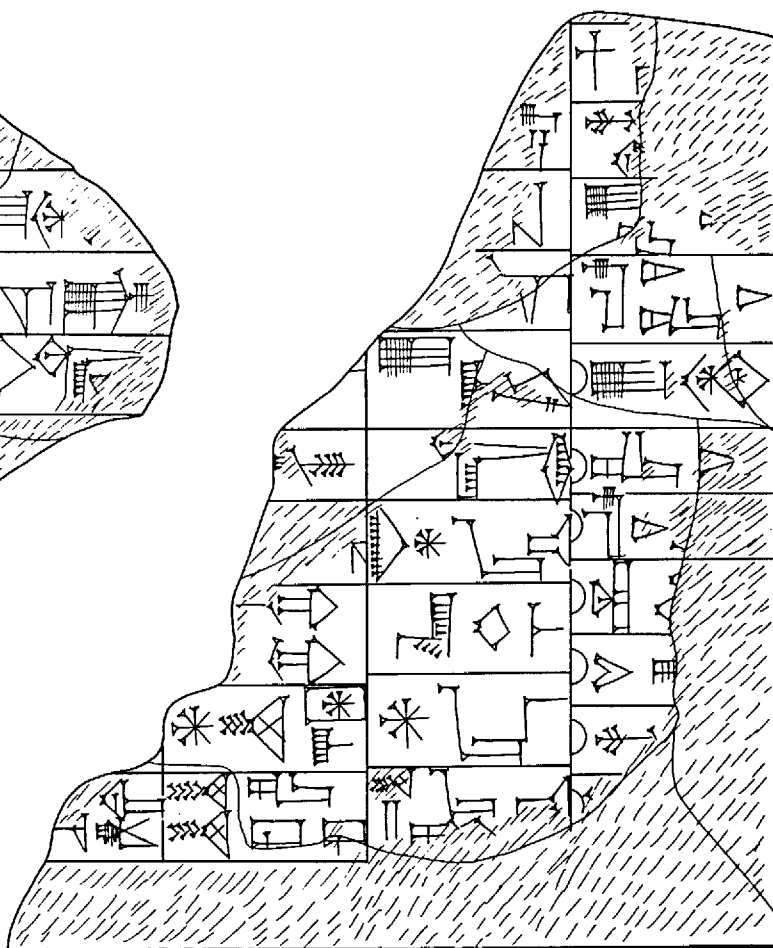

Obverse
No. 308

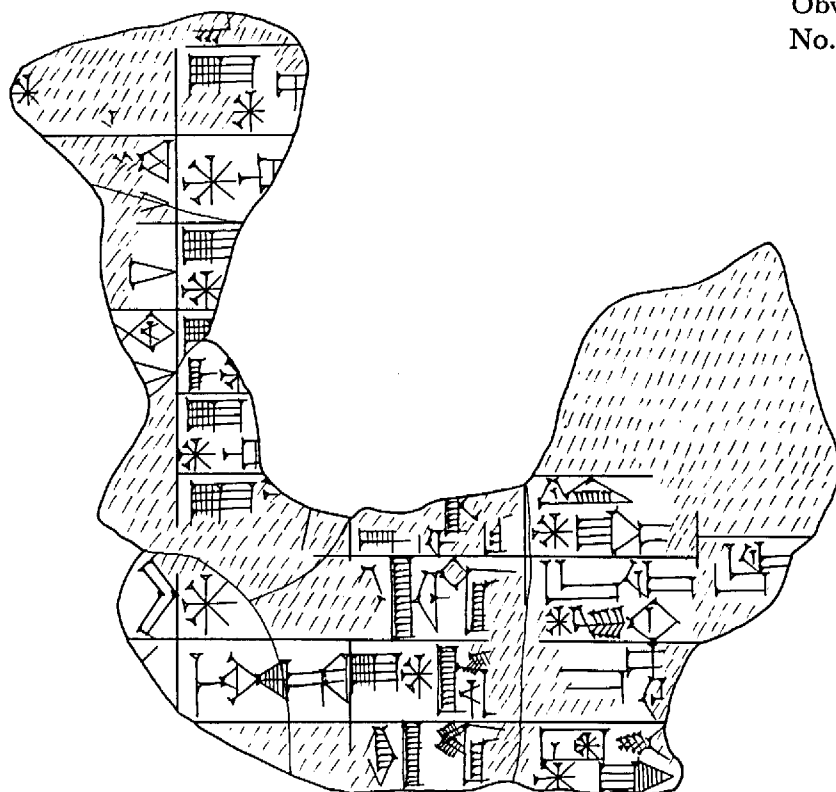

No. 309

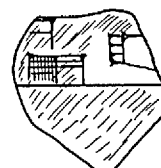

No. 310

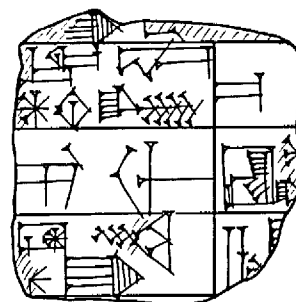

No. 311

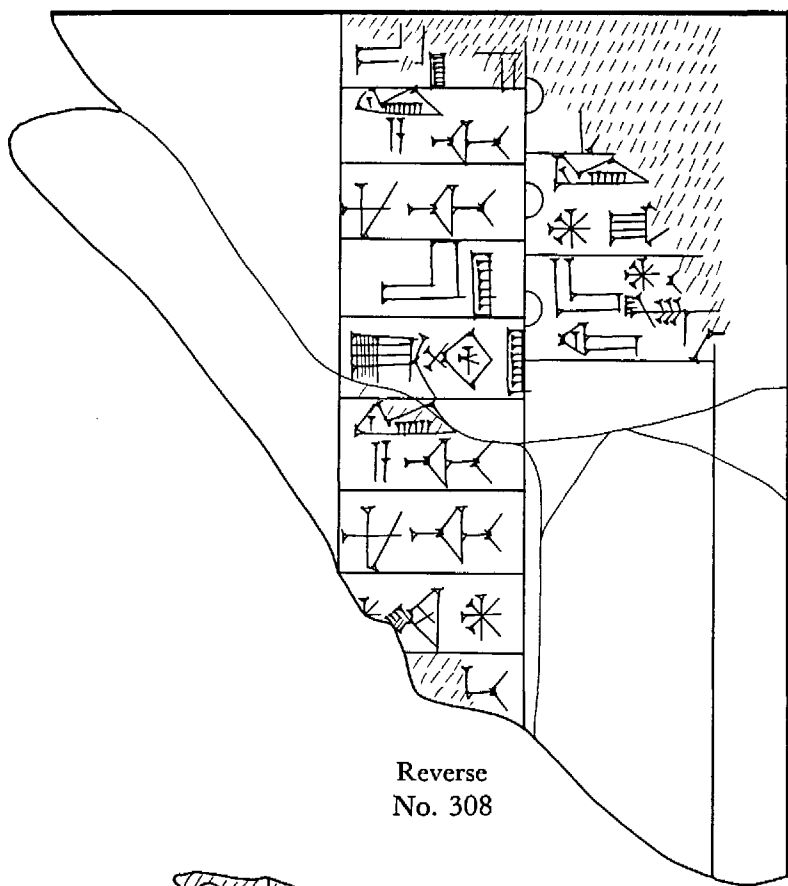

Reverse
No. 308

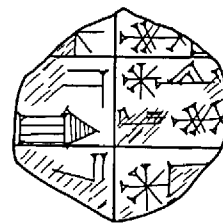

No. 312

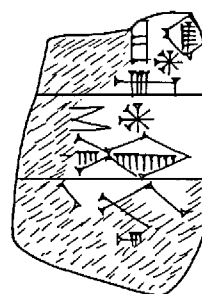

No. 313

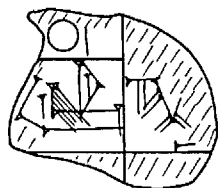

No. 314

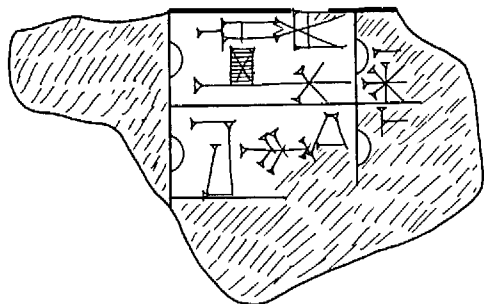

No. 315

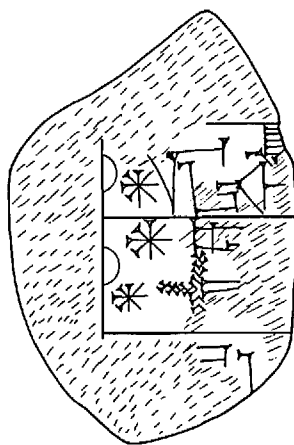

No. 316



No. 317

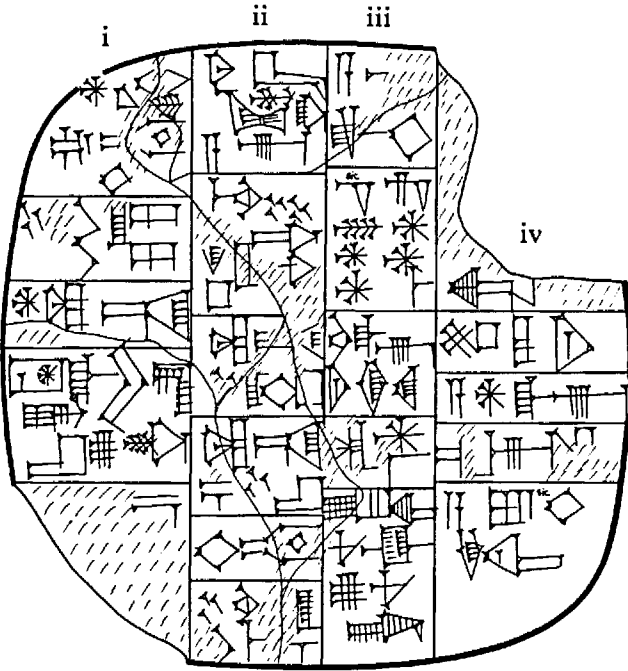

Obverse
No. 318

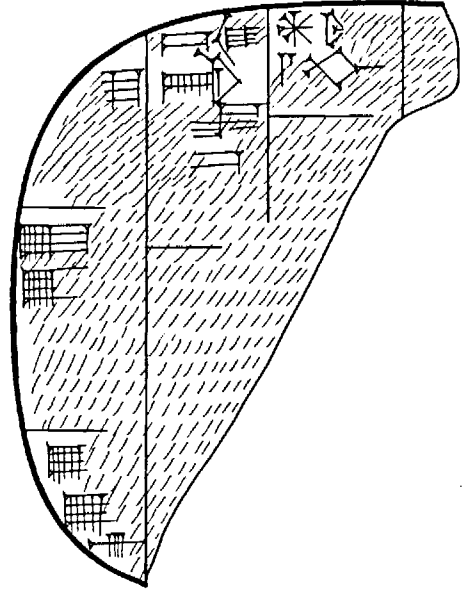

No. 319

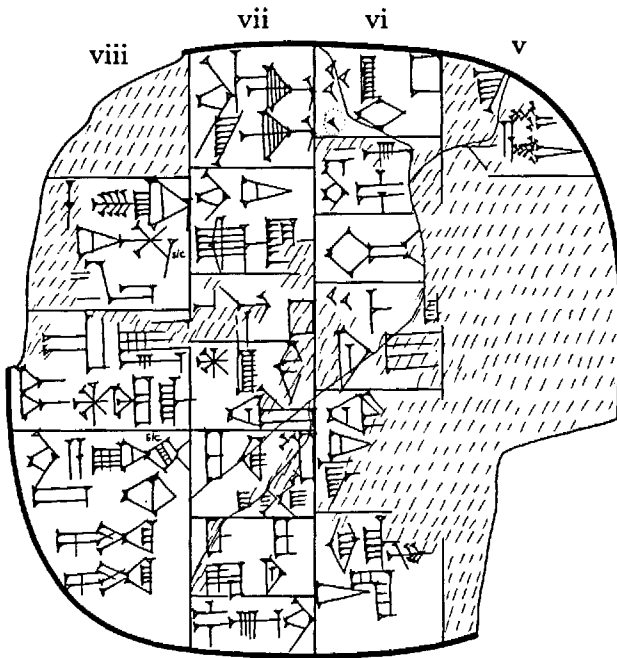

Reverse
No. 318

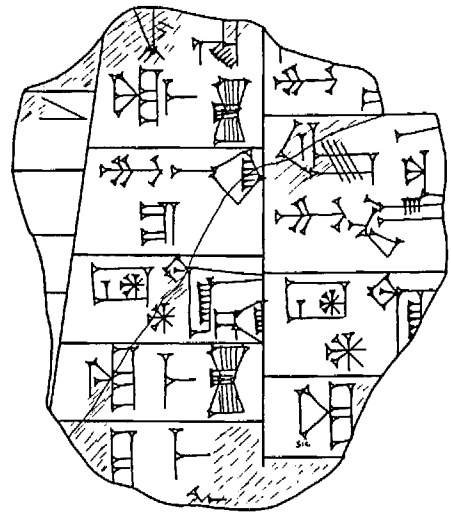

No. 320

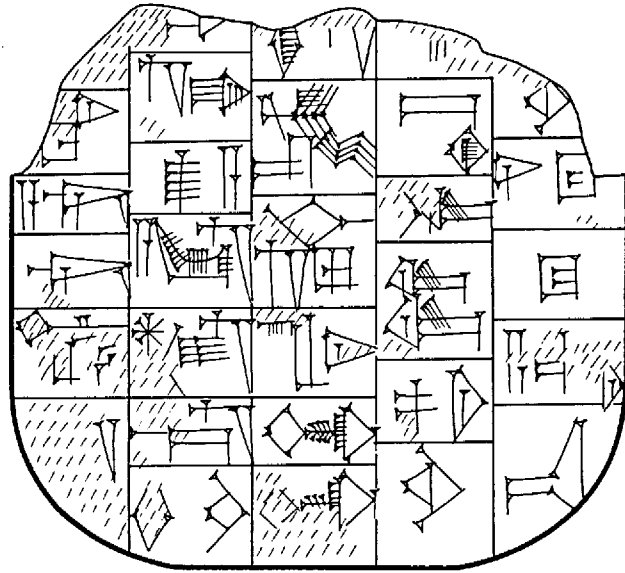

Obverse
No. 321

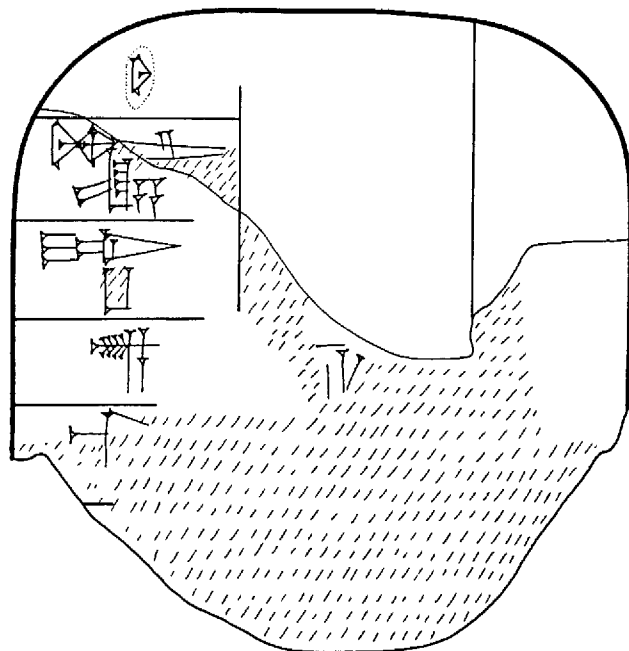

Reverse
No. 321

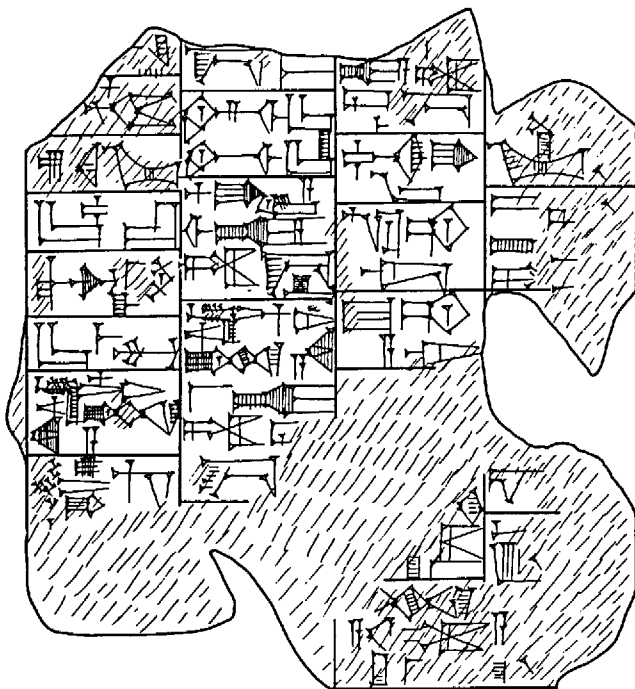

Obverse
No. 322

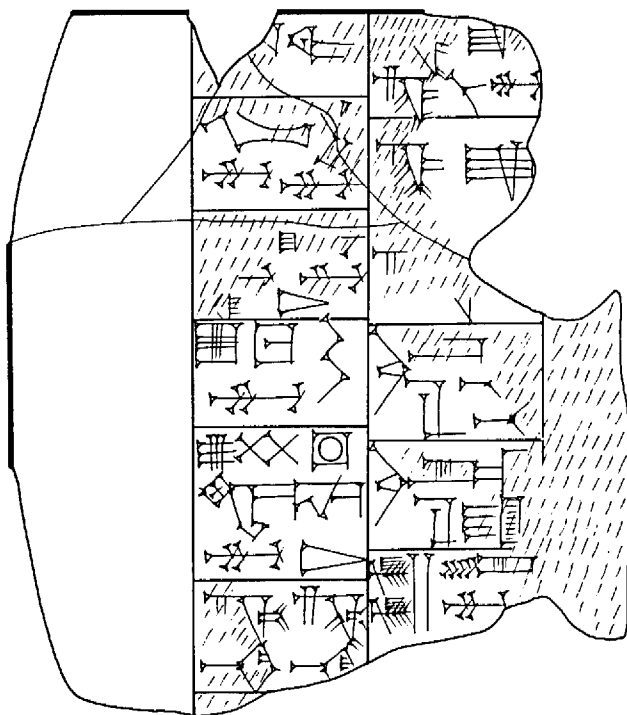

Reverse
No. 322

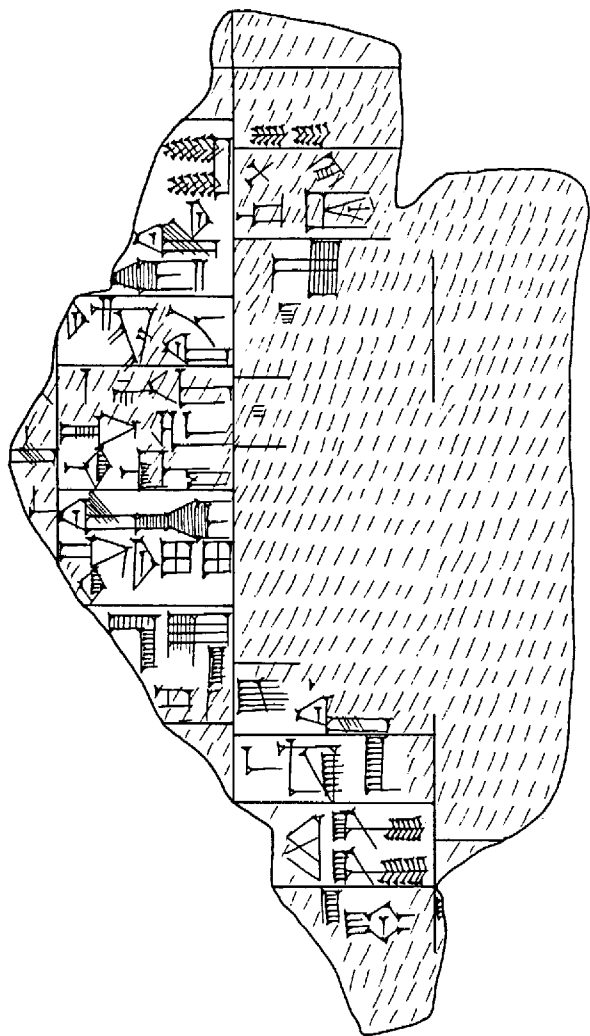

Obverse
No. 323

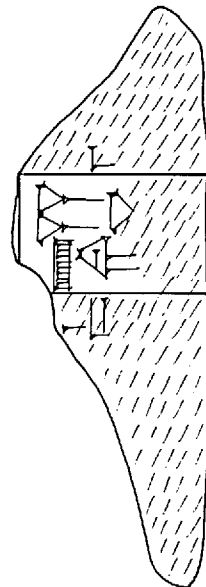

Reverse
No. 323

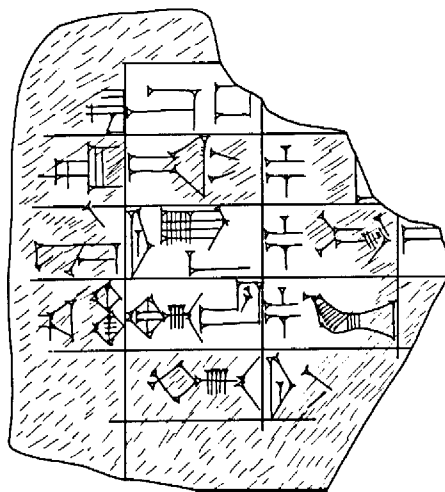

No. 324



No. 325



No. 326

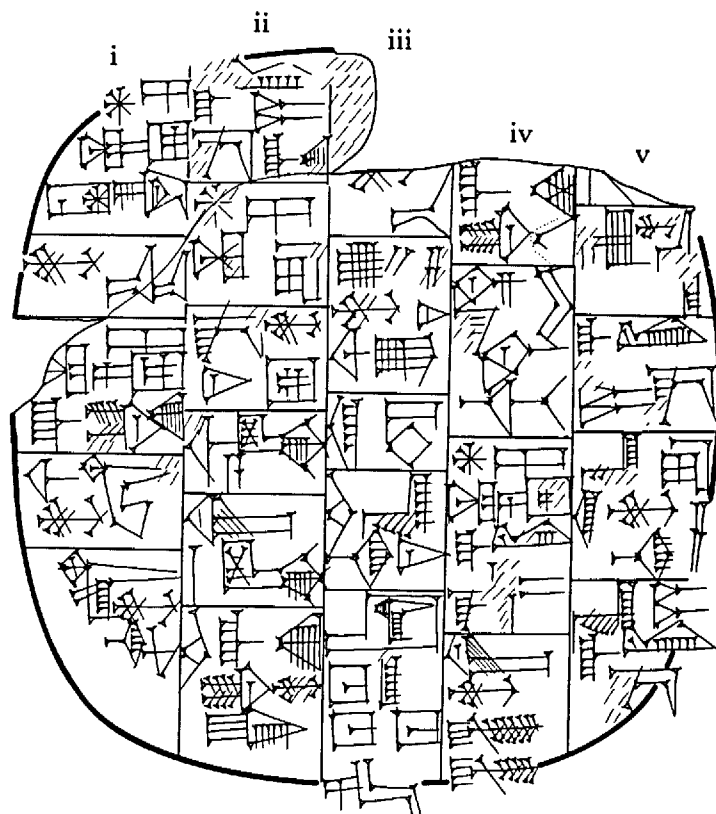

Obverse
No. 327

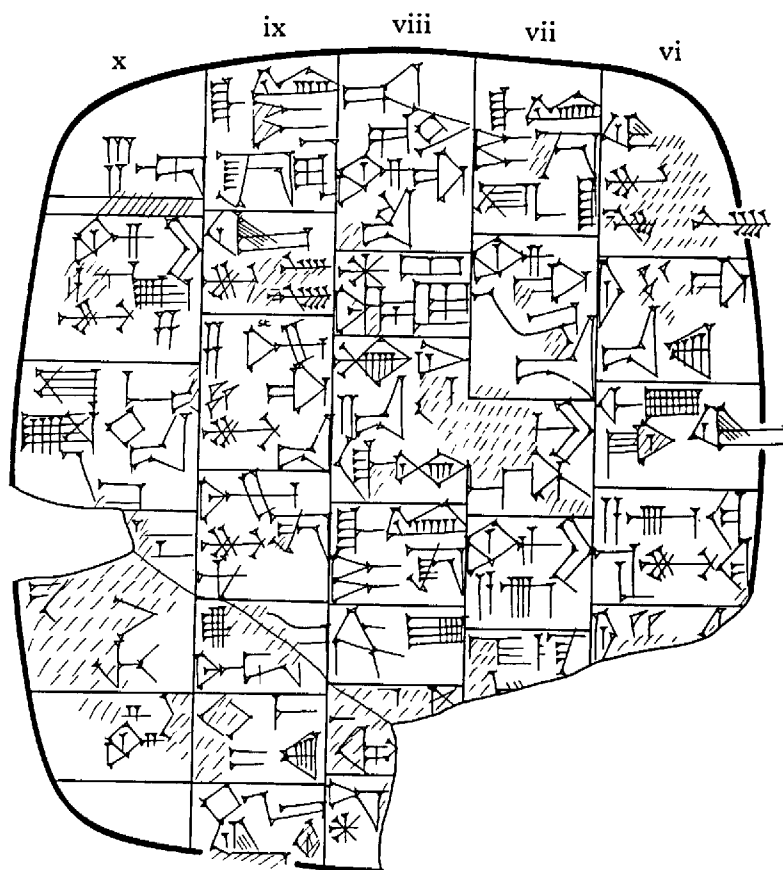

Reverse
No. 327

PLATE 147

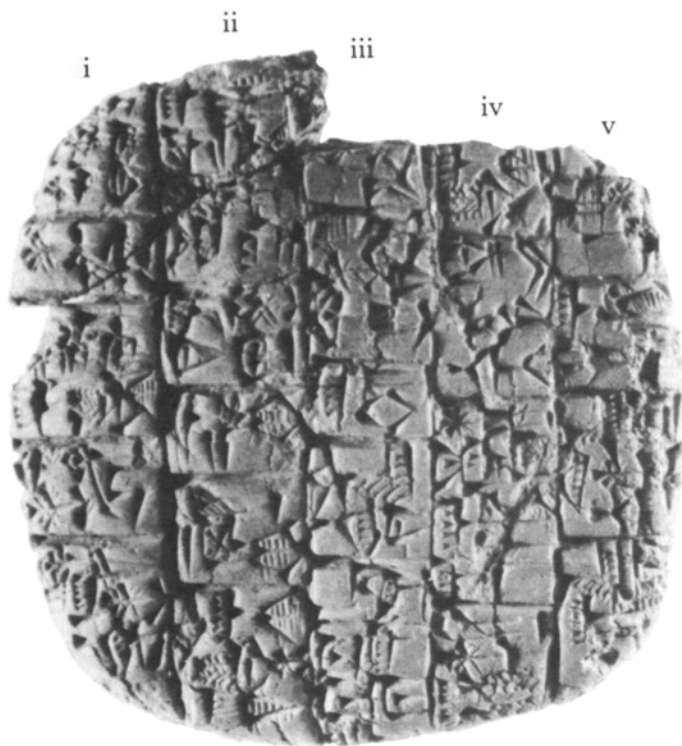

Obverse
No. 327

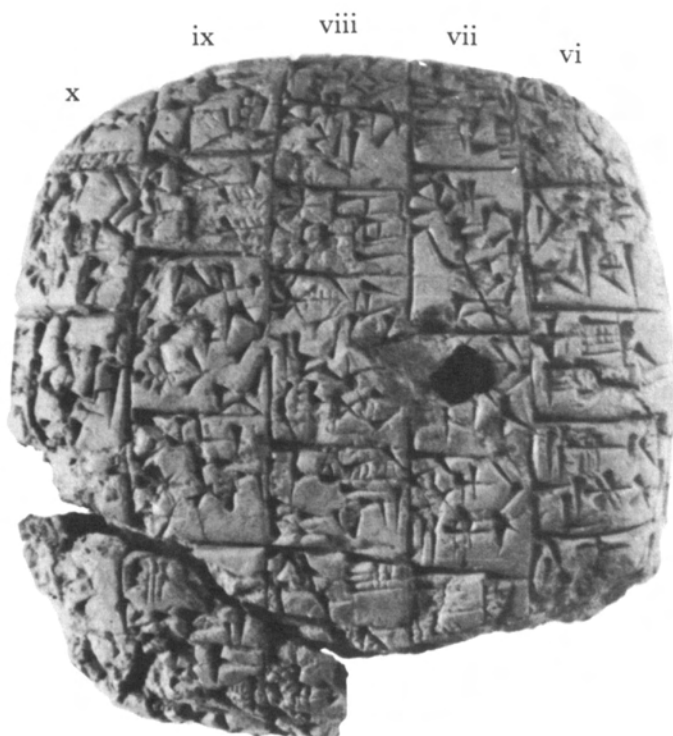

Reverse
No. 327

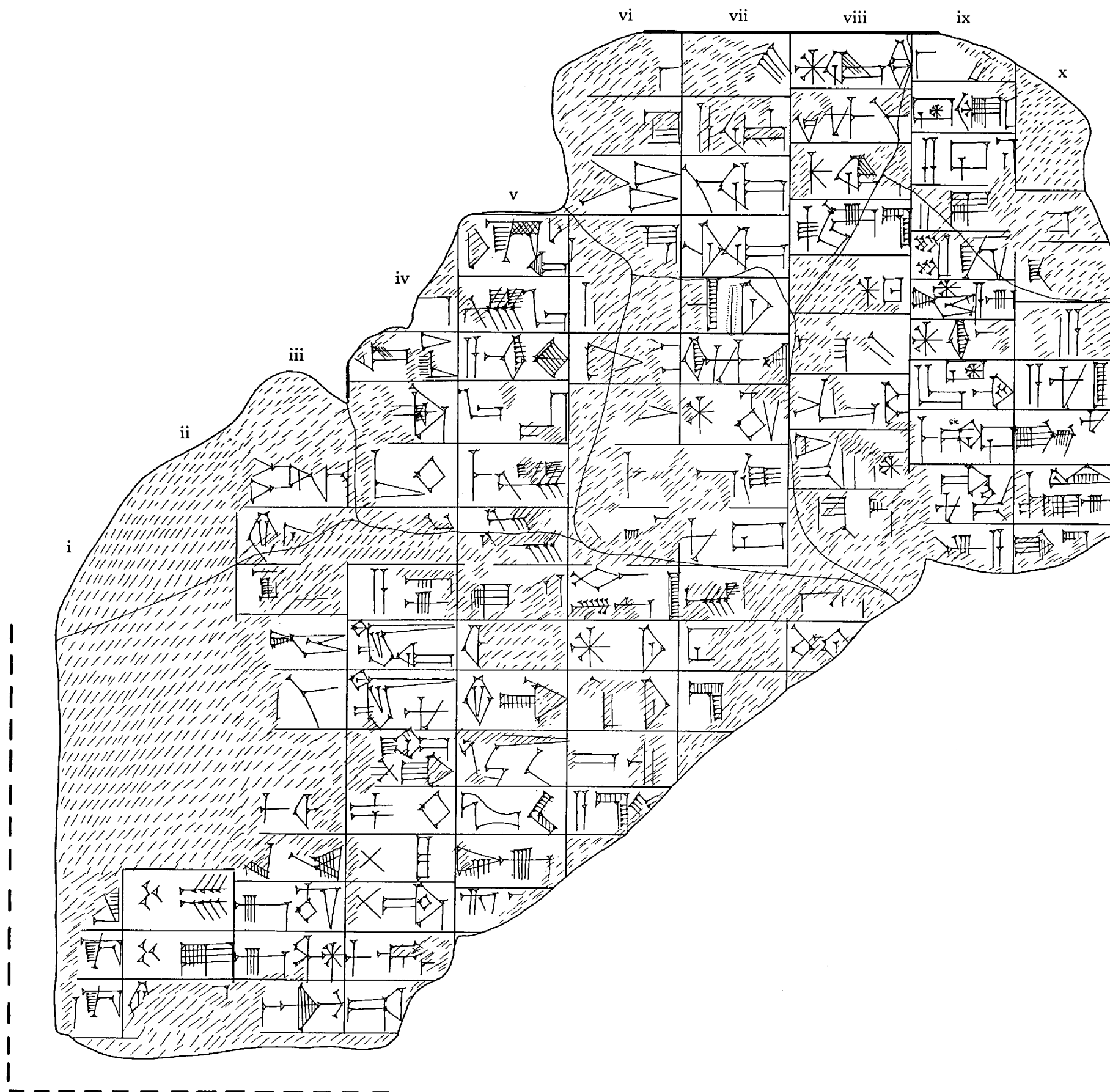

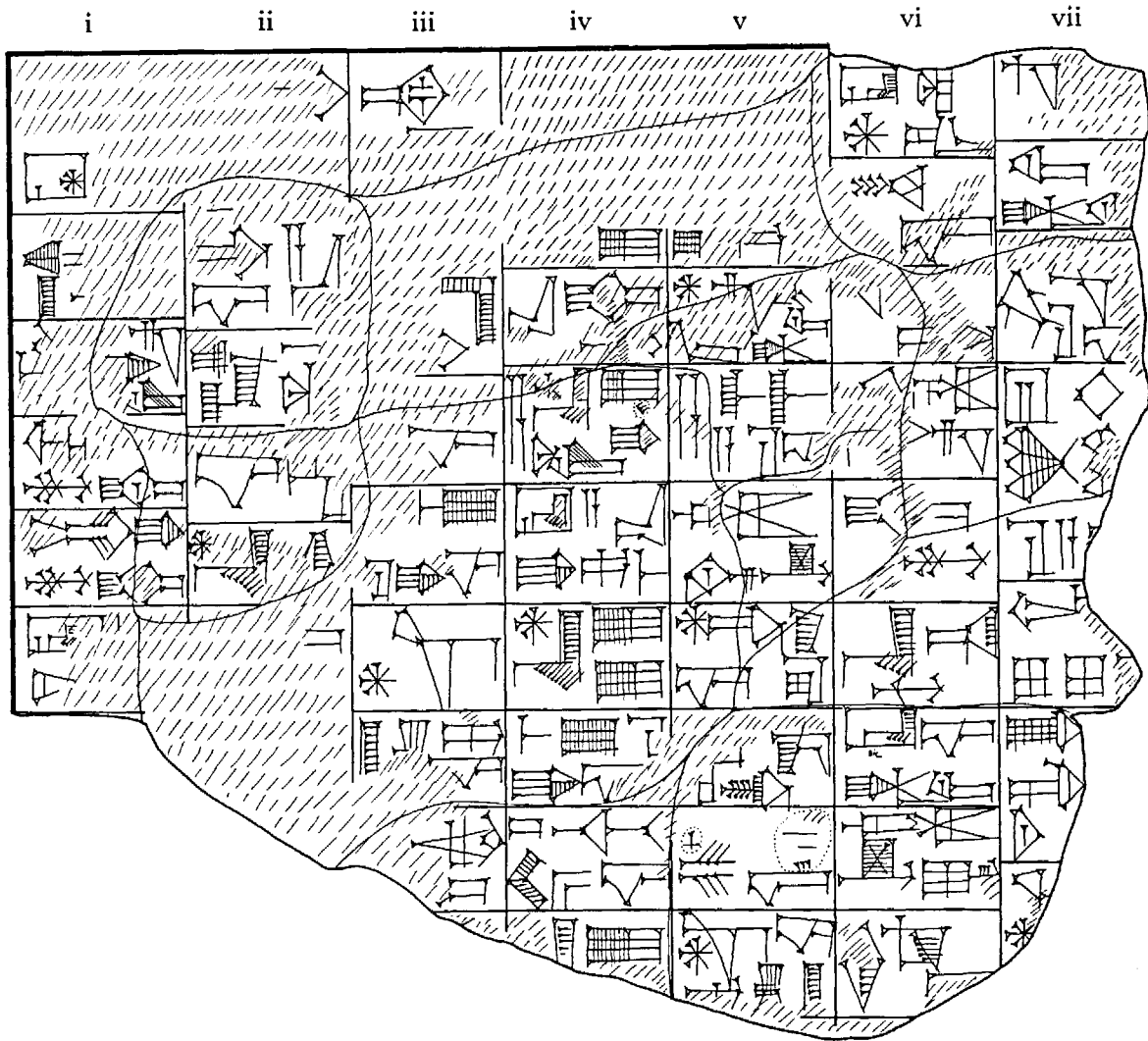

No. 329

PLATE 150



Obverse
No. 330



Reverse
No. 330

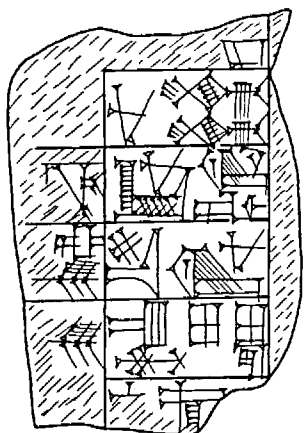

No. 332

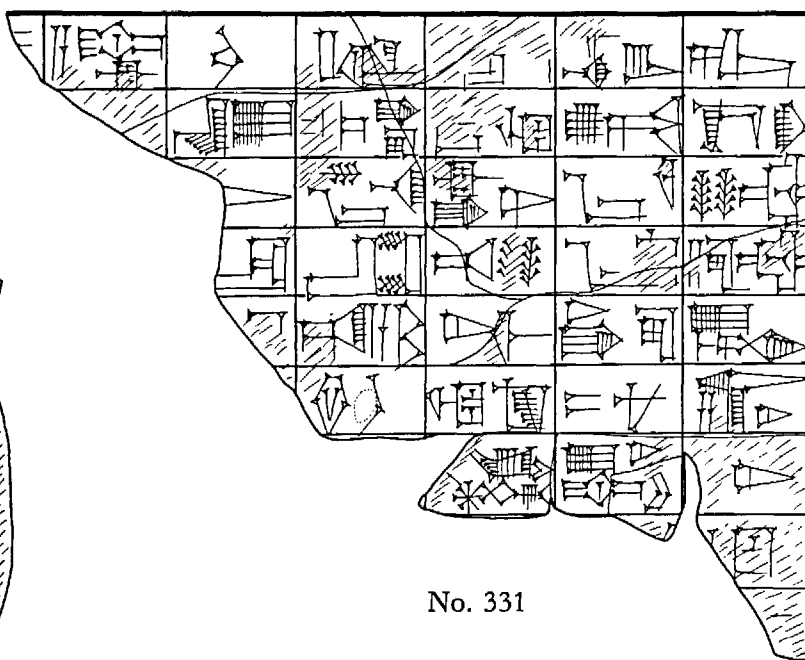

No. 331

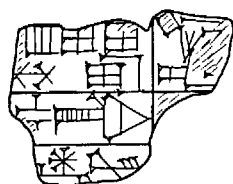

No. 333

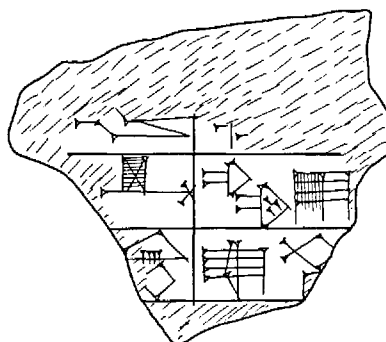

No. 334

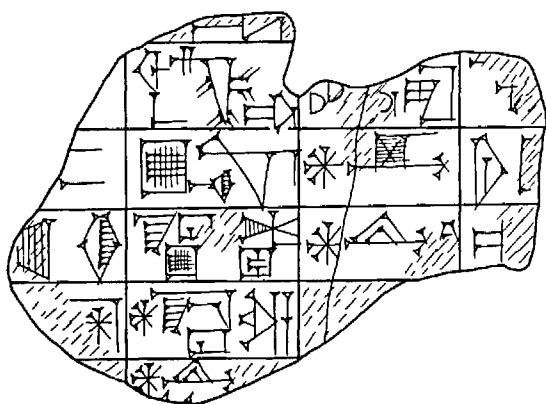

No. 335

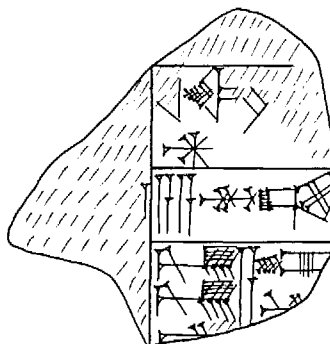

No. 336

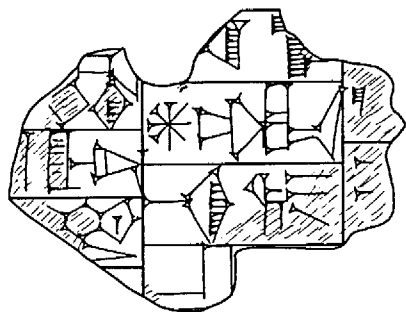

No. 337

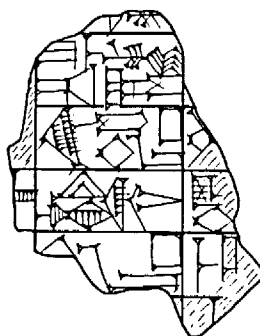

No. 338

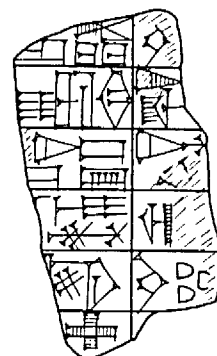

No. 339

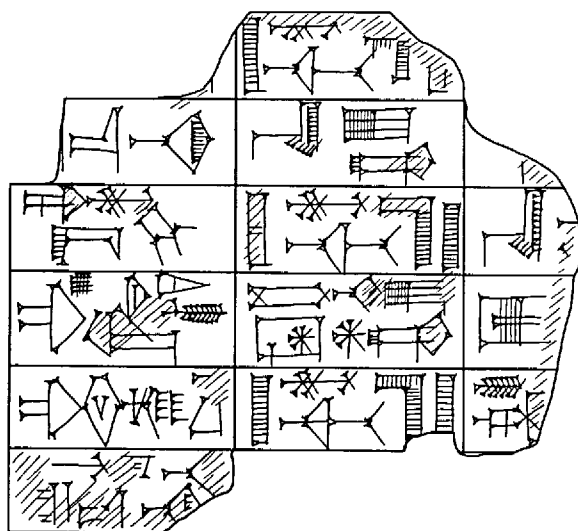

No. 340

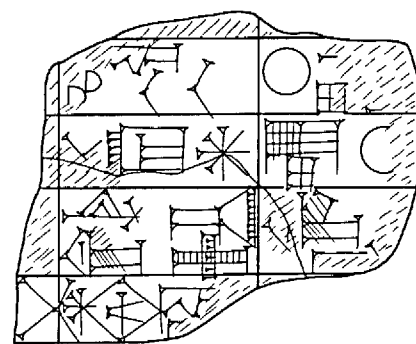

No. 341

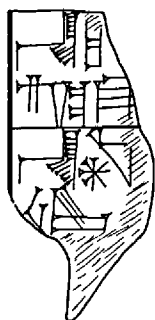

No. 343

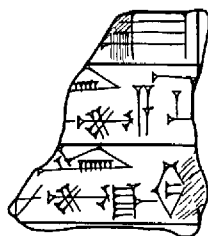

No. 344

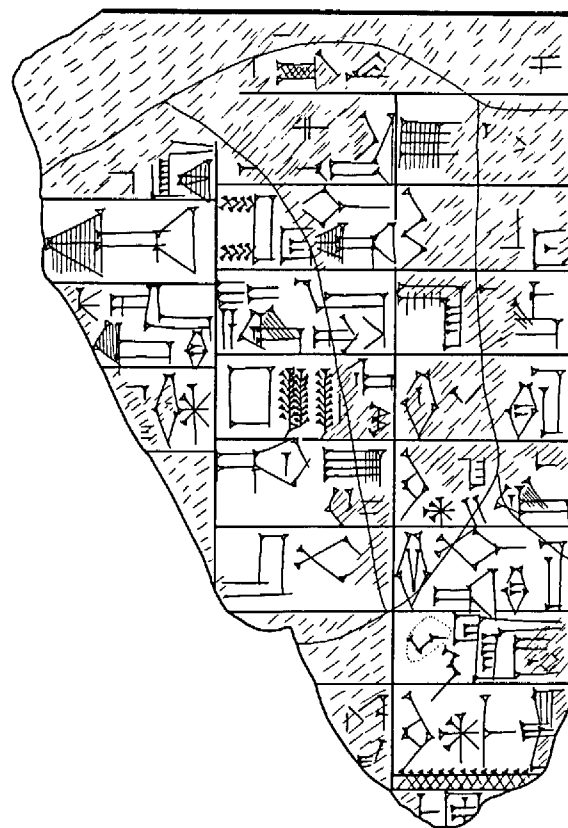

No. 342

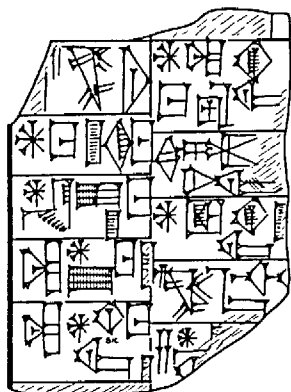

No. 345

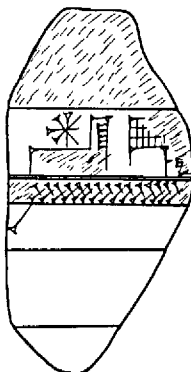

No. 346

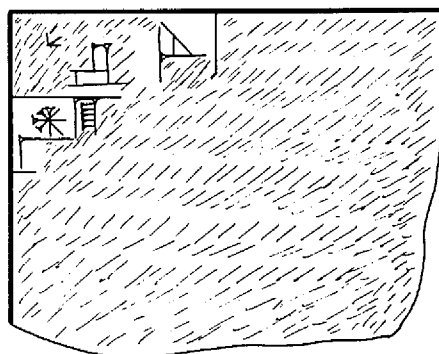

No. 347

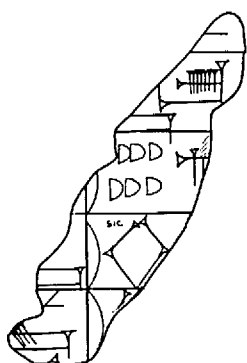

No. 348

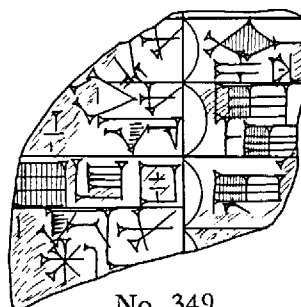

No. 349

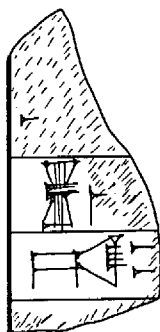

No. 351

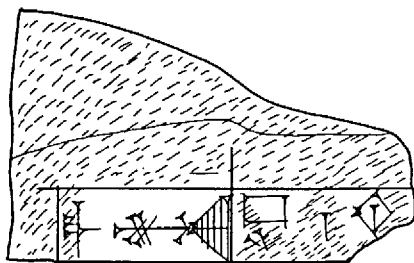

No. 352

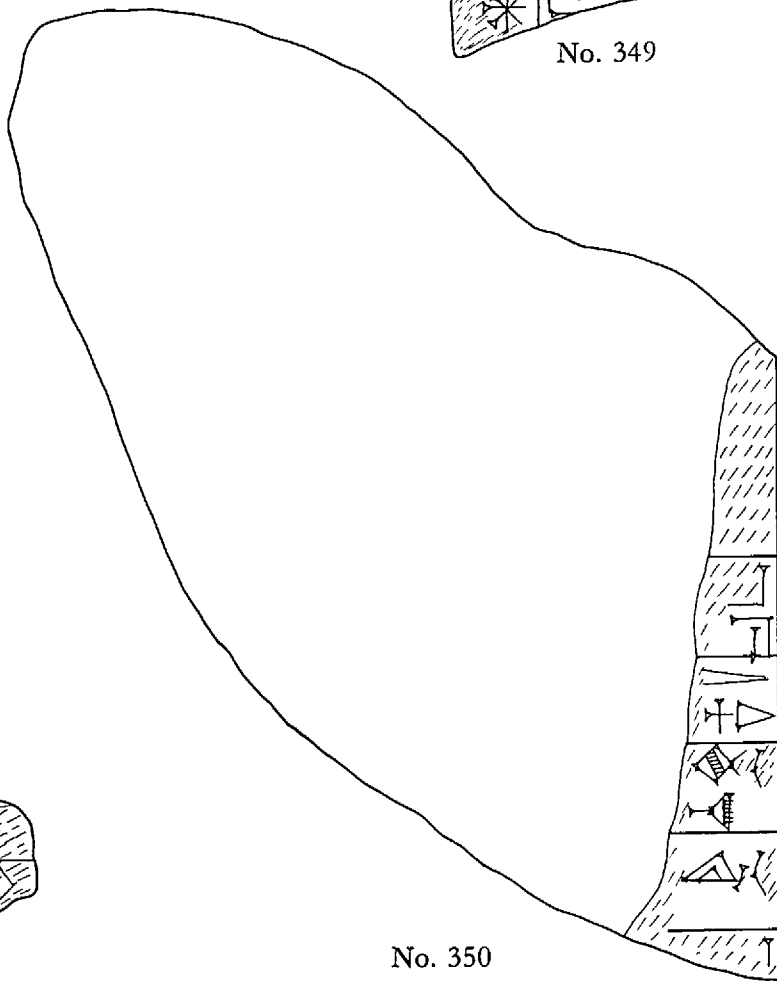

No. 350

PLATE 154

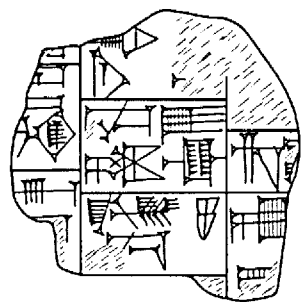

No. 353

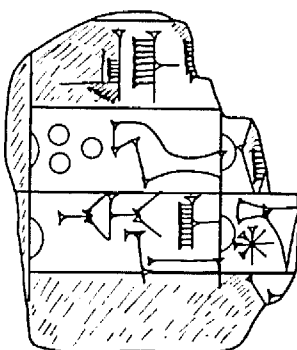

No. 354

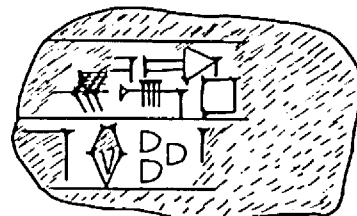

No. 355

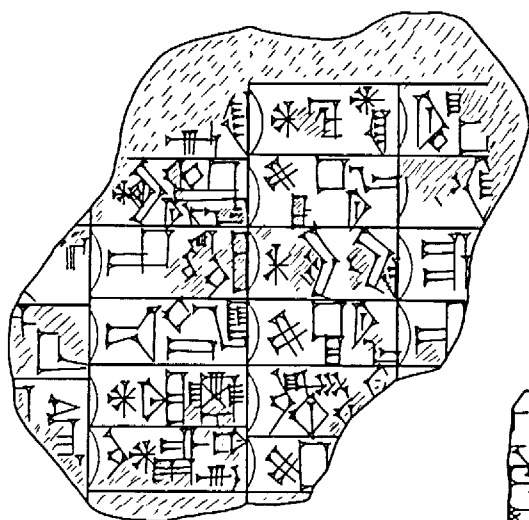

No. 356

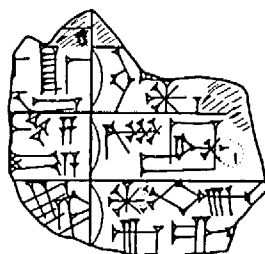

No. 358

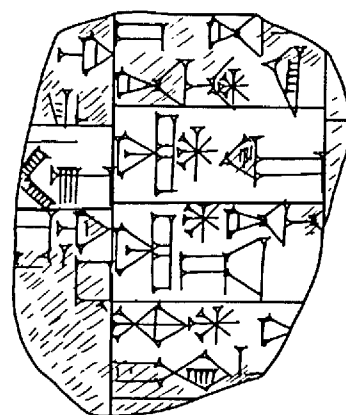

No. 357

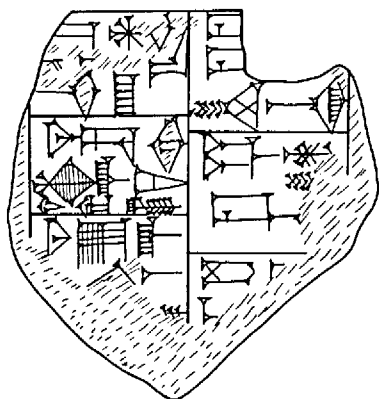

No. 359

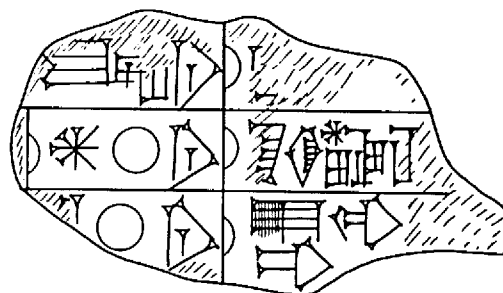

No. 360

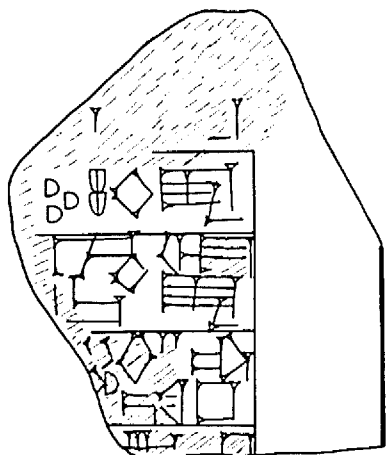

No. 361

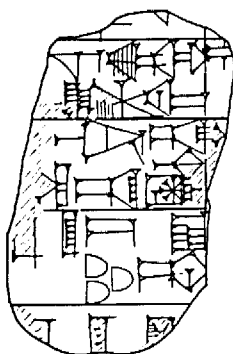

No. 362

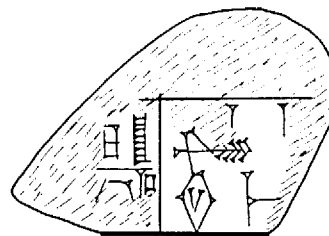

No. 363

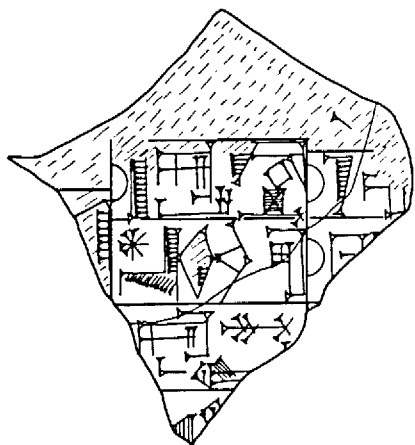

No. 364

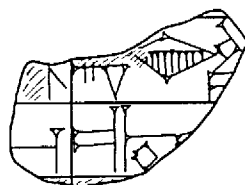

No. 365

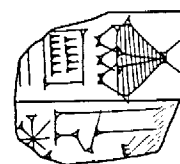

No. 366

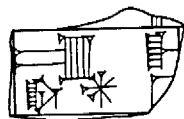

No. 367

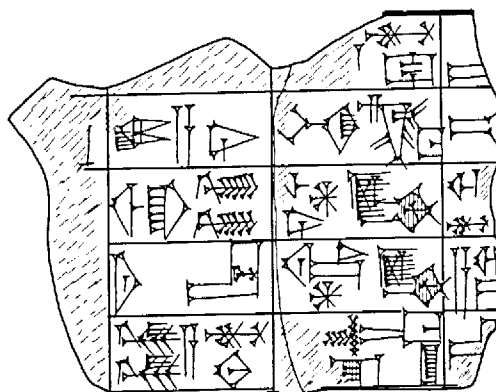

No. 368

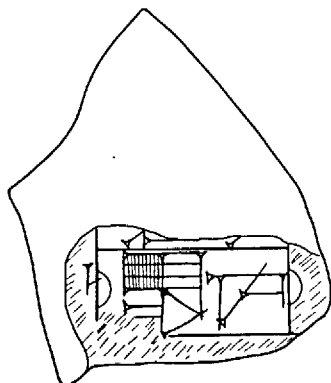

No. 369

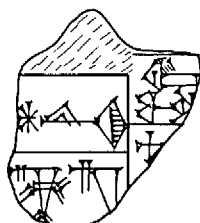

No. 370

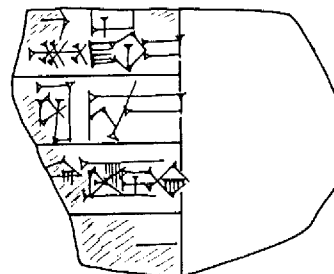

No. 371

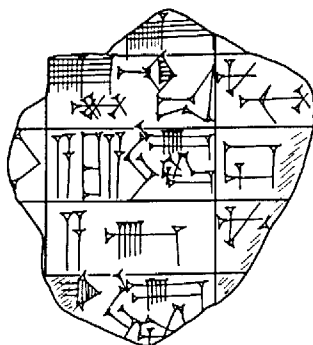

No. 372

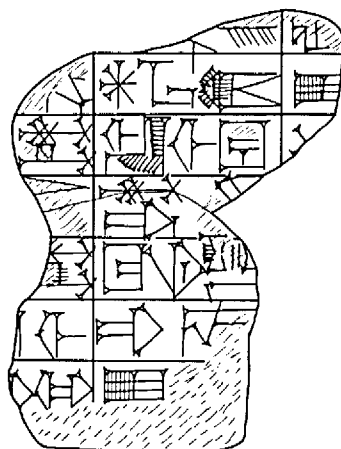

No. 373

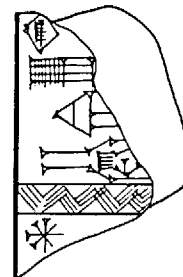

No. 374

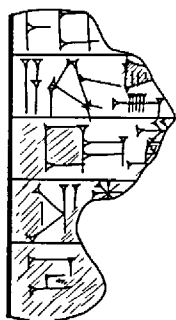

No. 375

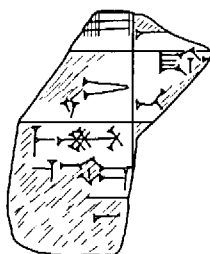

No. 376

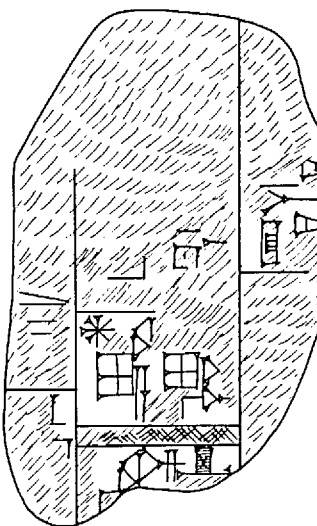

No. 377

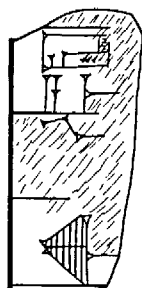

No. 378

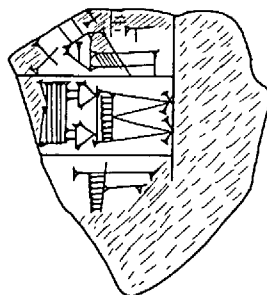

No. 379

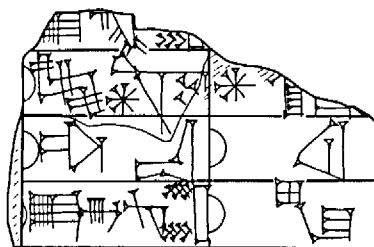

No. 380

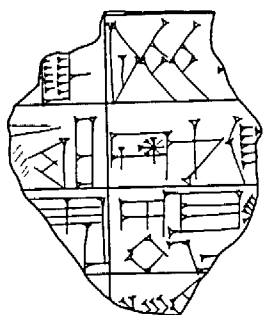

No. 381

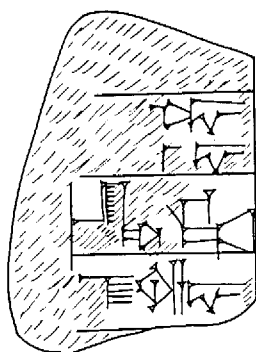

No. 382

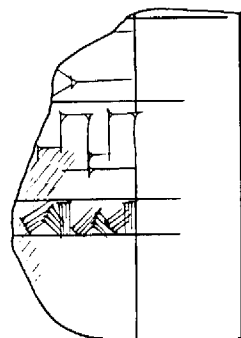

No. 383

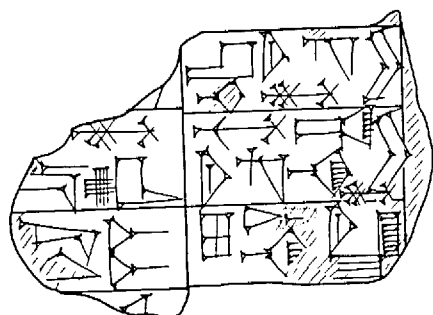

No. 384

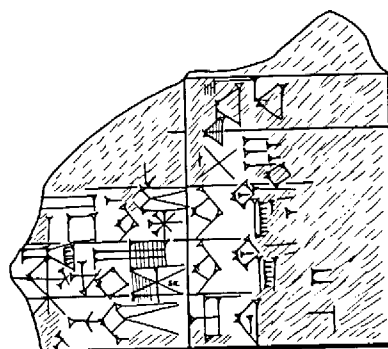

No. 385

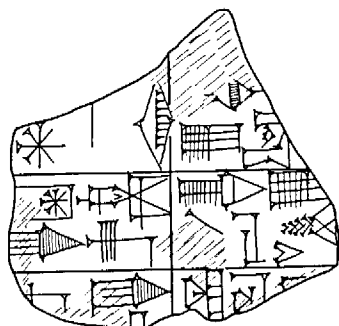

No. 386

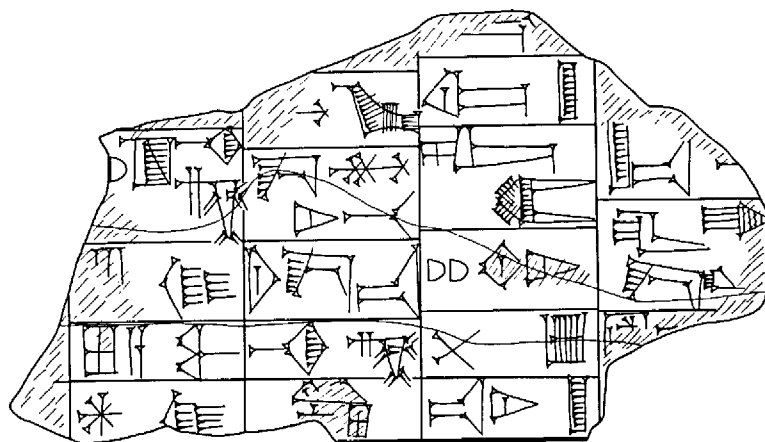

No. 387

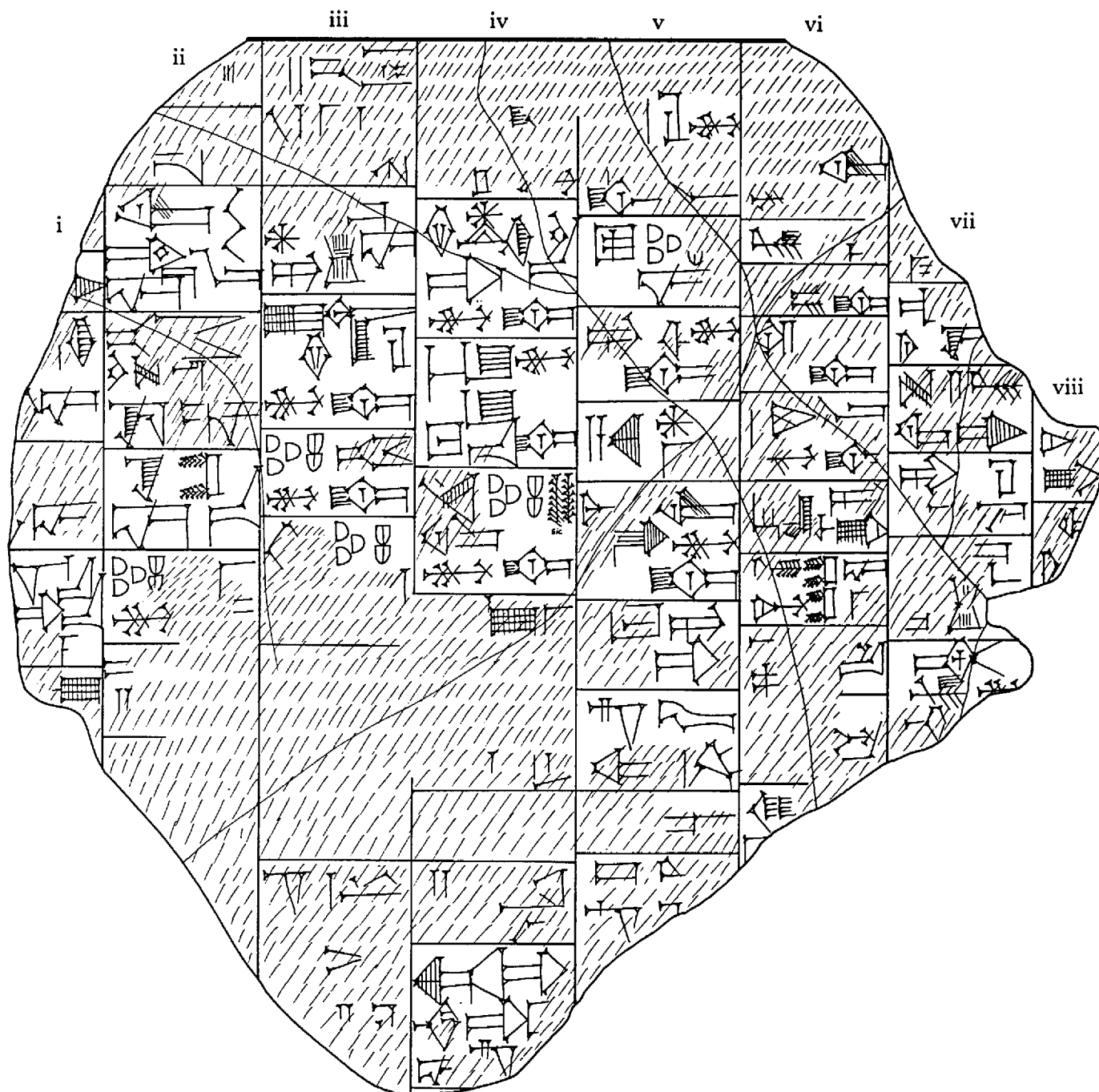

Obverse
No. 388

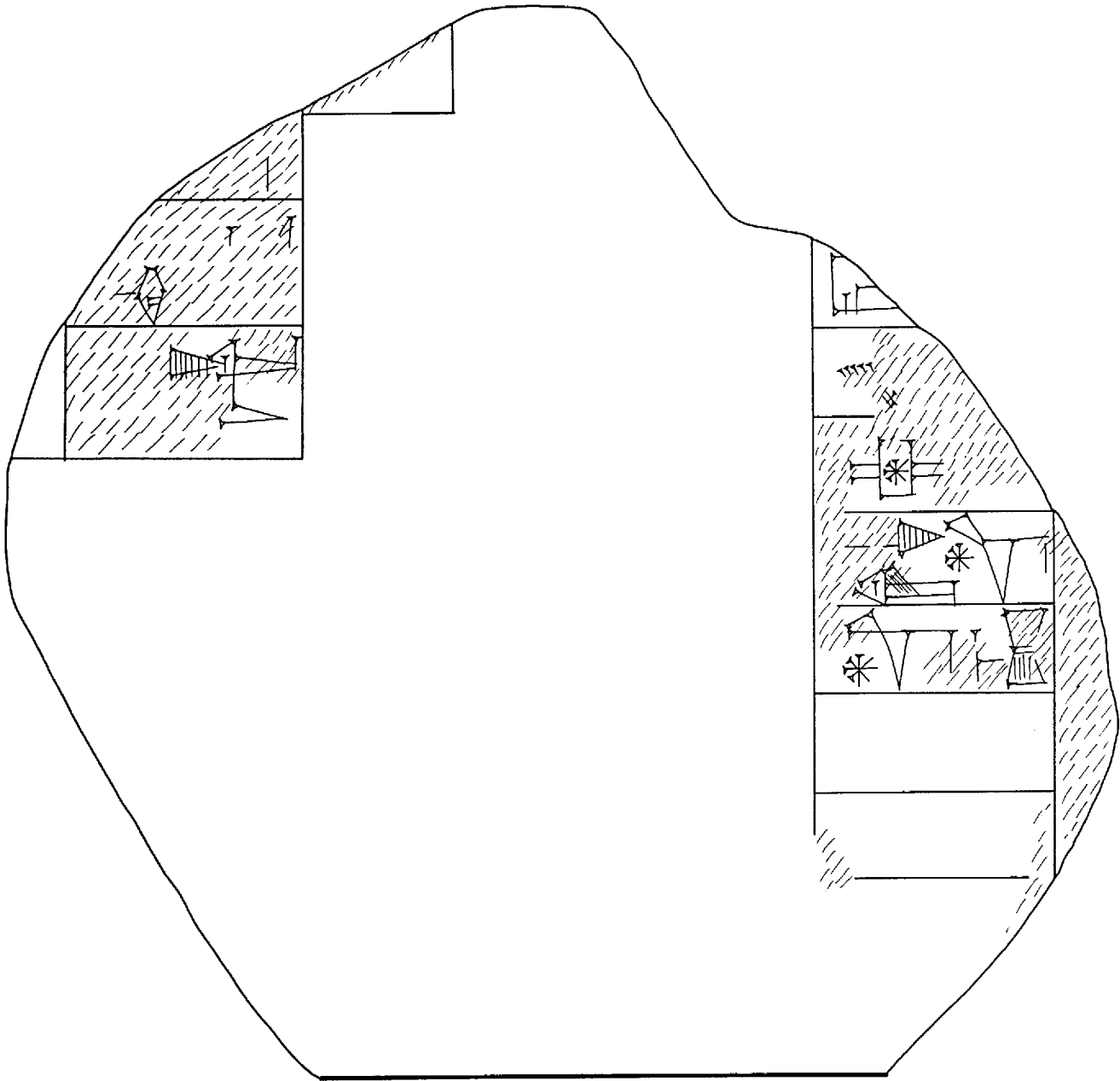

Reverse
No. 388

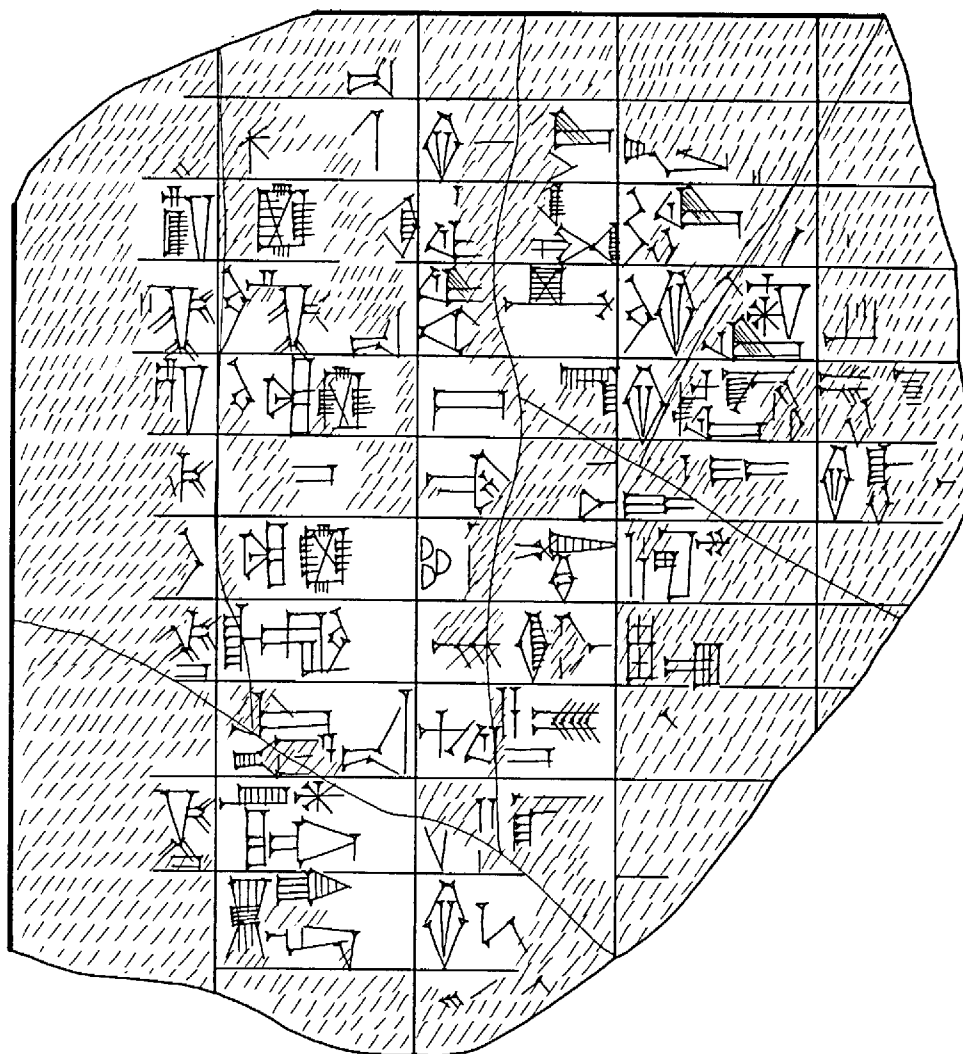

No. 389

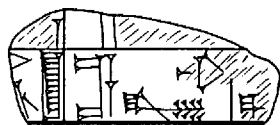

No. 390

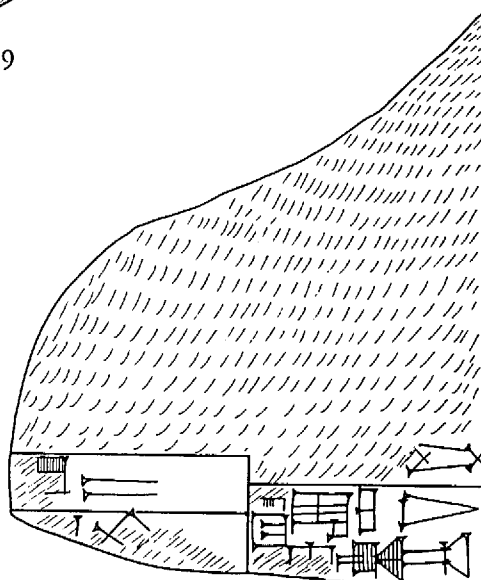

No. 391

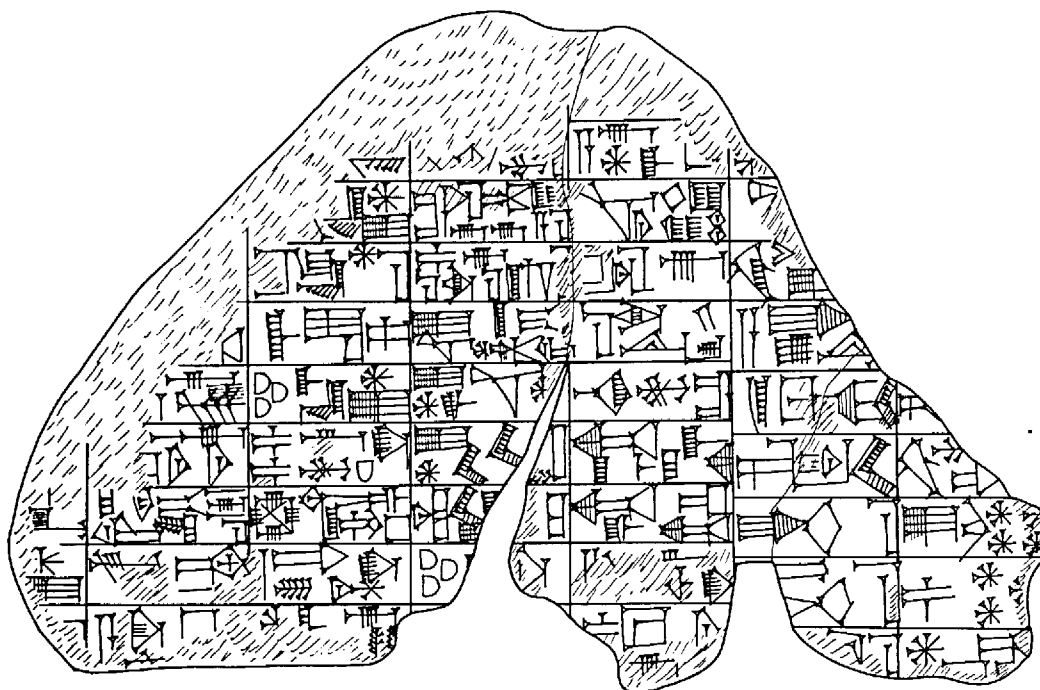

No. 392

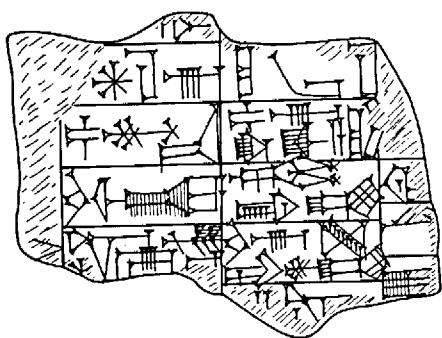

No. 393

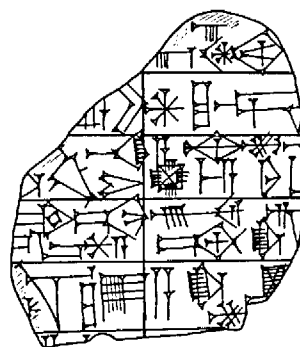

No. 394

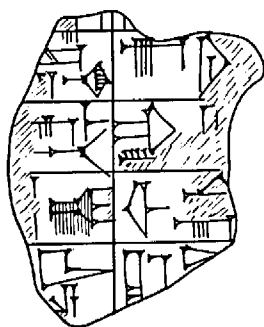

No. 395

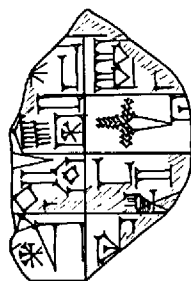

No. 396

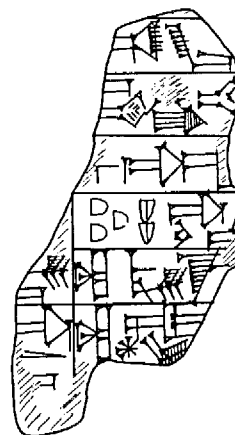

No. 397

PLATE 162

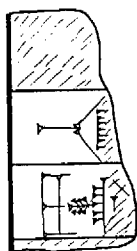

No. 398

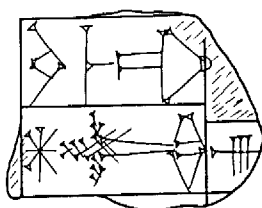

No. 399

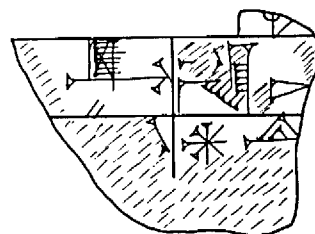

No. 400

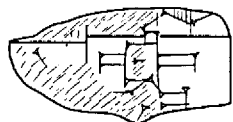

No. 401

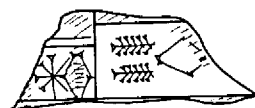

No. 402

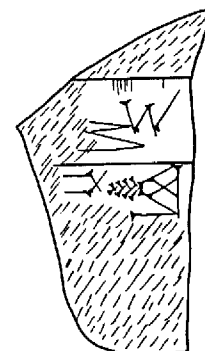

No. 403

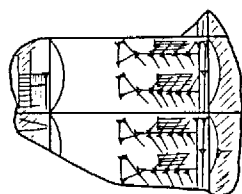

No. 404

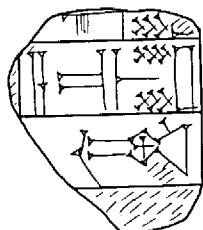

No. 405

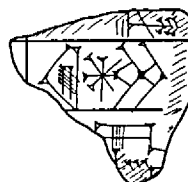

No. 406

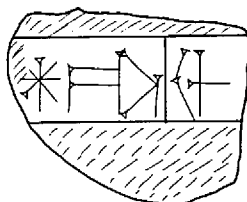

No. 407

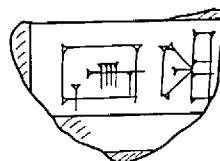

No. 408

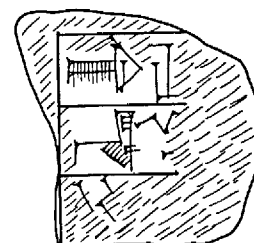

No. 409



No. 410

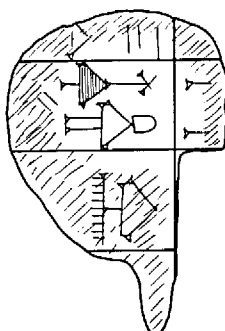

No. 411

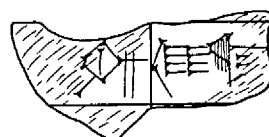

No. 412

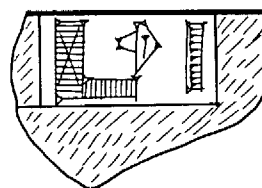

No. 413



No. 414

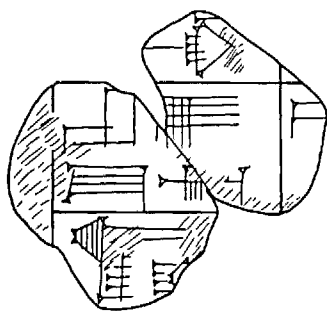

No. 415

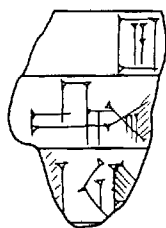

No. 416

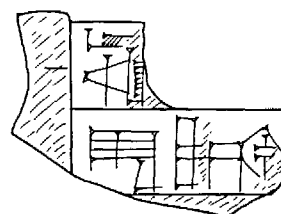

No. 417

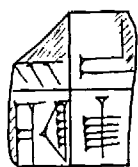

No. 418

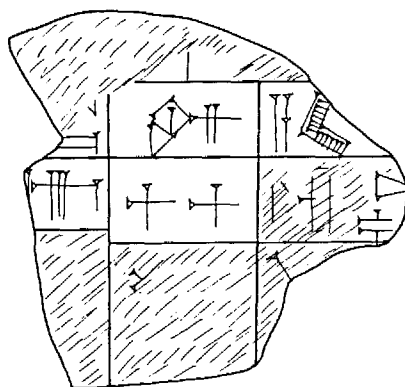

No. 419

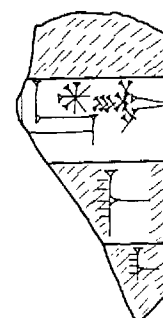

No. 420

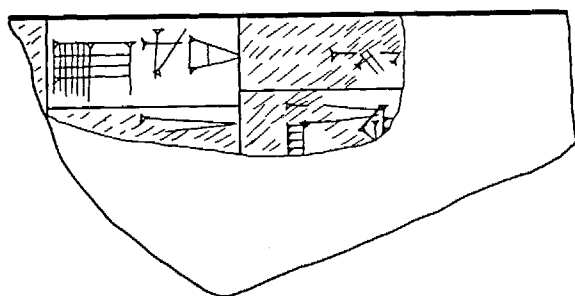

No. 421

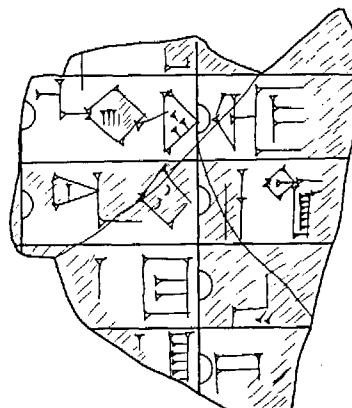

No. 422

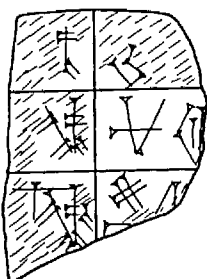

No. 423

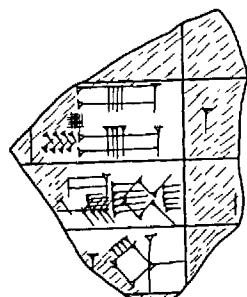

No. 424

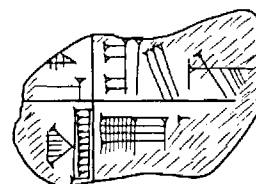

No. 425

PLATE 164

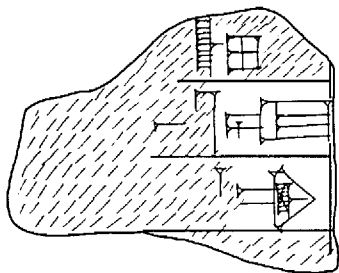

No. 426

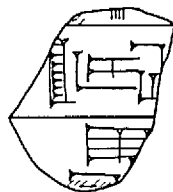

No. 427



No. 428

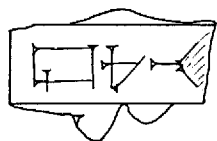

No. 429

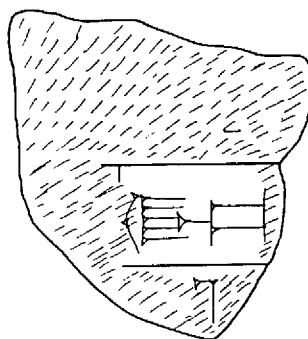

No. 430

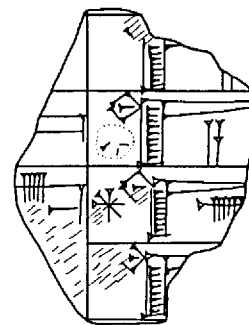

No. 431

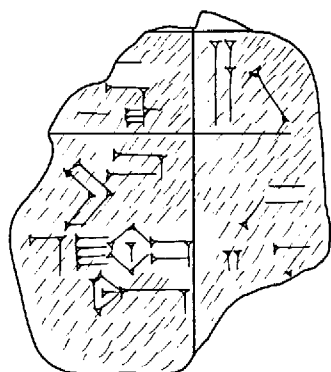

No. 432

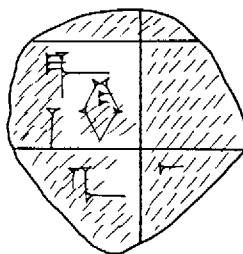

No. 433

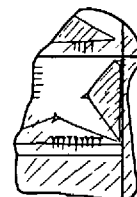

No. 434

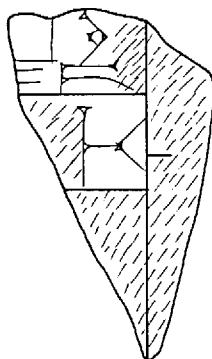

No. 435

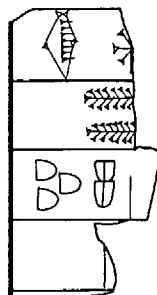

No. 436

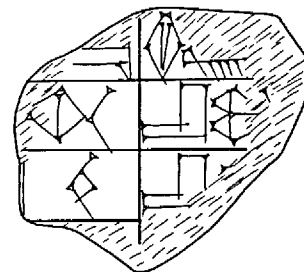

No. 437

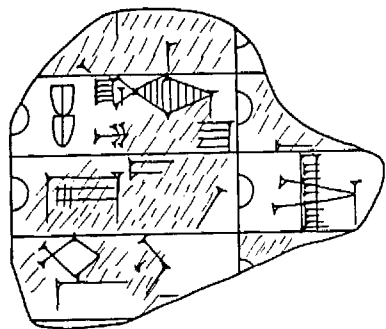

No. 438

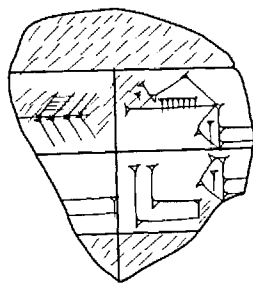

No. 439

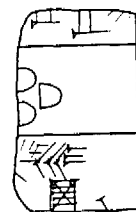

No. 440

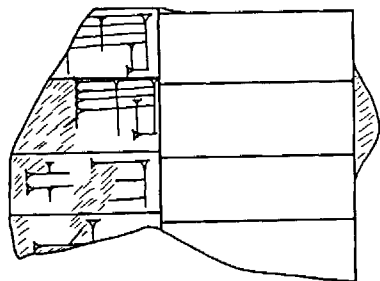

No. 441



No. 442

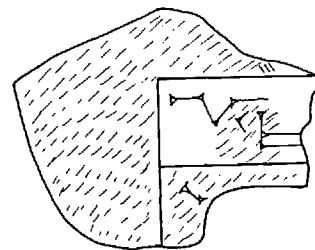

No. 443



No. 444

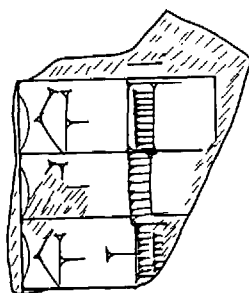

No. 445

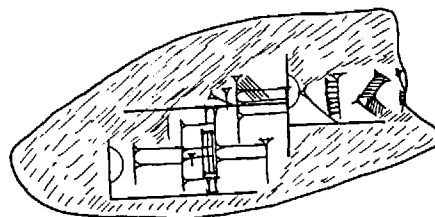

No. 446



Obverse
No. 460



Reverse
No. 460

PLATE 168



Obverse
No. 461



Reverse
No. 461



Obverse
No. 462



Reverse
No. 462

PLATE 170



Obverse
No. 463



Reverse
No. 463

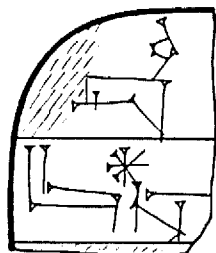

No. 464

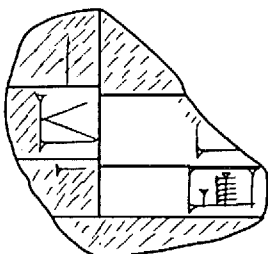

No. 465

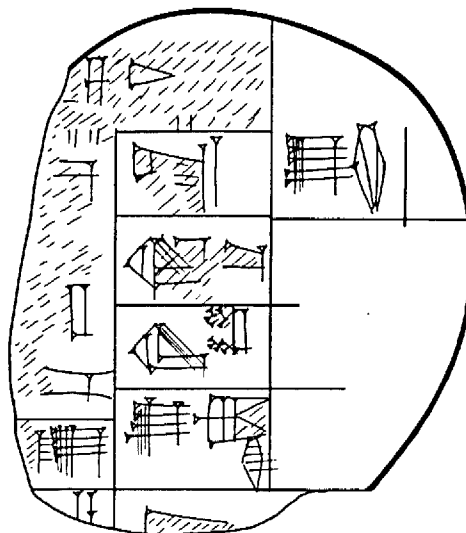

No. 466

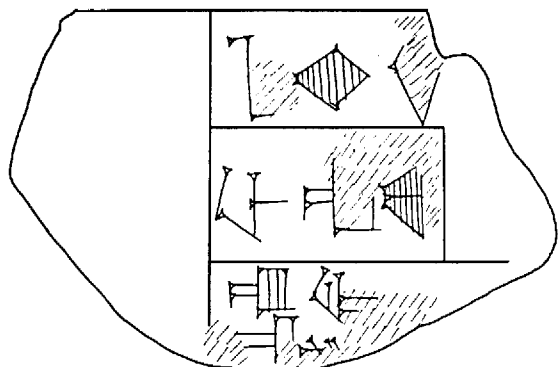

No. 467

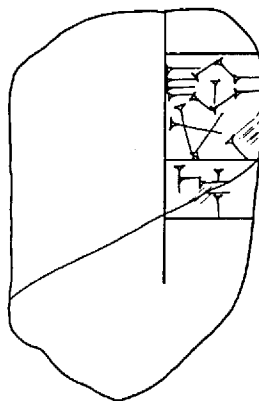

No. 468

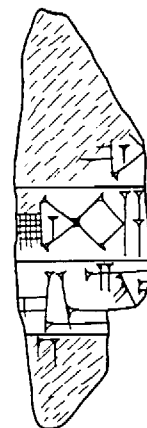

No. 469

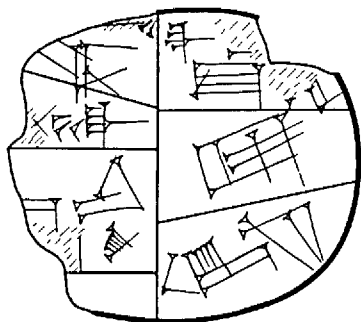

No. 470

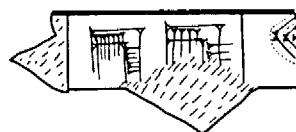

No. 471

PLATE 172

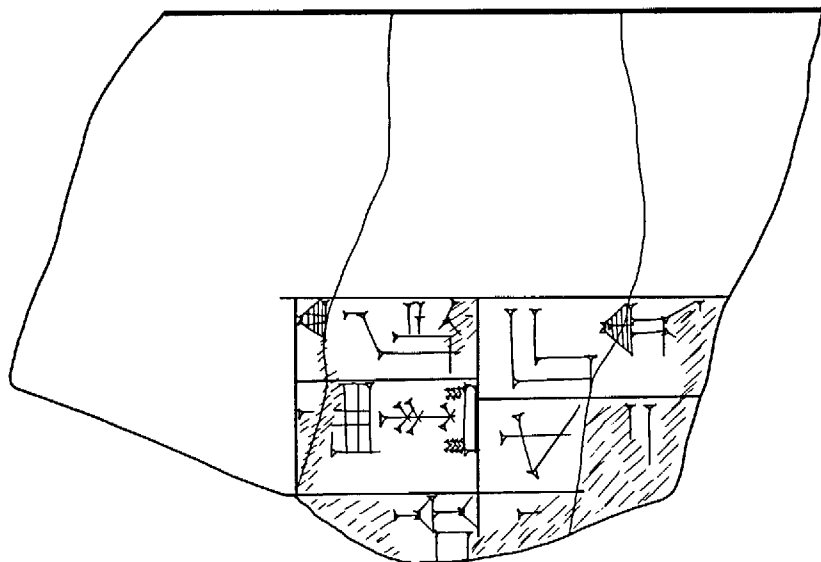

No. 472

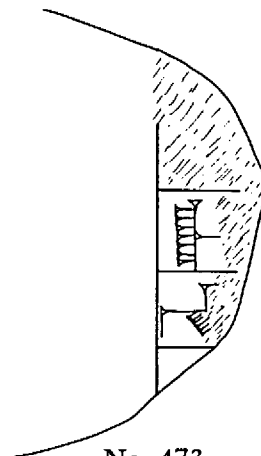

No. 473

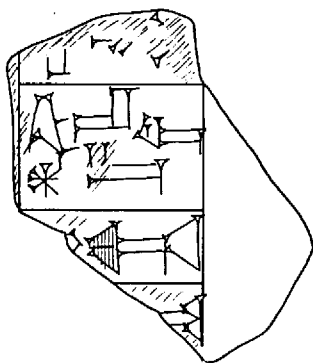

No. 474

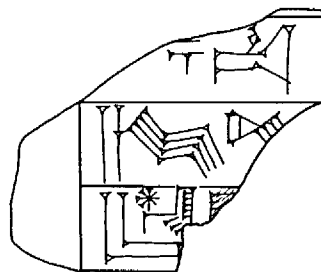

No. 475

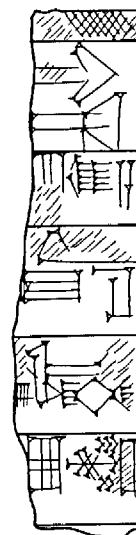

No. 476

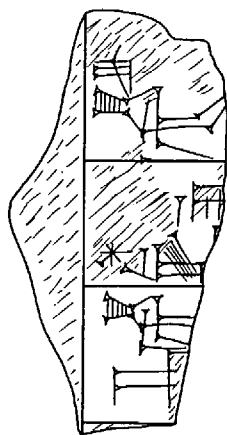

No. 477

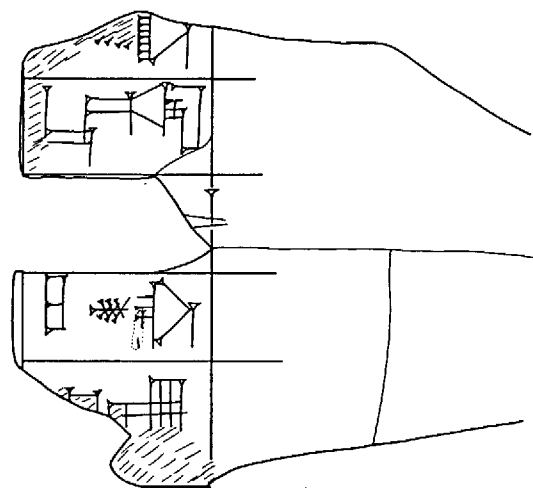

No. 478

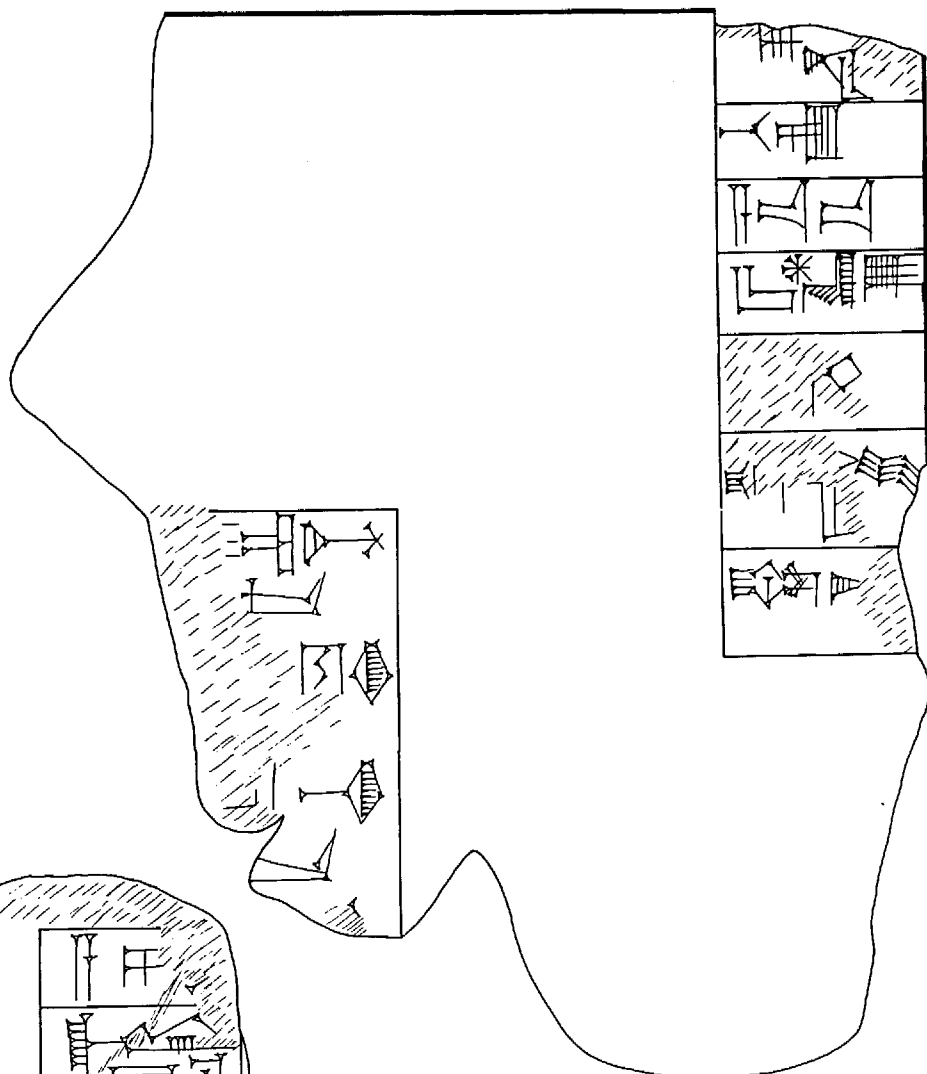

No. 479

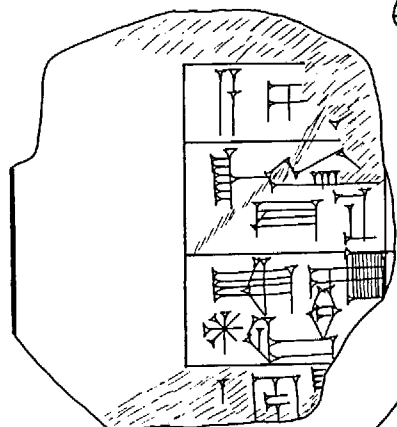

No. 480

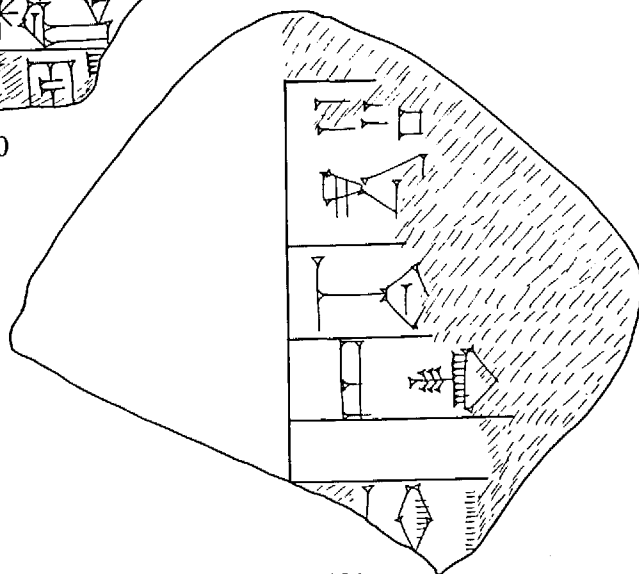

No. 481

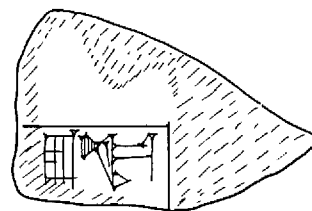

No. 482

PLATE 174

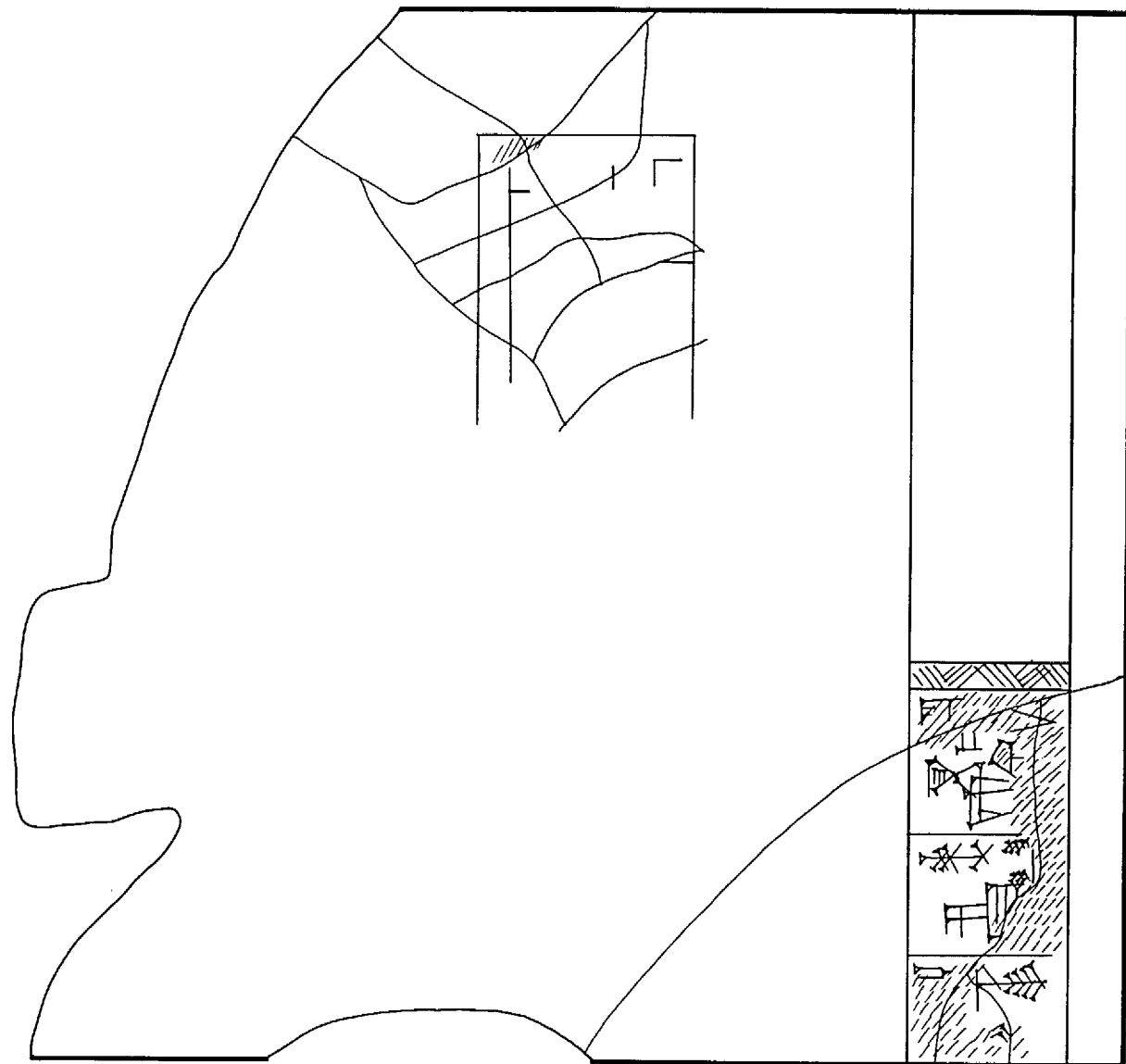

No. 483

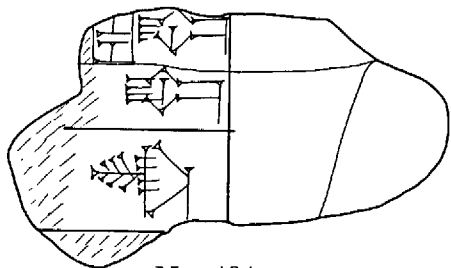

No. 484

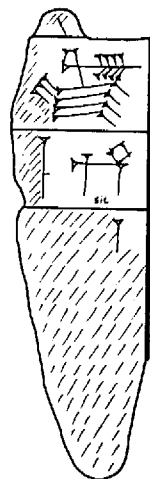

No. 485



No. 486

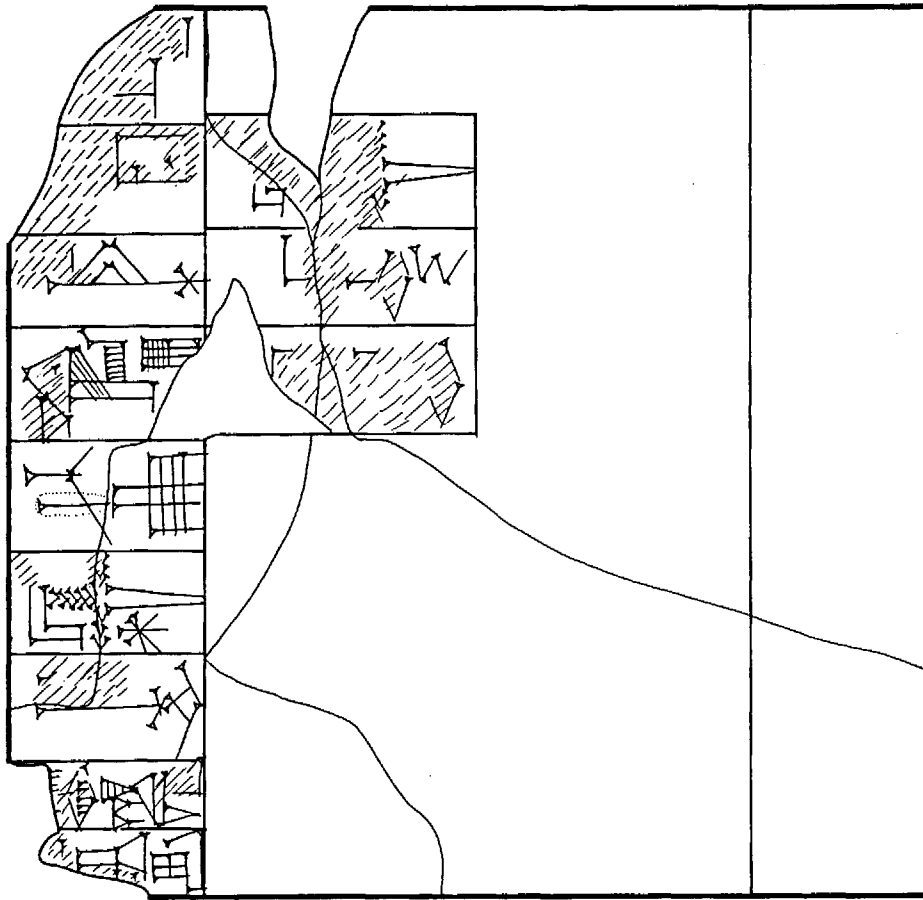

No. 487

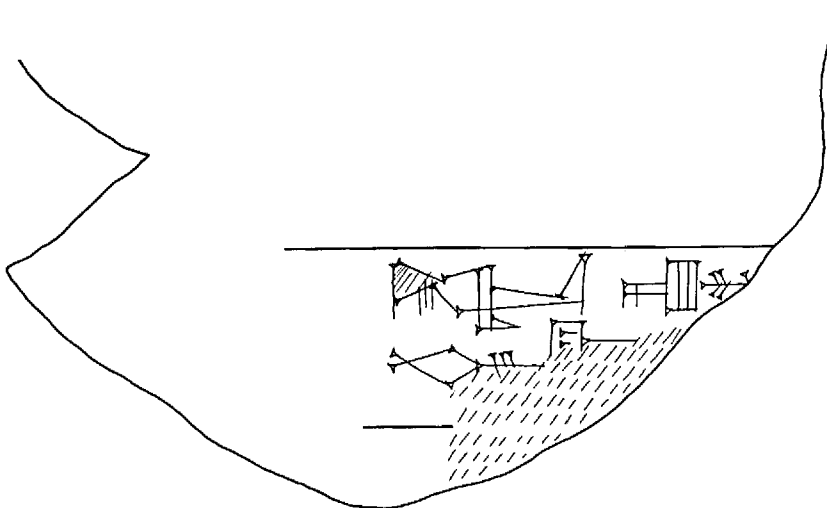

No. 488

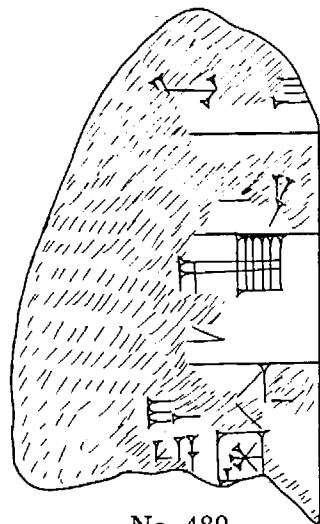

No. 489

PLATE 176



Obverse
No. 490



Reverse
No. 490



No. 491



No. 492

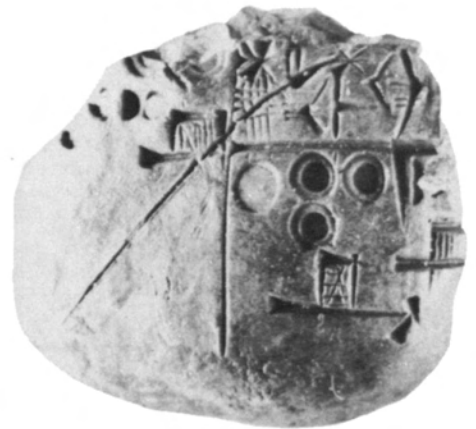

No. 493



Obverse
No. 494



Reverse
No. 494



Obverse
No. 495



Reverse
No. 495

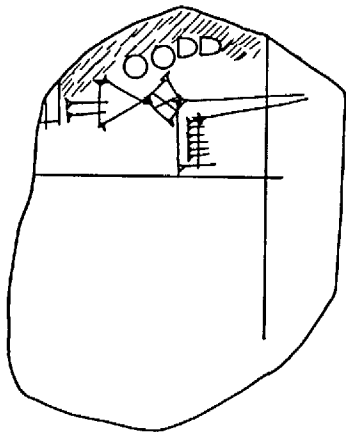

No. 496

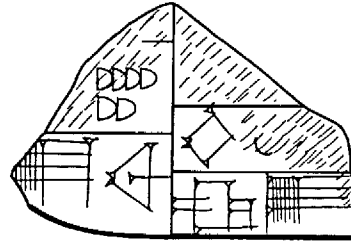

Obverse
No. 497

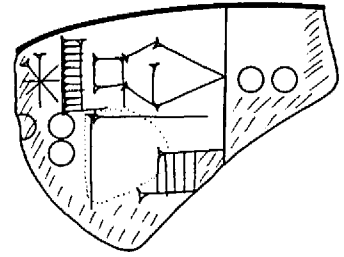

Reverse
No. 497

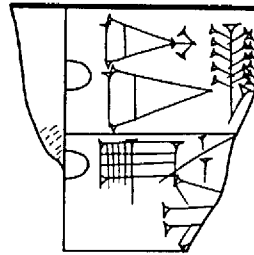

Obverse
No. 498

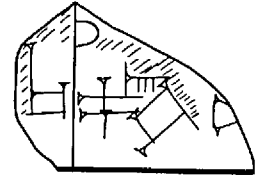

Reverse
No. 498

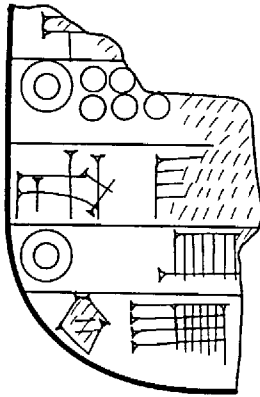

No. 499

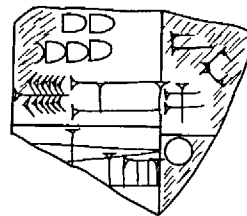

No. 500

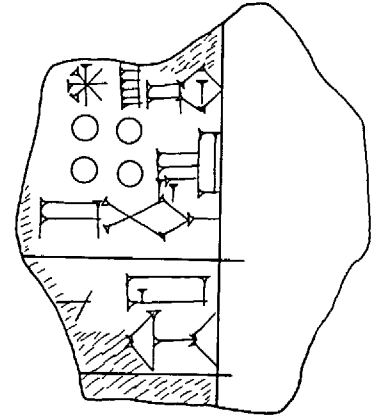

No. 501

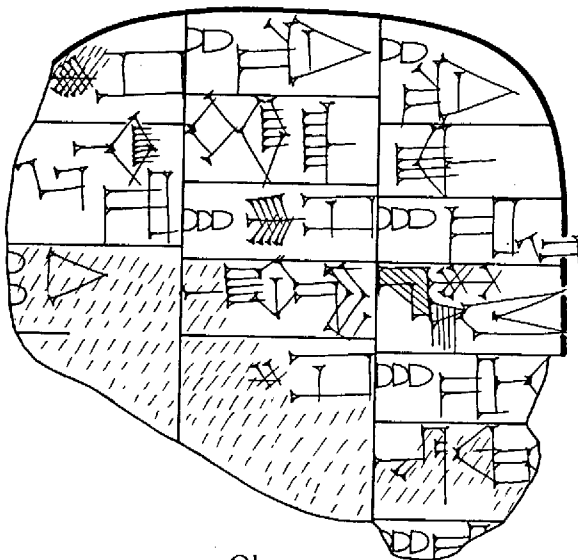

Obverse
No. 502

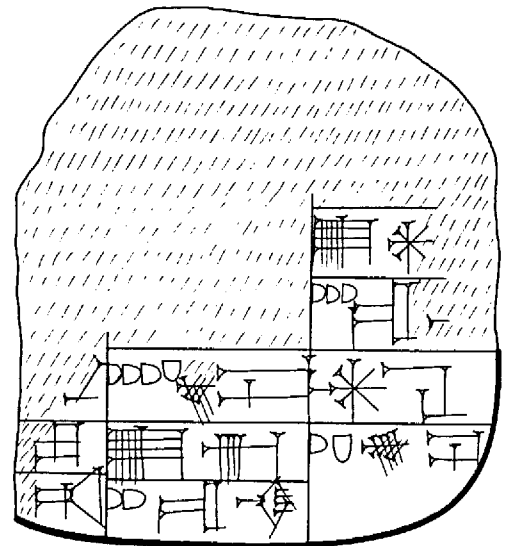

Reverse
No. 502

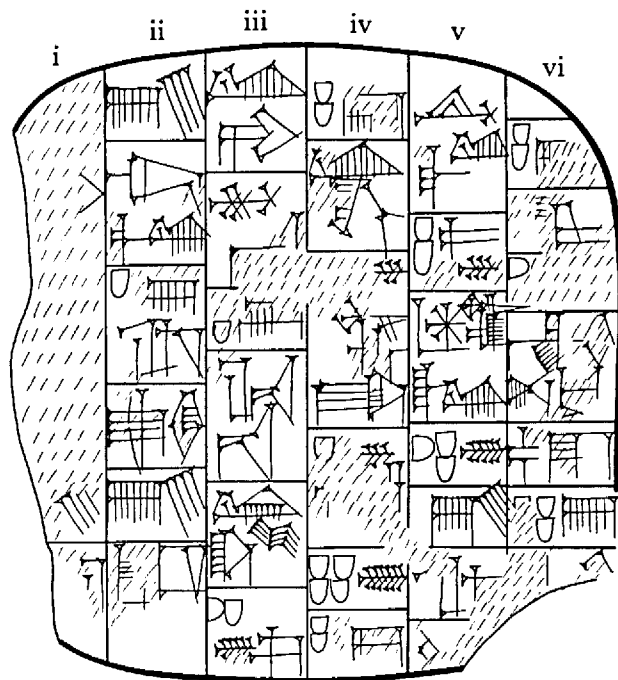

Obverse
No. 503

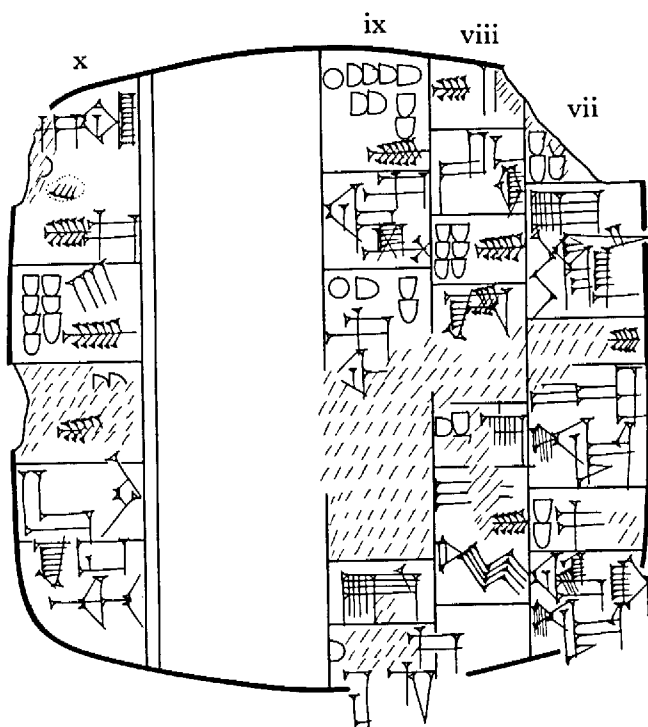

Reverse
No. 503

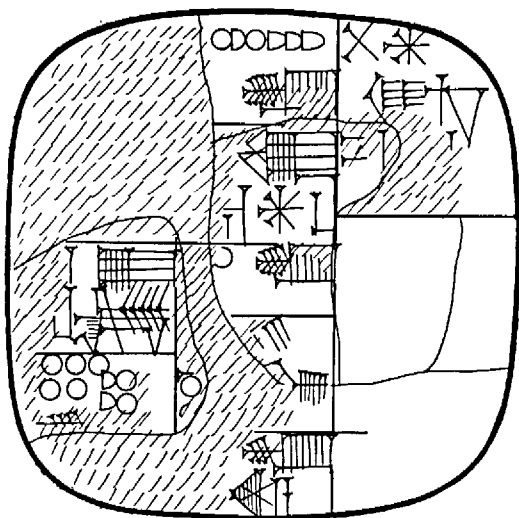

Obverse
No. 504

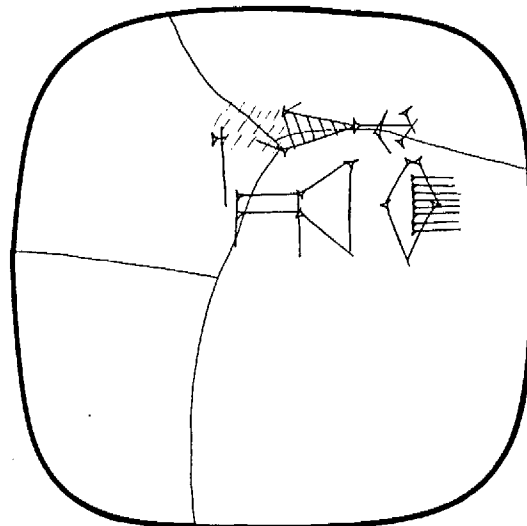

Reverse
No. 504

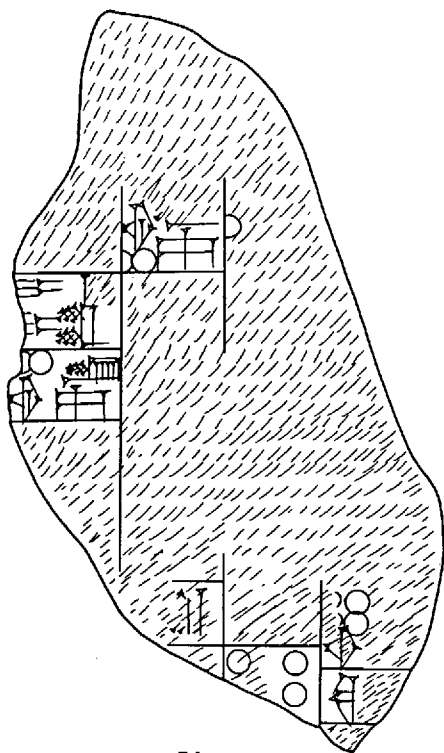

Obverse
No. 505

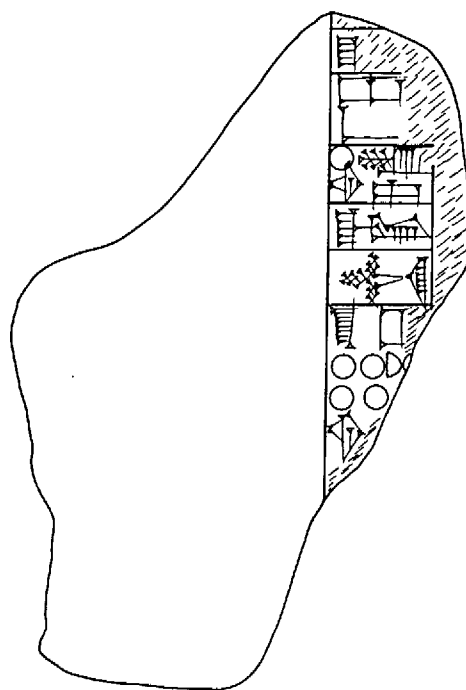

Reverse
No. 505

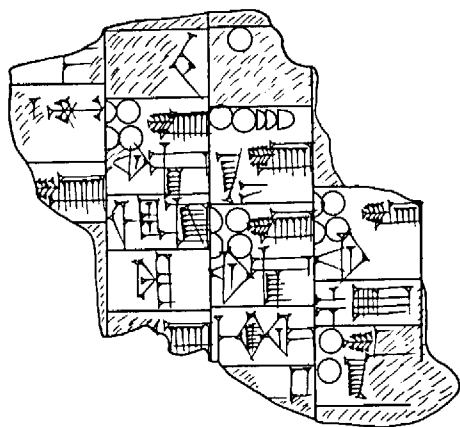

No. 506

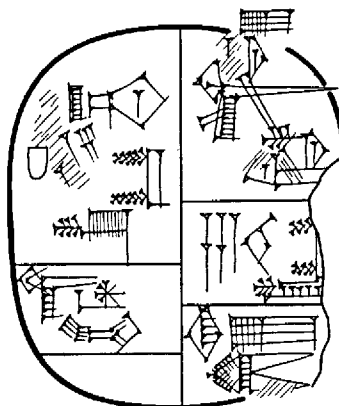

No. 507

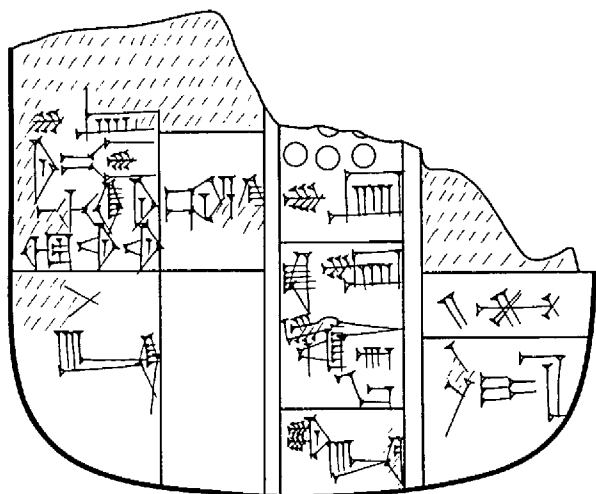

Obverse
No. 508



No. 509

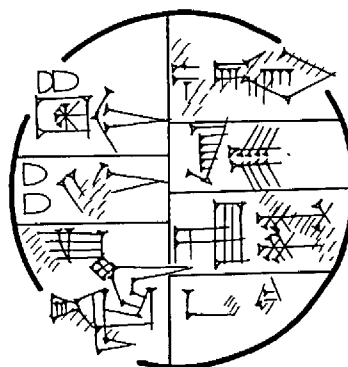

Obverse
No. 510

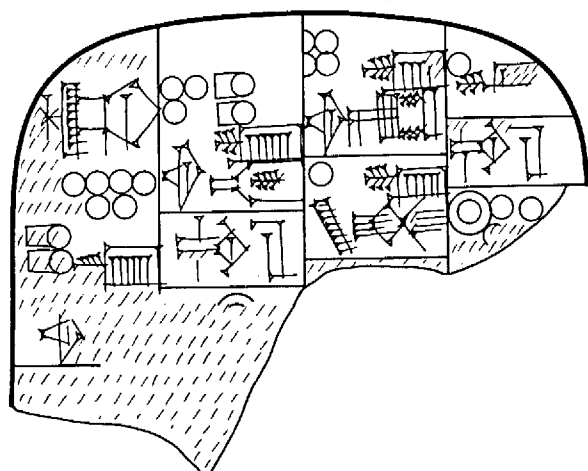

Reverse
No. 508

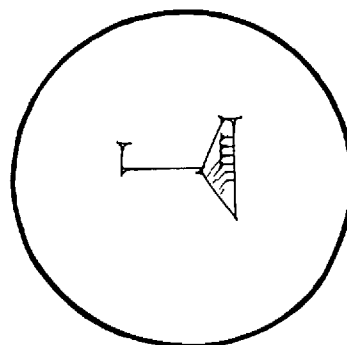

Reverse
No. 510

PLATE 182

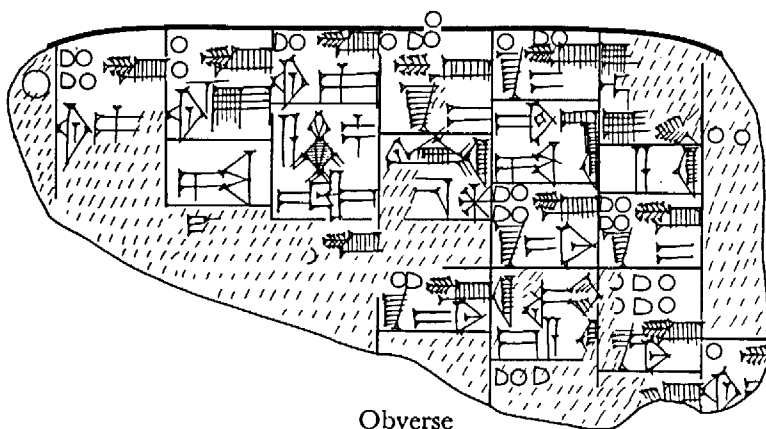

Obverse
No. 511

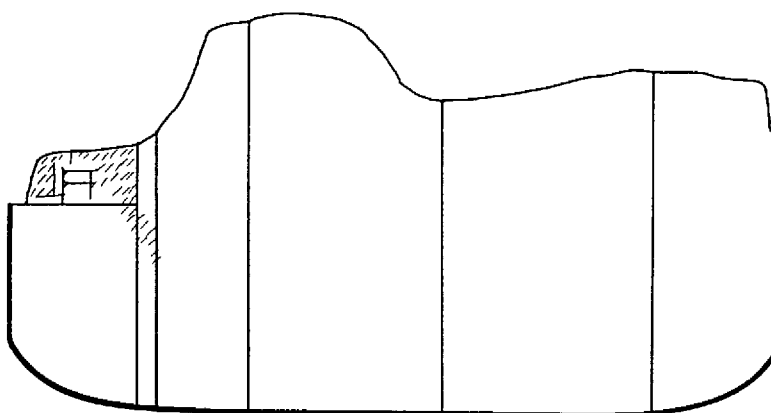

Reverse
No. 511

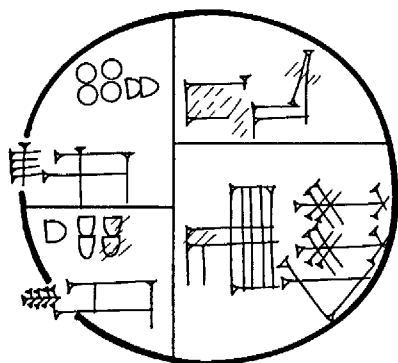

Obverse
No. 512

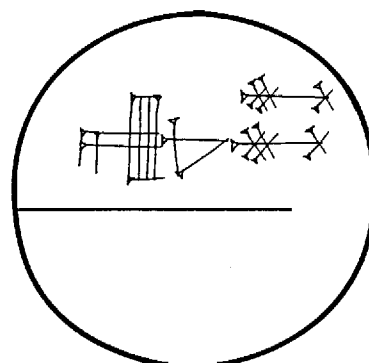

Reverse
No. 512

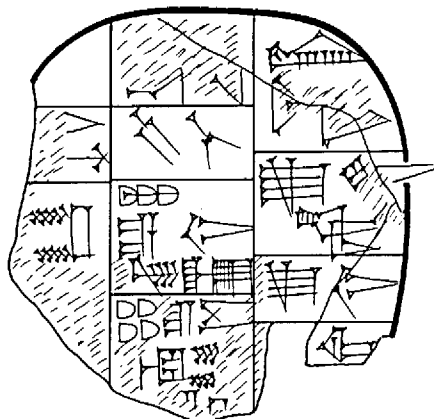

Obverse
No. 513

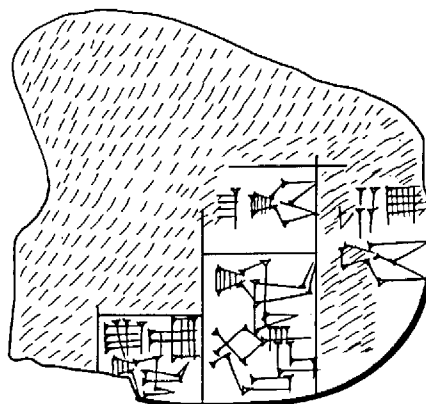

Reverse
No. 513

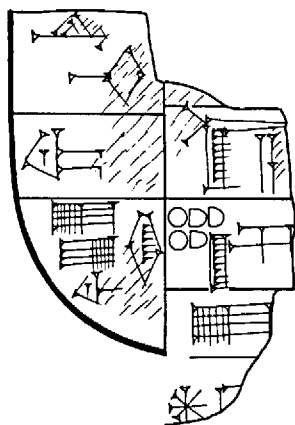

No. 514

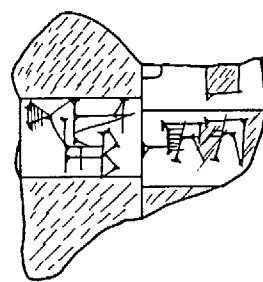

No. 515

TYPE COMPOSED BY WILLIAM CLOWES & SONS, LTD.,
LONDON
PRINTED BY PHOTOPRESS, INC., BROADVIEW, ILLINOIS

